

## I

(Acts whose publication is obligatory)

**COMMISSION REGULATION (EC) No 1360/2002****of 13 June 2002****adapting for the seventh time to technical progress Council Regulation (EEC) No 3821/85 on recording equipment in road transport****(Text with EEA relevance)**

THE COMMISSION OF THE EUROPEAN COMMUNITIES,

Having regard to the Treaty establishing the European Community,

Having regard to Council Regulation (EEC) No 3821/85 of 20 December 1985 on recording equipment in road transport <sup>(1)</sup>, as last amended by Regulation (EC) No 2135/98 <sup>(2)</sup>, and in particular Articles 17 and 18 thereof,

Whereas:

- (1) The technical specifications of Annex I (B) to Regulation (EEC) No 3821/85 should be adapted to technical progress paying particular attention to the overall security of the system and to the interoperability between the recording equipment and the driver cards.
- (2) The adaptation of the equipment also requires an adaptation of Annex II to Regulation (EEC) No 3821/85, which defines the marks and approval certificates.
- (3) The Committee set up by Article 18 of Regulation (EEC) No 3821/85 did not deliver an opinion on the measures provided in the proposal and the Commission therefore submitted to the Council a proposal relating to these measures.
- (4) On the expiry of the period laid down in Article 18(5)(b) of Regulation (EEC) No 3821/85, the Council had not acted and it is accordingly for the Commission to adopt these measures,

HAS ADOPTED THIS REGULATION:

*Article 1*

The Annex to Regulation (EC) No 2135/98 is replaced by the Annex to this Regulation.

*Article 2*

Annex II to Regulation (EEC) No 3821/85 is amended as follows:

1. Chapter I, item 1, first subparagraph is amended as follows:
  - the conventional sign for Greece 'GR' is replaced by '23',
  - the conventional sign for Ireland 'IRL' is replaced by '24',
  - the conventional sign for '12' is to be added for Austria,
  - the conventional sign for '17' is to be added for Finland,
  - the conventional sign for '5' is to be added for Sweden.
2. Chapter I, item 1, second subparagraph is amended as follows:
  - the wording 'or of a tachograph card' is inserted after the words 'record sheet'.
3. Chapter I, item 2 is amended as follows:
  - the wording 'and on each tachograph card' is inserted after the words 'record sheet'.
4. In Chapter II, the following wording is added to the title 'FOR PRODUCTS COMPLIANT WITH ANNEX I'.

<sup>(1)</sup> OJ L 370, 31.12.1985, p. 8.

<sup>(2)</sup> OJ L 274, 9.10.1998, p. 1.

## 5. The following Chapter III is added:

## III. APPROVAL CERTIFICATE FOR PRODUCTS COMPLIANT WITH ANNEX I B

A State, having granted approval, shall issue the applicant with an approval certificate, the model of which is given below. When informing other Member States of approvals issued or, if the occasion should arise, withdrawn, a Member State shall use copies of that certificate.

---

 APPROVAL CERTIFICATE FOR PRODUCTS COMPLIANT WITH ANNEX I B
 

---

Name of competent administration .....

Notification concerning <sup>(3)</sup>:

- approval of
- withdrawal of approval of
- recording equipment model
- recording equipment component <sup>(4)</sup> .....
- a driver's card
- a workshop card
- a company card
- a controller's card

Approval No .....

1. Manufacturing brand or trademark .....
2. Name of model .....
3. Name of manufacturer .....
4. Address of manufacturer .....
5. Submitted for approval for .....
6. Laboratory(ies) .....
7. Date and number of the test(s) .....
8. Date of approval .....
9. Date of withdrawal of approval .....
10. Model of recording equipment component(s) with which the component is designed to be used
11. Place .....
12. Date .....
13. Descriptive documents annexed .....

---

 14. Remarks (including the position of seals if applicable)

.....  
 (signature)

---

<sup>(3)</sup> Tick the relevant boxes.
<sup>(4)</sup> Specify the component dealt with in the notification.

*Article 3*

This Regulation shall enter into force on the twentieth day following that of its publication in the *Official Journal of the European Communities*.

This Regulation shall be binding in its entirety and directly applicable in all Member States.

Done at Brussels, 13 June 2002.

*For the Commission*  
Loyola DE PALACIO  
*Vice-President*

---

## ANNEX

## ANNEX I B

**REQUIREMENTS FOR CONSTRUCTION, TESTING, INSTALLATION AND INSPECTION**

## CONTENTS

I.	DEFINITIONS .....	8
II.	GENERAL CHARACTERISTICS AND FUNCTIONS OF THE RECORDING EQUIPMENT .....	12
	1. General characteristics .....	12
	2. Functions .....	12
	3. Modes of operation .....	13
	4. Security .....	14
III.	CONSTRUCTION AND FUNCTIONAL REQUIREMENTS FOR RECORDING EQUIPMENT .....	14
	1. Monitoring cards insertion and withdrawal .....	14
	2. Speed and distance measurement .....	14
	2.1. Measurement of distance travelled .....	15
	2.2. Measurement of speed .....	15
	3. Time measurement .....	15
	4. Monitoring driver activities .....	16
	5. Monitoring driving status .....	16
	6. Drivers manual entries .....	16
	6.1. Entry of places where daily work periods begin and/or end .....	16
	6.2. Manual entry of driver activities .....	16
	6.3. Entry of specific conditions .....	18
	7. Company locks management .....	18
	8. Monitoring control activities .....	18
	9. Detection of events and/or faults .....	18
	9.1. "Insertion of a non valid card" event .....	18
	9.2. "Card conflict" event .....	19
	9.3. "Time overlap" event .....	19
	9.4. "Driving without an appropriate card" event .....	19
	9.5. "Card insertion while driving" event .....	19
	9.6. "Last card session not correctly closed" event .....	19
	9.7. "Over speeding" event .....	19

9.8.	“Power supply interruption” event .....	20
9.9.	“Motion data error” event .....	20
9.10.	“Security breach attempt” event .....	20
9.11.	“Card” fault .....	20
9.12.	“Recording equipment” fault .....	20
10.	Built-in and self tests .....	20
11.	Reading from data memory .....	21
12.	Recording and storing in the data memory .....	21
12.1.	Equipment identification data .....	21
12.1.1.	Vehicle Unit identification data .....	21
12.1.2.	Motion sensor identification data .....	22
12.2.	Security elements .....	22
12.3.	Driver card insertion and withdrawal data .....	22
12.4.	Driver activity data .....	23
12.5.	Places where daily work periods start and/or end .....	23
12.6.	Odometer data .....	23
12.7.	Detailed speed data .....	23
12.8.	Events data .....	23
12.9.	Faults data .....	25
12.10.	Calibration data .....	26
12.11.	Time adjustment data .....	26
12.12.	Control activity data .....	26
12.13.	Company locks data .....	27
12.14.	Download activity data .....	27
12.15.	Specific conditions data .....	27
13.	Reading from tachograph cards .....	27
14.	Recording and storing on tachograph cards .....	27
15.	Displaying .....	28
15.1	Default display .....	28
15.2.	Warning display .....	29
15.3.	Menu access .....	29
15.4.	Other displays .....	29
16.	Printing .....	29
17.	Warnings .....	30
18.	Data downloading to external media .....	31
19.	Output data to additional external devices .....	31
20.	Calibration .....	32
21.	Time adjustment .....	32

22.	Performance characteristics .....	32
23.	Materials .....	32
24.	Markings .....	33
IV.	CONSTRUCTIONS AND FUNCTIONAL REQUIREMENTS FOR TACHOGRAPH CARDS .....	33
1.	Visible data .....	33
2.	Security .....	36
3.	Standards .....	36
4.	Environmental and electrical specifications .....	36
5.	Data storage .....	36
5.1.	Card identification and security data .....	37
5.1.1.	Application identification .....	37
5.1.2.	Chip identification .....	37
5.1.3.	IC card identification .....	37
5.1.4.	Security elements .....	37
5.2.	Driver card .....	37
5.2.1.	Card identification .....	37
5.2.2.	Card holder identification .....	38
5.2.3.	Driving licence information .....	38
5.2.4.	Vehicles used data .....	38
5.2.5.	Driver activity data .....	38
5.2.6.	Places where daily periods start and/or end .....	39
5.2.7.	Events data .....	39
5.2.8.	Faults data .....	40
5.2.9.	Control activity data .....	40
5.2.10.	Card session data .....	40
5.2.11.	Specific conditions data .....	40
5.3.	Workshop card .....	41
5.3.1.	Security elements .....	41
5.3.2.	Card identification .....	41
5.3.3.	Card holder identification .....	41
5.3.4.	Vehicles' used data .....	41
5.3.5.	Driver activity data .....	41
5.3.6.	Daily work periods start and/or end data .....	41
5.3.7.	Events and faults data .....	41
5.3.8.	Control activity data .....	41
5.3.9.	Calibration and time adjustment data .....	42
5.3.10.	Specific conditions data .....	42
5.4.	Control card .....	42

5.4.1.	Card identification .....	42
5.4.2.	Card holder identification .....	42
5.4.3.	Control activity data .....	42
5.5.	Company card .....	43
5.5.1.	Card identification .....	43
5.5.2.	Card holder identification .....	43
5.5.3.	Company activity data .....	43
V.	INSTALATION OF RECORDING EQUIPMENT .....	43
1.	Installation .....	43
2.	Installation plaque .....	44
3.	Sealing .....	44
VI.	CHECKS; INSPECTIONS AND REPAIRS .....	45
1.	Approval of fitters or workshops .....	45
2.	Check of new or repaired instruments .....	45
3.	Installation inspection .....	45
4.	Periodic inspections .....	45
5.	Measurement of errors .....	46
6.	Repairs .....	46
VII.	CARD ISSUING .....	46
VIII.	TYPE APPROVAL OF RECORDING EQUIPMENT AND TACHOGRAPH CARDS .....	46
1.	General points .....	46
2.	Security certificate .....	47
3.	Functional certificate .....	47
4.	Interoperability certificate .....	47
5.	Type approval certificate .....	48
6.	Exceptional procedure: first interoperability tests .....	48
Appendix 1.	Data dictionary	
Appendix 2.	Tachograph cards specification	
Appendix 3.	Pictograms	
Appendix 4.	Printouts	
Appendix 5.	Display	
Appendix 6.	External interfaces	
Appendix 7.	Data downloading protocol	
Appendix 8.	Calibration protocol	
Appendix 9.	TYPE APPROVAL — LIST OF MINIMUM REQUIRED TESTS	
Appendix 10.	GENERIC SECURITY TARGETS	
Appendix 11.	COMMON SECURITY MECHANISMS	

## I. DEFINITIONS

In this Annex:

(a) **“activation” means:**

phase where the recording equipment becomes fully operational and implements all functions, including security functions;

*Activating a recording equipment requires the use of a workshop card and the entry of its PIN code;*

(b) **“authentication” means:**

a function intended to establish and verify a claimed identity;

(c) **“authenticity” means:**

the property that an information is coming from a party whose identity can be verified;

(d) **“built-in-test (BIT)” means:**

tests run at request, triggered by the operator or by an external equipment;

(e) **“calendar day” means:**

a day ranging from 00.00 hours to 24.00 hours. All calendar days relate to UTC time (universal time coordinated);

(f) **“calibration” means:**

updating or confirming vehicle parameters to be held in the data memory. Vehicle parameters include vehicle identification (VIN, VRN and registering Member State) and vehicle characteristics (w, k, l, tyre size, speed limiting device setting (if applicable), current UTC time, current odometer value);

*calibrating a recording equipment requires the use of a workshop card;*

(g) **“card number” means:**

a 16 alpha-numerical characters number that uniquely identifies a tachograph card within a Member State. The card number includes a consecutive index (if applicable), a replacement index and a renewal index;

a card is therefore uniquely identified by the code of the issuing Member State and the card number;

(h) **“card consecutive index” means:**

the 14th alpha-numerical character of a card number that is used to differentiate the different cards issued to a company or a body entitled to be issued several tachograph cards. The company or the body is uniquely identified by the 13 first characters of the card number;

(i) **“card renewal index” means:**

the 16th alpha-numerical character of a card number which is incremented each time a tachograph card is renewed;

(j) **“card replacement index” means:**

the 15th alpha-numerical character of a card number which is incremented each time a tachograph card is replaced;

(k) **“characteristic coefficient of the vehicle” means:**

the numerical characteristic giving the value of the output signal emitted by the part of the vehicle linking it with the recording equipment (gearbox output shaft or axle) while the vehicle travels a distance of one kilometre under standard test conditions (see Chapter VI(5)). The characteristic coefficient is expressed in impulses per kilometre (w = ... imp/km);



(l) **“company card” means:**

a tachograph card issued by the authorities of a Member State to the owner or holder of vehicles fitted with recording equipment;

*the company card identifies the company and allows for displaying, downloading and printing of the data stored in the recording equipment which has been locked by this company;*

(m) **“constant of the recording equipment” means:**

the numerical characteristic giving the value of the input signal required to show and record a distance travelled of one kilometre; this constant shall be expressed in impulses per kilometre ( $k = \dots \text{imp/km}$ );

(n) **“continuous driving time” is computed within the recording equipment as <sup>(1)</sup>:**

the continuous driving time is computed as the current accumulated driving times of a particular driver, since the end of his last AVAILABILITY or BREAK/REST or UNKNOWN <sup>(2)</sup> period of 45 minutes or more (this period may have been split in several periods of 15 minutes or more). The computations involved take into account, as needed, past activities stored on the driver card. When the driver has not inserted his card, the computations involved are based on the data memory recordings related to the current period where no card was inserted and related to the relevant slot;

(o) **“control card” means:**

a tachograph card issued by the authorities of a Member State to a national competent control authority;

*the control card identifies the control body and possibly the control officer and allows for getting access to the data stored in the data memory or in the driver cards for reading, printing and/or downloading;*

(p) **“cumulative break time” is computed within the recording equipment as <sup>(1)</sup>:**

the cumulative break from driving time is computed as the current accumulated AVAILABILITY or BREAK/REST or UNKNOWN <sup>(2)</sup> times of 15 minutes or more of a particular driver, since the end of his last AVAILABILITY or BREAK/REST or UNKNOWN <sup>(2)</sup> period of 45 minutes or more (this period may have been split in several periods of 15 minutes or more).

The computations involved take into account, as needed, past activities stored on the driver card. Unknown periods of negative duration (start of unknown period > end of unknown period) due to time overlaps between two different recording equipments, are not taken into account for the computation.

When the driver has not inserted his card, the computations involved are based on the data memory recordings related to the current period where no card was inserted and related to the relevant slot;

(q) **“data memory” means:**

an electronic data storage device built into the recording equipment;

(r) **“digital signature” means:**

data appended to, or a cryptographic transformation of, a block of data that allows the recipient of the block of data to prove the authenticity and integrity of the block of data;

(s) **“downloading” means:**

copying together with digital signature of a part or of a complete set of data stored in the data memory of the vehicle or in the memory of a tachograph card;

*downloading may not alter or delete any stored data;*

<sup>(1)</sup> This way of computing the continuous driving time and the cumulative break time serves into the recording equipment for computing the continuous driving time warning. It does not prejudice the legal interpretation to be made of these times.

<sup>(2)</sup> UNKNOWN periods correspond to periods where the driver's card was not inserted in a recording equipment and for which no manual entry of driver activities was made.

- (t) **“driver card” means:**
- a tachograph card issued by the authorities of a Member State to a particular driver;
- the driver card identifies the driver and allows for storage of driver activity data;*
- (u) **“effective circumference of the wheel tyres” means:**
- the average of the distances travelled by each of the wheels moving the vehicle (driving wheels) in the course of one complete rotation. The measurement of these distances shall be made under standard test conditions (Chapter VI(5)) and is expressed in the form “l = ... mm”. Vehicle manufacturers may replace the measurement of these distances by a theoretical calculation which takes into account the distribution of the weight on the axles, vehicle unladen in normal running order <sup>(1)</sup>. The methods for such theoretical calculation will be approved by a competent Member State authority;
- (v) **“event” means:**
- abnormal operation detected by the recording equipment which may come from a fraud attempt;
- (w) **“fault” means:**
- abnormal operation detected by the recording equipment which may come from an equipment malfunction or failure;
- (x) **“installation” means:**
- mounting of the recording equipment in a vehicle;
- (y) **“motion sensor” means:**
- part of the recording equipment, providing a signal representative of vehicle speed and/or distance travelled;
- (z) **“non valid card” means:**
- a card detected as faulty, or which initial authentication failed, or which start of validity date is not yet reached, or which expiry date has passed;
- (aa) **“out of scope” means:**
- when the use of the recording equipment is not required, according to the provisions of Council Regulation (EEC) No 3820/85;
- (bb) **“over speeding” means:**
- exceeding the authorised speed of the vehicle, defined as any period of more than 60 seconds during which the vehicle's measured speed exceeds the limit for setting the speed limitation device laid down in Council Directive 92/6/EEC of 10 February 1992 on the installation and use of speed limitation devices for certain categories of motor vehicles in the Community <sup>(2)</sup>;
- (cc) **“periodic inspection” means:**
- set of operations performed to control that the recording equipment works properly and that its settings correspond to the vehicle parameters;
- (dd) **“printer” means:**
- component of the recording equipment which provides printouts of stored data;
- (ee) **“recording equipment” means:**
- the total equipment intended for installation in road vehicles to show, record and store automatically or semi-automatically details of the movement of such vehicles and of certain work periods of their drivers;

<sup>(1)</sup> Directive 97/27/EC of 22 July 1997 relating to the masses and dimensions of certain categories of motor vehicles and their trailers and amending Directive 70/156/EEC (OJ L 233, 25.8.1997, p. 1).

<sup>(2)</sup> OJ L 57, 2.3.1992, p. 27.

(ff) **“renewal” means:**

issue of a new tachograph card when an existing card reaches its expiry date, or is malfunctioning and has been returned to the issuing authority. Renewal always implies the certainty that two valid cards do not co-exist;

(gg) **“repair” means:**

any repair of a motion sensor or of a vehicle unit that requires disconnection of its power supply, or disconnection from other recording equipment components, or opening of it;

(hh) **“replacement” means:**

issue of a tachograph card in replacement of an existing card, which has been declared lost, stolen or malfunctioning and has not been returned to the issuing authority. Replacement always implies a risk that two valid cards may co-exist;

(ii) **“security certification” means:**

process to certify, by an ITSEC <sup>(1)</sup> certification body, that the recording equipment (or component) or the tachograph card under investigation fulfils the security requirements defined in Appendix 10 Generic security targets;

(jj) **“self test” means:**

tests run cyclically and automatically by the recording equipment to detect faults;

(kk) **“tachograph card” means:**

smart card intended for use with the recording equipment. Tachograph cards allow for identification by the recording equipment of the identity (or identity group) of the cardholder and allow for data transfer and storage. A tachograph card may be of the following types:

- driver card,
- control card,
- workshop card,
- company card;

(ll) **“type approval” means:**

process to certify, by a Member State, that the recording equipment (or component) or the tachograph card under investigation fulfils the requirements of this regulation;

(mm) **“tyre size” means:**

the designation of the dimensions of the tyres (external driving wheels) in accordance with Directive 92/23/EEC of 31 March 1992 <sup>(2)</sup>;

(nn) **“vehicle identification” means:**

numbers identifying the vehicle: vehicle registration number (VRN) with indication of the registering Member State and vehicle identification number (VIN) <sup>(3)</sup>;

(oo) **“vehicle unit (VU)” means:**

the recording equipment excluding the motion sensor and the cables connecting the motion sensor. The vehicle unit may either be a single unit or be several units distributed in the vehicle, as long as it complies with the security requirements of this regulation;

<sup>(1)</sup> Council Recommendation 95/144/EC of 7 April 1995 on common information technology security evaluation criteria (OJ L 93, 26.4.1995, p. 27).

<sup>(2)</sup> OJ L 129, 14.5.1992, p. 95.

<sup>(3)</sup> Directive 76/114/EEC, of 18 December 1975 on the approximation of the laws of the Member States relating to statutory plates and inscriptions for motor vehicles and their trailers, and their location and method of attachment (OJ L 24, 30.1.1976, p. 1).

(pp) **for computing sake in the recording equipment “week” means:**

the period between 00.00 hours UTC on Monday and 24.00 UTC on Sunday;

(qq) **“workshop card” means:**

a tachograph card issued by the authorities of a Member State to a recording equipment manufacturer, a fitter, a vehicle manufacturer or workshop, approved by that Member State.

*The workshop card identifies the cardholder and allows for testing, calibration and/or downloading of the recording equipment;*

## II. GENERAL CHARACTERISTICS AND FUNCTIONS OF THE RECORDING EQUIPMENT

000 Any vehicle fitted with the recording equipment complying with the provisions of this Annex, must include a speed display and an odometer. These functions may be included within the recording equipment.

### 1. General characteristics

The purpose of the recording equipment is to record, store, display, print, and output data related to driver activities.

001 The recording equipment includes cables, a motion sensor, and a vehicle unit.

002 The vehicle unit includes a processing unit, a data memory, a real time clock, two smart card interface devices (driver and co-driver), a printer, a display, a visual warning, a calibration/downloading connector, and facilities for entry of user's inputs.

The recording equipment may be connected to other devices through additional connectors.

003 Any inclusion in or connection to the recording equipment of any function, device, or devices, approved or otherwise, shall not interfere with, or be capable of interfering with, the proper and secure operation of the recording equipment and the provisions of the Regulation.

Recording equipment users identify themselves to the equipment via tachograph cards.

004 The recording equipment provides selective access rights to data and functions according to user's type and/or identity.

The recording equipment records and stores data in its data memory and in tachograph cards.

This is done in accordance with Directive 95/46/EC of 24 October 1995 on the protection of individuals with regard to the processing of personal data and on the free movement of such data <sup>(1)</sup>.

### 2. Functions

005 The recording equipment shall ensure the following functions:

- monitoring cards insertions and withdrawals,
- speed and distance measurement,
- time measurement,
- monitoring driver activities,
- monitoring driving status,
- drivers manual entries:
  - entry of places where daily work periods begin and/or end,
  - manual entry of driver activities,
  - entry of specific conditions,

<sup>(1)</sup> OJ L 281, 23.11.1995, p. 31.

- company locks management,
- monitoring control activities,
- detection of events and/or faults,
- built-in and self tests,
- reading from data memory,
- recording and storing in data memory,
- reading from tachograph cards,
- recording and storing in tachograph cards,
- displaying,
- printing,
- warning,
- data downloading to external media,
- output data to additional external devices,
- calibration,
- time adjustment.

### 3. Modes of operation

006 The recording equipment shall possess four modes of operation:

- operational mode,
- control mode,
- calibration mode,
- company mode.

007 The recording equipment shall switch to the following mode of operation according to the valid tachograph cards inserted into the card interface devices:

Mode of operation		Driver slot				
		No card	Driver card	Control card	Workshop card	Company card
Co-driver slot	No card	Operational	Operational	Control	Calibration	Company
	Driver card	Operational	Operational	Control	Calibration	Company
	Control card	Control	Control	Control (*)	Operational	Operational
	Workshop card	Calibration	Calibration	Operational	Calibration (*)	Operational
	Company card	Company	Company	Operational	Operational	Company (*)

008 (\*) In these situations the recording equipment shall use only the tachograph card inserted in the driver slot.

- 009 The recording equipment shall ignore non-valid cards inserted, except displaying, printing or downloading data held on an expired card which shall be possible.
- 010 All functions listed in II.2. shall work in any mode of operation with the following exceptions:
- the calibration function is accessible in the calibration mode only,
  - the time adjustment function is limited when not in the calibration mode,
  - the driver manual entries functions are accessible in operational or calibration modes only,
  - the company locks management function is accessible in the company mode only,
  - the monitoring of control activities function is operational in the control mode only,
  - the downloading function is not accessible in the operational mode (except as provided for in Requirement 150).
- 011 The recording equipment can output any data to display, printer or external interfaces with the following exceptions:
- in the operational mode, any personal identification (surname and first name(s)) not corresponding to a tachograph card inserted shall be blanked and any card number not corresponding to a tachograph card inserted shall be partially blanked (every odd character — from left to right — shall be blanked),
  - in the company mode, driver related data (requirements 081, 084 and 087) can be output only for periods not locked by another company (as identified by the first 13 digits of the company card number),
  - when no card is inserted in the recording equipment, driver related data can be output only for the current and eight previous calendar days.

#### 4. Security

The system security aims at protecting the data memory in such a way as to prevent unauthorised access to and manipulation of the data and detecting any such attempts, protecting the integrity and authenticity of data exchanged between the motion sensor and the vehicle unit, protecting the integrity and authenticity of data exchanged between the recording equipment and the tachograph cards, and verifying the integrity and authenticity of data downloaded.

- 012 In order to achieve the system security, the recording equipment shall meet the security requirements specified in the motion sensor and vehicle unit generic security targets (Appendix 10).

### III. CONSTRUCTION AND FUNCTIONAL REQUIREMENTS FOR RECORDING EQUIPMENT

#### 1. Monitoring cards insertion and withdrawal

- 013 The recording equipment shall monitor the card interface devices to detect card insertions and withdrawals.
- 014 Upon card insertion the recording equipment shall detect whether the card inserted is a valid tachograph card and in such a case identify the card type.
- 015 The recording equipment shall be so designed that the tachograph cards are locked in position on their proper insertion into the card interface devices.
- 016 The release of tachograph cards may function only when the vehicle is stopped and after the relevant data have been stored on the cards. The release of the card shall require positive action by the user.

#### 2. Speed and distance measurement

- 017 This function shall continuously measure and be able to provide the odometer value corresponding to the total distance travelled by the vehicle.
- 018 This function shall continuously measure and be able to provide the speed of the vehicle.

019 The speed measurement function shall also provide the information whether the vehicle is moving or stopped. The vehicle shall be considered as moving as soon as the function detects more than 1 imp/sec for at least five seconds from the motion sensor, otherwise the vehicle shall be considered as stopped.

Devices displaying speed (speedometer) and total distance travelled (odometer) installed in any vehicle fitted with a recording equipment complying with the provisions of this Regulation, shall comply with the requirements relating to maximum tolerances laid down in this Annex (Chapters III(2)(1) and III(2)(2)).

### 2.1. *Measurement of distance travelled*

020 The distance travelled may be measured either:

- so as to cumulate both forward and reverse movements, or
- so as to include only forward movement.

021 The recording equipment shall measure distance from 0 to 9 999 999,9 km.

022 Distance measured shall be within the following tolerances (distances of at least 1 000 m):

- $\pm 1\%$  before installation,
- $\pm 2\%$  on installation and periodic inspection,
- $\pm 4\%$  in use.

023 Distance measured shall have a resolution better than or equal to 0,1 km.

### 2.2. *Measurement of speed*

024 The recording equipment shall measure speed from 0 to 220 km/h.

025 To ensure a maximum tolerance on speed displayed of  $\pm 6$  km/h in use, and taking into account:

- a  $\pm 2$  km/h tolerance for input variations (tyre variations, ...),
- a  $\pm 1$  km/h tolerance in measurements made during installation or periodic inspections,

the recording equipment shall, for speeds between 20 and 180 km/h, and for characteristic coefficients of the vehicle between 4 000 and 25 000 imp/km, measure the speed with a tolerance of  $\pm 1$  km/h (at constant speed).

Note: The resolution of data storage brings an additional tolerance of  $\pm 0,5$  km/h to speed stored by the recording equipment.

025a The speed shall be measured correctly within the normal tolerances within 2 seconds of the end of a speed change when the speed has changed at a rate up to 2 m/s<sup>2</sup>.

026 Speed measurement shall have a resolution better than or equal to 1 km/h.

## 3. *Time measurement*

027 The time measurement function shall measure permanently and digitally provide UTC date and time.

028 UTC date and time shall be used for dating throughout the recording equipment (recordings, printouts, data exchange, display, ...).

029 In order to visualise the local time, it shall be possible to change the offset of the time displayed, in half hour steps.

030 Time drift shall be within  $\pm 2$  seconds per day in type approval conditions.

031 Time measured shall have a resolution better than or equal to 1 second.

032 Time measurement shall not be affected by an external power supply cut-off of less than 12 months in type approval conditions.

#### 4. Monitoring driver activities

- 033 This function shall permanently and separately monitor the activities of one driver and one co-driver.
- 034 Driver activity shall be DRIVING, WORK, AVAILABILITY, or BREAK/REST.
- 035 It shall be possible for the driver and/or the co-driver to manually select WORK, AVAILABILITY, or BREAK/REST.
- 036 When the vehicle is moving, DRIVING shall be selected automatically for the driver and AVAILABILITY shall be selected automatically for the co-driver.
- 037 When the vehicle stops, WORK shall be selected automatically for the driver.
- 038 The first change of activity arising within 120 seconds of the automatic change to WORK due to the vehicle stop shall be assumed to have happened at the time of vehicle stop (therefore possibly cancelling the change to WORK).
- 039 This function shall output activity changes to the recording functions at a resolution of one minute.
- 040 Given a calendar minute, if any DRIVING activity has occurred within the minute, the whole minute shall be regarded as DRIVING.
- 041 Given a calendar minute, if any DRIVING activity has occurred within both the immediately preceding and the immediately succeeding minute, the whole minute shall be regarded as DRIVING.
- 042 Given a calendar minute that is not regarded as DRIVING according to previous requirements, the whole minute shall be regarded to be of the same type of activity as the longest continuous activity within the minute (or the latest of the equally longest).
- 043 This function shall also permanently monitor the continuous driving time and the cumulative break time of the driver.

#### 5. Monitoring driving status

- 044 This function shall permanently and automatically monitor the driving status.
- 045 The driving status CREW shall be selected when two valid driver cards are inserted in the equipment, the driving status SINGLE shall be selected in any other case.

#### 6. Drivers manual entries

##### 6.1. *Entry of places where daily work periods begin and/or end*

- 046 This function shall allow for the entry of places where the daily work periods begin and/or end for a driver and/or a co-driver.
- 047 Places are defined as the country and, in addition where applicable, the region.
- 048 At the time of a driver (or workshop) card withdrawal, the recording equipment shall prompt the (co-)driver to enter a "place where the daily work period ends".
- 049 The recording equipment shall allow this request to be disregarded.
- 050 It shall be possible to input places where daily work periods begin and/or end without card or at times other than card insertion or withdrawal.

##### 6.2. *Manual entry of driver activities*

- 050a Upon driver (or workshop) card insertion, and only at this time, the recording equipment shall:
- remind the cardholder the date and time of his last card withdrawal, and
  - ask the cardholder to identify if the current insertion of the card represents a continuation of the current daily work period.



The recording equipment shall allow the cardholder to disregard the question without answering, or to answer positively, or to answer negatively:

- in the case where the cardholder disregards the question, the recording equipment shall prompt the cardholder for a "place where the daily work period begins". The recording equipment shall allow this request to be disregarded. If a location is entered, then it shall be recorded, in the data memory and in the tachograph card, and related to the card insertion time,
- in the case of a negative or positive answer, the recording equipment shall invite the cardholder to enter activities manually, with their dates and times of beginning and end, among WORK, AVAILABILITY, or BREAK/REST only, strictly included within the period last card withdrawal — current insertion only, and without allowing such activities to overlap mutually. This shall be done in accordance with the following procedures:
  - in the case where the cardholder answers positively to the question, the recording equipment shall invite the cardholder to enter activities manually, in chronological order, for the period last card withdrawal — current insertion. The process shall end when the end time of a manually entered activity equals the card insertion time.
  - in the case where the cardholder answers negatively to the question, the recording equipment shall:
    - invite the card holder to enter manually activities in chronological order from the card withdrawal time up to the time of end of the related daily work period (or of the activities related to that vehicle in the case where the daily work period continues on a record sheet). The recording equipment shall therefore, before allowing the cardholder to enter manually each activity, invite the cardholder to identify if the time of end of the last recorded activity represents the end of a previous work period (see note below),

Notes: in the case where the cardholder fails to declare when the previous work period ended, and manually enters an activity of which end time equals the card insertion time, the recording equipment shall:

- assume that the daily work period ended at the start of the first REST (or remaining UNKNOWN) period after card withdrawal or at the time of card withdrawal if no rest period has been entered (and if no period remains UNKNOWN),
- assume that the start time (see below) equals the card insertion time,
- proceed through the steps below;
- then, if the time of end of the related work period is different from the time of card withdrawal, or if no place of end of daily work period had been entered at that time, prompt the cardholder to "confirm or enter the place where the daily work period ended" (the recording equipment shall allow this request to be disregarded). If a location is entered, it shall be recorded in the tachograph card only and only if different from the one entered at card withdrawal (if one was entered), and related to the time of end of the work period,
- then invite the cardholder to "enter a start time" of the current daily work period (or of the activities related to the current vehicle in the case where the card holder previously used a record sheet during this period), and prompt the cardholder for a "place where the daily work period begins" (the recording equipment shall allow this request to be disregarded). If a location is entered, it shall be recorded in the tachograph card and related to this start time. If this start time is equal to the card insertion time, the location shall also be recorded in the data memory,
- then, if this start time is different from the card insertion time, invite the cardholder to enter manually activities in chronological order from this start time up to the time of card insertion. The process shall end when the end time of a manually entered activity equals the card insertion time,
- the recording equipment shall then allow the card holder to modify any activity manually entered, until validation by selection of a specific command, and thereafter forbid any such modification,
- such answers to the initial question followed by no activity entries, shall be interpreted by the recording equipment as if the cardholder had disregarded the question.

During this whole process, the recording equipment shall wait for entries no longer than the following time-outs:

- if no interaction with the equipment's human machine interface is happening during one minute (with a visual, and possibly audible, warning after 30 seconds) or,
- if the card is withdrawn or another driver (or workshop) card is inserted or,
- as soon as the vehicle is moving,

in this case the recording equipment shall validate any entries already made.

### 6.3. *Entry of specific conditions*

050b The recording equipment shall allow the driver to enter, in real time, the following two specific conditions:

- "OUT OF SCOPE" (begin, end)
- "FERRY/TRAIN CROSSING"

A "FERRY/TRAIN CROSSING" may not occur if an "OUT OF SCOPE" condition is opened.

An opened "OUT OF SCOPE" condition must be automatically closed, by the recording equipment, if a driver card is inserted or withdrawn.

## 7. **Company locks management**

- 051 This function shall allow the management of the locks placed by a company to restrict data access in company mode to itself.
- 052 Company locks consist in a start date/time (lock-in) and an end date/time (lock-out) associated with the identification of the company as denoted by the company card number (at lock-in).
- 053 Locks may be turned "in" or "out" in real time only.
- 054 Locking-out shall only be possible for the company whose lock is "in" (as identified by the first 13 digits of the company card number), or,
- 055 locking-out shall be automatic if another company locks in.
- 055a In the case where a company locks in and where the previous lock was for the same company, then it will be assumed that the previous lock has not been turned "out" and is still "in".

## 8. **Monitoring control activities**

- 056 This function shall monitor DISPLAYING, PRINTING, VU and card DOWNLOADING activities carried while in control mode.
- 057 This function shall also monitor OVER SPEEDING CONTROL activities while in control mode. An over speeding control is deemed to have happened when, in control mode, the "over speeding" printout has been sent to the printer or to the display, or when "events and faults" data have been downloaded from the VU data memory.

## 9. **Detection of events and/or faults**

058 This function shall detect the following events and/or faults:

### 9.1. *Insertion of a non-valid card" event*

059 This event shall be triggered at the insertion of any non-valid card and/or when an inserted valid card expires.

9.2. **"Card conflict" event**

060 This event shall be triggered when any of the valid cards combination noted X in the following table arise:

Card conflict		Driver slot				
		No card	Driver card	Control card	Workshop card	Company card
Co-driver slot	No card					
	Driver card				X	
	Control card			X	X	X
	Workshop card		X	X	X	X
	Company card			X	X	X

9.3. **"Time overlap" event**

061 This event shall be triggered when the date/time of last withdrawal of a driver card, as read from the card, is later than the current date/time of the recording equipment in which the card is inserted.

9.4. **"Driving without an appropriate card" event**

062 This event shall be triggered for any tachograph cards combination noted X in the following table, when driver activity changes to DRIVING, or when there is a change of the mode of operation while driver activity is DRIVING:

Driving without an appropriate card		Driver slot				
		No (or non-valid) card	Driver card	Control card	Workshop card	Company card
Co-driver slot	No (or non-valid) card	X		X		X
	Driver card	X		X	X	X
	Control card	X	X	X	X	X
	Workshop card	X	X	X		X
	Company card	X	X	X	X	X

9.5. **"Card insertion while driving" event**

063 This event shall be triggered when a tachograph card is inserted in any slot, while driver activity is DRIVING.

9.6. **"Last card session not correctly closed" event**

064 This event shall be triggered when at card insertion the recording equipment detects that, despite the provisions laid down in paragraph III(1), the previous card session has not been correctly closed (the card has been withdrawn before all relevant data have been stored on the card). This event shall be triggered by driver and workshop cards only.

9.7. **"Over speeding" event**

065 This event shall be triggered for each over speeding.

### 9.8. "Power supply interruption" event

066 This event shall be triggered, while not in calibration mode, in case of any interruption exceeding 200 milliseconds of the power supply of the motion sensor and/or of the vehicle unit. The interruption threshold shall be defined by the manufacturer. The drop in power supply due to the starting of the engine of the vehicle shall not trigger this event.

### 9.9. "Motion data error" event

067 This event shall be triggered in case of interruption of the normal data flow between the motion sensor and the vehicle unit and/or in case of data integrity or data authentication error during data exchange between the motion sensor and the vehicle unit.

### 9.10. "Security breach attempt" event

068 This event shall be triggered for any other event affecting the security of the motion sensor and/or of the vehicle unit as specified within the generic security targets of these components, while not in calibration mode.

### 9.11. "Card" fault

069 This fault shall be triggered when a tachograph card failure occurs during operation.

### 9.12. "Recording equipment" fault

070 This fault shall be triggered for any of these failures, while not in calibration mode:

- VU internal fault,
- printer fault,
- display fault,
- downloading fault,
- sensor fault.

## 10. Built-in and self tests

071 The recording equipment shall self-detect faults through self tests and built-in-tests, according to the following table:

Sub-assembly to test	Self test	Built-in-test
Software		Integrity
Data memory	Access	Access, data integrity
Card interface devices	Access	Access
Keyboard		Manual check
Printer	(up to manufacturer)	Printout
Display		Visual check
Downloading (performed only during downloading)	Proper operation	
Sensor	Proper operation	Proper operation

## 11. Reading from data memory

072 The recording equipment shall be able to read any data stored in its data memory.

## 12. Recording and storing in the data memory

For the purpose of this paragraph,

- “365 days” is defined as 365 calendar days of average drivers activity in a vehicle. The average activity per day in a vehicle is defined as at least six drivers or co-drivers, six card insertion withdrawal cycles, and 256 activity changes. “365 days” therefore include at least 2 190 (co-)drivers, 2 190 card insertion withdrawal cycles, and 93 440 activity changes,
- times are recorded with a resolution of one minute, unless otherwise specified,
- odometer values are recorded with a resolution of one kilometre,
- speeds are recorded with a resolution of 1 km/h.

073 Data stored into the data memory shall not be affected by an external power supply cut-off of less than twelve months in type approval conditions.

074 The recording equipment shall be able to record and store implicitly or explicitly in its data memory the following:

### 12.1. Equipment identification data

#### 12.1.1. Vehicle unit identification data

075 The recording equipment shall be able to store in its data memory the following vehicle unit identification data:

- name of the manufacturer,
- address of the manufacturer,
- part number,
- serial number,
- software version number,
- software version installation date,
- year of equipment manufacture,
- approval number.

076 Vehicle unit identification data are recorded and stored once and for all by the vehicle unit manufacturer, except the software-related data and the approval number which may be changed in case of software upgrade.

#### 12.1.2. Motion sensor identification data

077 The motion sensor shall be able to store in its memory the following identification data:

- name of the manufacturer,
- part number,
- serial number,
- approval number,
- embedded security component identifier (e.g. internal chip/processor part number),
- operating system identifier (e.g. software version number).

078 Motion sensor identification data are recorded and stored once and for all in the motion sensor, by the motion sensor manufacturer.

079 The vehicle unit shall be able to record and store in its data memory the following currently paired motion sensor identification data:

- serial number,
- approval number,
- first pairing date.

#### 12.2. *Security elements*

080 The recording equipment shall be able to store the following security elements:

- European public key,
- Member State certificate,
- equipment certificate,
- equipment private key.

Recording equipment security elements are inserted in the equipment by the vehicle unit manufacturer.

#### 12.3. *Driver card insertion and withdrawal data*

081 For each insertion and withdrawal cycle of a driver or workshop card in the equipment, the recording equipment shall record and store in its data memory:

- the card holder's surname and first name(s) as stored in the card,
- the card's number, issuing Member State and expiry date as stored in the card,
- the insertion date and time,
- the vehicle odometer value at card insertion,
- the slot in which the card is inserted,
- the withdrawal date and time,
- the vehicle odometer value at card withdrawal,
- the following information about the previous vehicle used by the driver, as stored in the card:
  - VRN and registering Member State,
  - card withdrawal date and time,
- a flag indicating whether, at card insertion, the card holder has manually entered activities or not.

082 The data memory shall be able to hold these data for at least 365 days.

083 When storage capacity is exhausted, new data shall replace oldest data.

#### 12.4. *Driver activity data*

084 The recording equipment shall record and store in its data memory whenever there is a change of activity for the driver and/or the co-driver, and/or whenever there is a change of driving status, and/or whenever there is an insertion or withdrawal of a driver or workshop card:

- the driving status (CREW, SINGLE),
- the slot (DRIVER, CO-DRIVER),
- the card status in the relevant slot (INSERTED, NOT INSERTED) (see Note),
- the activity (DRIVING, AVAILABILITY, WORK, BREAK/REST),
- the date and time of the change.

Note: INSERTED means that a valid driver or workshop card is inserted in the slot. NOT INSERTED means the opposite, i.e. no valid driver or workshop card is inserted in the slot (e.g. a company card is inserted or no card is inserted).

Note: Activity data manually entered by a driver are not recorded in the data memory.

085 The data memory shall be able to hold driver activity data for at least 365 days.

086 When storage capacity is exhausted, new data shall replace oldest data.

#### 12.5. *Places where daily work periods start and/or end*

087 The recording equipment shall record and store in its data memory whenever a (co-)driver enters the place where a daily work period begins and/or ends:

- if applicable, the (co-)driver card number and card issuing Member State,
- the date and time of the entry (or the date/time related to the entry when the entry is made during the manual entry procedure),
- the type of entry (begin or end, condition of entry),
- the country and region entered,
- the vehicle odometer value.

088 The data memory shall be able to hold daily work periods start and/or end data for at least 365 days (with the assumption that one driver enters two records per day).

089 When storage capacity is exhausted, new data shall replace oldest data.

#### 12.6. *Odometer data*

090 The recording equipment shall record in its data memory the vehicle odometer value and the corresponding date at midnight every calendar day.

091 The data memory shall be able to store midnight odometer values for at least 365 calendar days.

092 When storage capacity is exhausted, new data shall replace oldest data.

#### 12.7. *Detailed speed data*

093 The recording equipment shall record and store in its data memory the instantaneous speed of the vehicle and the corresponding date and time at every second of at least the last 24 hours that the vehicle has been moving.

#### 12.8. *Events data*

For the purpose of this subparagraph, time shall be recorded with a resolution of one second.

094 The recording equipment shall record and store in its data memory the following data for each event detected according to the following storage rules:

Event	Storage rules	Data to be recorded per event
Card conflict	<ul style="list-style-type: none"> <li>— the 10 most recent events.</li> </ul>	<ul style="list-style-type: none"> <li>— date and time of beginning of event,</li> <li>— date and time of end of event,</li> <li>— cards' type, number and issuing Member State of the two cards creating the conflict.</li> </ul>
Driving without an appropriate card	<ul style="list-style-type: none"> <li>— the longest event for each of the 10 last days of occurrence,</li> <li>— the five longest events over the last 365 days.</li> </ul>	<ul style="list-style-type: none"> <li>— date and time of beginning of event,</li> <li>— date and time of end of event,</li> <li>— cards' type, number and issuing Member State of any card inserted at beginning and/or end of the event,</li> <li>— number of similar events that day.</li> </ul>
Card insertion while driving	<ul style="list-style-type: none"> <li>— the last event for each of the 10 last days of occurrence.</li> </ul>	<ul style="list-style-type: none"> <li>— date and time of the event,</li> <li>— card's type, number and issuing Member State,</li> <li>— number of similar events that day.</li> </ul>
Last card session not correctly closed	<ul style="list-style-type: none"> <li>— the 10 most recent events.</li> </ul>	<ul style="list-style-type: none"> <li>— date and time of card insertion,</li> <li>— card's type, number and issuing Member State,</li> <li>— last session data as read from the card:               <ul style="list-style-type: none"> <li>— date and time of card insertion,</li> <li>— VRN and Member State of registration.</li> </ul> </li> </ul>
Over speeding <sup>(1)</sup>	<ul style="list-style-type: none"> <li>— the most serious event for each of the 10 last days of occurrence (i.e. the one with the highest average speed),</li> <li>— the five most serious events over the last 365 days.</li> <li>— the first event having occurred after the last calibration.</li> </ul>	<ul style="list-style-type: none"> <li>— date and time of beginning of event,</li> <li>— date and time of end of event,</li> <li>— maximum speed measured during the event,</li> <li>— arithmetic average speed measured during the event,</li> <li>— card's type, number and issuing Member State of the driver (if applicable),</li> <li>— number of similar events that day.</li> </ul>



Event	Storage rules	Data to be recorded per event
Power supply interruption <sup>(2)</sup>	<ul style="list-style-type: none"> <li>— the longest event for each of the 10 last days of occurrence,</li> <li>— the five longest events over the last 365 days.</li> </ul>	<ul style="list-style-type: none"> <li>— date and time of beginning of event,</li> <li>— date and time of end of event,</li> <li>— cards' type, number and issuing Member State of any card inserted at beginning and/or end of the event,</li> <li>— number of similar events that day.</li> </ul>
Motion data error	<ul style="list-style-type: none"> <li>— the longest event for each of the 10 last days of occurrence,</li> <li>— the five longest events over the last 365 days.</li> </ul>	<ul style="list-style-type: none"> <li>— date and time of beginning of event,</li> <li>— date and time of end of event,</li> <li>— cards' type, number and issuing Member State of any card inserted at beginning and/or end of the event,</li> <li>— number of similar events that day.</li> </ul>
Security breach attempt	<ul style="list-style-type: none"> <li>— the 10 most recent events per type of event.</li> </ul>	<ul style="list-style-type: none"> <li>— date and time of beginning of event,</li> <li>— date and time of end of event (if relevant),</li> <li>— cards' type, number and issuing Member State of any card inserted at beginning and/or end of the event,</li> <li>— type of event.</li> </ul>

095

<sup>(1)</sup> The recording equipment shall also record and store in its data memory:

- the date and time of the last OVER SPEEDING CONTROL,
- the date and time of the first over speeding following this OVER SPEEDING CONTROL,
- the number of over speeding events since the last OVER SPEEDING CONTROL.

<sup>(2)</sup> These data may be recorded at power supply reconnection only, times may be known with an accuracy to the minute.

### 12.9. *Faults data*

For the purpose of this subparagraph, time shall be recorded with a resolution of one second.

096

The recording equipment shall attempt to record and store in its data memory the following data for each fault detected according to the following storage rules:

Fault	Storage rules	Data to be recorded per fault
Card fault	<ul style="list-style-type: none"> <li>— the 10 most recent driver card faults.</li> </ul>	<ul style="list-style-type: none"> <li>— date and time of beginning of fault,</li> <li>— date and time of end of fault,</li> <li>— card's type number and issuing Member State.</li> </ul>
Recording equipment faults	<ul style="list-style-type: none"> <li>— the 10 most recent faults for each type of fault,</li> <li>— the first fault after the last calibration.</li> </ul>	<ul style="list-style-type: none"> <li>— date and time of beginning of fault,</li> <li>— date and time of end of fault,</li> <li>— type of fault,</li> <li>— cards' type, number and issuing Member State of any card inserted at beginning and/or end of the fault.</li> </ul>

**12.10. Calibration data**

- 097 The recording equipment shall record and store in its data memory data relevant to:
- known calibration parameters at the moment of activation,
  - its very first calibration following its activation,
  - its first calibration in the current vehicle (as identified by its VIN),
  - the five most recent calibrations (If several calibrations happen within one calendar day, only the last one of the day shall be stored).
- 098 The following data shall be recorded for each of these calibrations:
- purpose of calibration (activation, first installation, installation, periodic inspection),
  - workshop name and address,
  - workshop card number, card issuing Member State and card expiry date,
  - vehicle identification,
  - parameters updated or confirmed: w, k, l, tyre size, speed limiting device setting, odometer (old and new values), date and time (old and new values).
- 099 The motion sensor shall record and store in its memory the following motion sensor installation data:
- first pairing with a VU (date, time, VU approval number, VU serial number),
  - last pairing with a VU (date, time, VU approval number, VU serial number).

**12.11. Time adjustment data**

- 100 The recording equipment shall record and store in its data memory data relevant to:
- the most recent time adjustment,
  - the five largest time adjustments, since last calibration,
- performed in calibration mode outside the frame of a regular calibration (definition (f)).
- 101 The following data shall be recorded for each of these time adjustments:
- date and time, old value,
  - date and time, new value,
  - workshop name and address,
  - workshop card number, card issuing Member State and card expiry date.

**12.12. Control activity data**

- 102 The recording equipment shall record and store in its data memory the following data relevant to the 20 most recent control activities:
- date and time of the control,
  - control card number and card issuing Member State,
  - type of the control (displaying and/or printing and/or VU downloading and/or card downloading).

103 In case of downloading, the dates of the oldest and of the most recent days downloaded shall also be recorded.

#### 12.13. *Company locks data*

104 The recording equipment shall record and store in its data memory the following data relevant to the 20 most recent company locks:

- lock-in date and time,
- lock-out date and time,
- company card number and card issuing Member State,
- company name and address.

#### 12.14. *Download activity data*

105 The recording equipment shall record and store in its data memory the following data relevant to the last data memory downloading to external media while in company or in calibration mode:

- date and time of downloading,
- company or workshop card number and card issuing Member State,
- company or workshop name.

#### 12.15. *Specific conditions data*

105a The recording equipment shall record in its data memory the following data relevant to specific conditions:

- date and time of the entry,
- type of specific condition.

105b The data memory shall be able to hold specific conditions data for at least 365 days (with the assumption that on average, one condition is opened and closed per day). When storage capacity is exhausted, new data shall replace oldest data.

### 13. *Reading from tachograph cards*

106 The recording equipment shall be able to read from tachograph cards, where applicable, the necessary data:

- to identify the card type, the card holder, the previously used vehicle, the date and time of the last card withdrawal and the activity selected at that time,
- to check that last card session was correctly closed,
- to compute the driver's continuous driving time, cumulative break time and cumulated driving times for the previous and the current week,
- to print requested printouts related to data recorded on a driver card,
- to download a driver card to external media.

107 In case of a reading error, the recording equipment shall try again, three times maximum, the same read command, and then if still unsuccessful, declare the card faulty and non-valid.

### 14. *Recording and storing on tachograph cards*

108 The recording equipment shall set the "card session data" in the driver or workshop card right after the card insertion.

- 109 The recording equipment shall update data stored on valid driver, workshop and/or control cards with all necessary data relevant to the period while the card is inserted and relevant to the card holder. Data stored on these cards are specified in Chapter IV.
- 109a The recording equipment shall update driver activity and location data (as specified in Chapter IV, paragraphs 5.2.5 and 5.2.6), stored on valid driver and/or workshop cards, with activity and location data manually entered by the cardholder.
- 110 Tachograph cards data update shall be such that, when needed and taking into account card actual storage capacity, most recent data replace oldest data.
- 111 In the case of a writing error, the recording equipment shall try again, three times maximum, the same write command, and then if still unsuccessful, declare the card faulty and non valid.
- 112 Before releasing a driver card, and after all relevant data have been stored on the card, the recording equipment shall reset the card session data.

### 15. **Displaying**

- 113 The display shall include at least 20 characters.
- 114 The minimum character size shall be 5 mm high and 3,5 mm wide.
- 114a The display shall support the Latin 1 and Greek character sets defined by ISO 8859 parts 1 and 7, as specified in Appendix 1 Chapter 4 "Character sets". The display may use simplified glyphs (e.g. accented characters may be displayed without accent, or lower case letters may be shown as upper case letters).
- 115 The display shall be provided with adequate non-dazzling lighting.
- 116 Indications shall be visible from outside the recording equipment.
- 117 The recording equipment shall be able to display:
- default data,
  - data related to warnings,
  - data related to menu access,
  - other data requested by a user.

Additional information may be displayed by the recording equipment, provided that it is clearly distinguishable from information required above.

- 118 The display of the recording equipment shall use the pictograms or pictogram combinations listed in Appendix 3. Additional pictograms or pictogram combinations may also be provided by the display, if clearly distinguishable from the aforementioned pictogram or pictogram combinations.
- 119 The display shall always be ON when the vehicle is moving.
- 120 The recording equipment may include a manual or automatic feature to turn the display OFF when the vehicle is not moving.

Displaying format is specified in Appendix 5.

#### 15.1. **Default display**

- 121 When no other information needs to be displayed, the recording equipment shall display, by default, the following:
- the local time (as a result of UTC time + offset as set by the driver),
  - the mode of operation,
  - the current activity of the driver and the current activity of the co-driver,

- information related to the driver:
  - if his current activity is DRIVING, his current continuous driving time and his current cumulative break time,
  - if his current activity is not DRIVING, the current duration of this activity (since it was selected) and his current cumulative break time,
- information related to the co-driver:
  - the current duration of his activity (since it was selected).

122 Display of data related to each driver shall be clear, plain and unambiguous. In the case where the information related to the driver and the co-driver cannot be displayed at the same time, the recording equipment shall display by default the information related to the driver and shall allow the user to display the information related to the co-driver.

123 In the case where the display width does not allow to display by default the mode of operation, the recording equipment shall briefly display the new mode of operation when it changes.

124 The recording equipment shall briefly display the card holder name at card insertion.

124a When an "OUT OF SCOPE" condition is opened, then the default display must show using the relevant pictogram that the condition is opened (It is acceptable that the driver's current activity may not be shown at the same time).

#### 15.2. **Warning display**

125 The recording equipment shall display warning information using primarily the pictograms of Appendix 3, completed where needed by an additional numerically coded information. A literal description of the warning may also be added in the driver's preferred language.

#### 15.3. **Menu access**

126 The recording equipment shall provide necessary commands through an appropriate menu structure.

#### 15.4. **Other displays**

127 It shall be possible to display selectively on request:

- the UTC date and time,
- the mode of operation (if not provided by default),
- the continuous driving time and cumulative break time of the driver,
- the continuous driving time and cumulative break time of the co-driver,
- the cumulated driving time of the driver for the previous and the current week,
- the cumulated driving time of the co-driver for the previous and the current week,
- the content of any of the six printouts under the same formats as the printouts themselves.

128 Printout content display shall be sequential, line by line. If the display width is less than 24 characters the user shall be provided with the complete information through an appropriate mean (several lines, scrolling, ...). Printout lines devoted to hand-written information may be omitted for display.

### 16. **Printing**

129 The recording equipment shall be able to print information from its data memory and/or from tachograph cards in accordance with the six following printouts:

- driver activities from card daily printout,
- driver activities from Vehicle Unit daily printout,

- events and faults from card printout,
- events and faults from Vehicle Unit printout,
- technical data printout,
- over speeding printout.

The detailed format and content of these printouts are specified in Appendix 4.

Additional data may be provided at the end of the printouts

Additional printouts may also be provided by the recording equipment, if clearly distinguishable from the six aforementioned printouts.

- 130 The "driver activities from card daily printout" and "events and faults from card printout" shall be available only when a driver card or a workshop card is inserted in the recording equipment. The recording equipment shall update data stored on the relevant card before starting printing.
- 131 In order to produce the "driver activities from card daily printout" or the "events and faults from card printout", the recording equipment shall:
- either automatically select the driver card or the workshop card if one only of these cards is inserted,
  - or provide a command to select the source card or select the card in the driver slot if two of these cards are inserted in the recording equipment.
- 132 The printer shall be able to print 24 characters per line.
- 133 The minimum character size shall be 2,1 mm high and 1,5 mm wide.
- 133a The printer shall support the Latin 1 and Greek character sets defined by ISO 8859 parts 1 and 7, as specified in Appendix 1 Chapter 4 "Character sets".
- 134 Printers shall be so designed as to produce these printouts with a degree of definition likely to avoid any ambiguity when they are read.
- 135 Printouts shall retain their dimensions and recordings under normal conditions of humidity (10 to 90 %) and temperature.
- 136 The paper for use by the recording equipment shall bear the relevant type approval mark and the indication of the type(s) of recording equipment with which it may be used. Printouts shall remain clearly legible and identifiable under normal conditions of storage, in terms of light intensity, humidity and temperature, for at least one year.
- 137 It shall also be possible to add handwritten notes, such as the driver's signature, to these documents.
- 138 The recording equipment shall manage "paper out" events while printing by, once paper has been re-loaded, restarting printing from printout beginning or by continuing printing and providing an unambiguous reference to previously printed part.

#### 17. Warnings

- 139 The recording equipment shall warn the driver when detecting any event and/or fault.
- 140 Warning of a power supply interruption event may be delayed until the power supply is reconnected.
- 141 The recording equipment shall warn the driver 15 minutes before and at the time of exceeding 4 h 30 min. continuous driving time.
- 142 Warnings shall be visual. Audible warnings may also be provided in addition to visual warnings.

- 143 Visual warnings shall be clearly recognisable by the user, shall be situated in the driver's field of vision and shall be clearly legible both by day and by night.
- 144 Visual warnings may be built into the recording equipment and/or remote from the recording equipment.
- 145 In the latter case it shall bear a "T" symbol and shall be amber or orange.
- 146 Warnings shall have a duration of at least 30 seconds, unless acknowledged by the user by hitting any key of the recording equipment. This first acknowledgement shall not erase warning cause display referred to in next paragraph.
- 147 Warning cause shall be displayed on the recording equipment and remain visible until acknowledged by the user using a specific key or command of the recording equipment.
- 148 Additional warnings may be provided, as long as they do not confuse drivers in relation to previously defined ones.

#### 18. Data downloading to external media

- 149 The recording equipment shall be able to download on request data from its data memory or from a driver card to external storage media via the calibration/downloading connector. The recording equipment shall update data stored on the relevant card before starting downloading.
- 150 In addition and as an optional feature, the recording equipment may, in any mode of operation, download data through another connector to a company authenticated through this channel. In such a case, company mode data access rights shall apply to this download.
- 151 Downloading shall not alter or delete any stored data.

The calibration/downloading connector electrical interface is specified in Appendix 6.

Downloading protocols are specified in Appendix 7.

#### 19. Output data to additional external devices

- 152 When the recording equipment does not include speed and/or odometer display functions, the recording equipment shall provide output signal(s) to allow for displaying the speed of the vehicle (speedometer) and/or the total distance travelled by the vehicle (odometer).
- 153 The vehicle unit shall also be able to output the following data using an appropriate dedicated serial link independent from an optional CAN bus connection (ISO 11898 Road vehicles — Interchange of digital information — Controller Area Network (CAN) for high speed communication), to allow their processing by other electronic units installed in the vehicle:

- current UTC date and time,
- speed of the vehicle,
- total distance travelled by the vehicle (odometer),
- currently selected driver and co-driver activity,
- information if any tachograph card is currently inserted in the driver slot and in the co-driver slot and (if applicable) information about the corresponding cards identification (card number and issuing Member State).

Other data may also be output in addition to this minimum list.

When the ignition of the vehicle is ON, these data shall be permanently broadcast. When the ignition of the vehicle is OFF, at least any change of driver or co-driver activity and/or any insertion or withdrawal of a tachograph card shall generate a corresponding data output. In the event that data output has been withheld whilst the ignition of the vehicle is OFF, that data shall be made available once the ignition of the vehicle is ON again.

## 20. Calibration

- 154 The calibration function shall allow:
- to automatically pair the motion sensor with the VU,
  - to digitally adapt the constant of the recording equipment (k) to the characteristic coefficient of the vehicle (w) (vehicles with two or more axle ratios shall be fitted with a switch device whereby these various ratios will automatically be brought into line with the ratio for which the equipment has been adapted to the vehicle),
  - to adjust (without limitation) the current time,
  - to adjust the current odometer value,
  - to update motion sensor identification data stored in the data memory,
  - to update or confirm other parameters known to the recording equipment: vehicle identification, w, l, tyre size and speed limiting device setting if applicable.
- 155 Pairing the motion sensor to the VU shall consist, at least, in:
- updating motion sensor installation data held by the motion sensor (as needed),
  - copying from the motion sensor to the VU data memory necessary motion sensor identification data.
- 156 The calibration function shall be able to input necessary data through the calibration/downloading connector in accordance with the calibration protocol defined in Appendix 8. The calibration function may also input necessary data through other connectors.

## 21. Time adjustment

- 157 The time adjustment function shall allow for adjusting the current time in amounts of one minute maximum at intervals of not less than seven days.
- 158 The time adjustment function shall allow for adjusting the current time without limitation, in calibration mode.

## 22. Performance characteristics

- 159 The Vehicle Unit shall be fully operational in the temperature range - 20 °C to 70 °C, and the motion sensor in the temperature range - 40 °C to 135 °C. Data memory content shall be preserved at temperatures down to - 40 °C.
- 160 The recording equipment shall be fully operational in the humidity range 10 % to 90 %.
- 161 The recording equipment shall be protected against over-voltage, inversion of its power supply polarity, and short circuits.
- 162 The recording equipment shall conform to Commission Directive 95/54/EC of 31 October 1995 <sup>(1)</sup> adapting to technical progress Council Directive 72/245/EEC <sup>(2)</sup>, related to electromagnetic compatibility, and shall be protected against electrostatic discharges and transients.

## 23. Materials

- 163 All the constituent parts of the recording equipment shall be made of materials of sufficient stability and mechanical strength and with stable electrical and magnetic characteristics.
- 164 For normal conditions of use, all the internal parts of the equipment shall be protected against damp and dust.
- 165 The Vehicle Unit shall meet the protection grade IP 40 and the motion sensor shall meet the protection grade IP 64, as per standard IEC 529.

<sup>(1)</sup> OJ L 266, 8.11.1995, p. 1.

<sup>(2)</sup> OJ L 152, 6.7.1972, p. 15.



- 166 The recording equipment shall conform to applicable technical specifications related to ergonomic design.
- 167 The recording equipment shall be protected against accidental damage.

#### 24. Markings

- 168 If the recording equipment displays the vehicle odometer value and speed, the following details shall appear on its display:
- near the figure indicating the distance, the unit of measurement of distance, indicated by the abbreviation “km”,
  - near the figure showing the speed, the entry “km/h”.
- The recording equipment may also be switched to display the speed in miles per hour, in which case the unit of measurement of speed shall be shown by the abbreviation “mph”.
- 169 A descriptive plaque shall be affixed to each separate component of the recording equipment and shall show the following details:
- name and address of the manufacturer of the equipment,
  - manufacturer's part number and year of manufacture of the equipment,
  - equipment serial number,
  - approval mark for the equipment type.
- 170 When physical space is not sufficient to show all abovementioned details, the descriptive plaque shall show at least: the manufacturer's name or logo, and the equipment's part number.

### IV. CONSTRUCTION AND FUNCTIONAL REQUIREMENTS FOR TACHOGRAPH CARDS

#### 1. Visible data

The front page will contain:

- 171 the words “Driver card” or “Control card” or “Workshop card” or “Company card” printed in large type in the official language or languages of the Member State issuing the card, according to the type of the card;
- 172 the same words in the other official languages of the Community, printed to form the background of the card:

ES	TARJETA DEL CONDUCTOR	TARJETA DE CONTROL	TARJETA DEL CENTRO DE ENSAYO	TARJETA DE LA EMPRESA
DK	FØRERKORT	KONTROLKORT	VÆRKSTEDSKORT	VIRKSOMHEDSKORT
DE	FAHRERKARTE	KONTROLLKARTE	WERKSTATTKARTE	UNTERNEHMENSKARTE
EL	KAPTA ΟΔΗΓΟΥ	KAPTA ΕΛΕΓΧΟΥ	KAPTA ΚΕΝΤΡΟΥ ΔΟΚΙΜΩΝ	KAPTA ΕΠΙΧΕΙΡΗΣΗΣ
EN	DRIVER CARD	CONTROL CARD	WORKSHOP CARD	COMPANY CARD
FR	CARTE DE CONDUCTEUR	CARTE DE CONTROLEUR	CARTE D'ATELIER	CARTE D'ENTREPRISE
GA	CÁRTA TIOMÁNAÍ	CÁRTA STIÚRTHA	CÁRTA CEARDLAINNE	CÁRTA COMHLACHTA
IT	CARTA DEL CONDUCENTE	CARTA DI CONTROLLO	CARTA DELL'OFFICINA	CARTA DELL'AZIENDA
NL	BESTUURDERS KAART	CONTROLEKAART	WERKPLAATSKAART	BEDRIJFSKAART
PT	CARTÃO DE CONDUTOR	CARTÃO DE CONTROLO	CARTÃO DO CENTRO DE ENSAIO	CARTÃO DE EMPRESA
FI	KULJETTAJA KORTTILLA	VALVONTA KORTTILLA	TESTAUSASEMA KORTTILLA	YRITYSKORTTILLA
SV	FÖRARKORT	KONTROLLKORT	VERKSTADSKORT	FÖRETAGSKORT

- 173 the name of the Member State issuing the card (optional);

174 the distinguishing sign of the Member State issuing the card, printed in negative in a blue rectangle and encircled by 12 yellow stars. The distinguishing signs shall be as follows:

B	Belgium
DK	Denmark
D	Germany
GR	Greece
E	Spain
F	France
IRL	Ireland
I	Italy
L	Luxembourg
NL	The Netherlands
A	Austria
P	Portugal
FIN	Finland
S	Sweden
UK	The United Kingdom;

175 information specific to the card issued, numbered as follows:







	Driver card	Control card	Company or workshop card
1.	Surname of the driver	Control body name	Company or workshop card
2.	First name(s) of the driver	Surname of the controller (if applicable)	Surname of card holder (if applicable)
3.	Birth date of the driver	First name(s) of the controller (if applicable)	First name(s) of card holder (if applicable)
4.(a)	Card start of validity date		
(b)	Card expiry date (if any)		
(c)	The name of the issuing authority (may be printed on page 2)		
(d)	A different number from the one under heading 5, for administrative purposes (optional)		
5.(a)	Driving licence number (at the date of issue of the driver card)		
5.(b)	Card number		
6.	Photograph of the driver	Photograph of the controller (optional)	—
7.	Signature of the driver	Signature of the holder (optional)	
8.	Normal place of residence, or postal address of the holder (optional)	Postal address of control body	Postal address of company or workshop

176 dates shall be written using a "dd/mm/yyyy" or "dd.mm.yyyy" format (day, month, year);

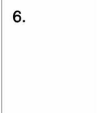
the reverse page will contain:

177 an explanation of the numbered items which appear on the front page of the card;

178 with the specific written agreement of the holder, information which is not related to the administration of the card may also be added, such addition will not alter in any way the use of the model as a tachograph card.

COMMUNITY MODEL TACHOGRAPH CARDS	
FRONT	REVERSE
<p><b>DRIVER CARD</b></p> <p>1.  MS</p> <p>2.</p> <p>3.</p> <p>4a.  6.</p> <p>4c.</p> <p>(4d.)</p> <p>5a.</p> <p>5b.</p> <p>7.</p> <p>(8.)</p> <p><b>MEMBER STATE</b></p> <p>TARJETA DEL CONDUCTOR</p> <p>FØRERKORT</p> <p>FAHRERKARTE</p> <p>4b. KAPTA O ΔΗΤΟΥ</p> <p>DRIVER CARD</p> <p>CARTE DE CONDUCTEUR</p> <p>CÁRTA TIOMÁNAÍ</p> <p>CARTA DEL CONDUCENTE</p> <p>BESTUURDESKAART</p> <p>CARTÃO DE CONDUTOR</p> <p>KULJETTAJAKORTILLA</p> <p>FÖRARKORT</p>	<p>1. Surname 2. First name(s) 3. Birth date</p> <p>4a. Date of start of validity of card</p> <p>4b. Administrative expiry date of card</p> <p>4c. Issuing authority</p> <p>(4d.) No for national administrative purposes</p> <p>5a. Driving license number 5b. Card number</p> <p>6. Photograph</p> <p>7. Signature (8.) Address</p> <p>Please return to:</p> <p><b>NAME OF AUTHORITY AND ADDRESS</b></p>
<p><b>CONTROL CARD</b></p> <p>1.  MS</p> <p>(2.)</p> <p>(3.)</p> <p>4a.  (6.)</p> <p>4c.</p> <p>(4d.)</p> <p>5b.</p> <p>(7.)</p> <p>8.</p> <p><b>MEMBER STATE</b></p> <p>TARJETA DE CONTROL</p> <p>KONTROLKORT</p> <p>KONTROLLKARTE</p> <p>(4b.) KAPTA ΕΛΕΓΧΟΥ</p> <p>CONTROL CARD</p> <p>CARTE DE CONTROLLEUR</p> <p>CÁRTA STIÜRTHA</p> <p>CARTA DI CONTROLLO</p> <p>CONTROLEKAART</p> <p>CARTÃO DE CONTROLLO</p> <p>VALVONTAKORTILLA</p> <p>KONTROLLKORT</p>	<p>1. Control Body (2.) Surname (3.) First name(s)</p> <p>4a. Date of start of validity of card</p> <p>(4b.) Administrative expiry date of card</p> <p>4c. Issuing authority</p> <p>(4d.) No for national administrative purposes</p> <p>5b. Card number</p> <p>(6.) Photograph</p> <p>(7.) Signature 8. Address</p> <p>Please return to:</p> <p><b>NAME OF AUTHORITY AND ADDRESS</b></p>
<p><b>WORKSHOP CARD</b></p> <p>1.  MS</p> <p>(2.)</p> <p>(3.)</p> <p>4a.  (6.)</p> <p>4c.</p> <p>(4d.)</p> <p>5b.</p> <p>(7.)</p> <p>8.</p> <p><b>MEMBER STATE</b></p> <p>TARJETA DEL CENTRO DE ENSAIO</p> <p>VÆRKSTEDSKORT</p> <p>WERKSTATTKARTE</p> <p>4b. KAPTA ΚΕΝΤΡΟΥ ΔΟΚΙΜΩΝ</p> <p>WORKSHOP CARD</p> <p>CARTE D'ATELIER</p> <p>CÁRTA CEARDLAINNE</p> <p>CARTA DELL'OFFICINA</p> <p>WERKPLAATSKAART</p> <p>CARTÃO DO CENTRO DE ENSAIO</p> <p>TESTAUSASEMAKORTILLA</p> <p>VERKSTADSKORT</p>	<p>1. Workshop Name (2.) Surname (3.) First name(s)</p> <p>4a. Date of start of validity of card</p> <p>4b. Administrative expiry date of card</p> <p>4c. Issuing authority</p> <p>(4d.) No for national administrative purposes</p> <p>5b. Card number</p> <p>(7.) Signature 8. Address</p> <p>Please return to:</p> <p><b>NAME OF AUTHORITY AND ADDRESS</b></p>
<p><b>COMPANY CARD</b></p> <p>1.  MS</p> <p>(2.)</p> <p>(3.)</p> <p>4a.  (6.)</p> <p>4c.</p> <p>(4d.)</p> <p>5b.</p> <p>(7.)</p> <p>8.</p> <p><b>MEMBER STATE</b></p> <p>TARJETA DE LA EMPRESA</p> <p>VIRKSOMHEDSKORT</p> <p>UNTERNEHMENSKARTE</p> <p>4b. KAPTA ΕΠΙΧΕΙΡΗΣΗΣ</p> <p>COMPANY CARD</p> <p>CARTE D'ENTREPRISE</p> <p>CÁRTA COMHLACHTA</p> <p>CARTA DELL'AZIENDA</p> <p>BEDRIJFSKAART</p> <p>CARTÃO DE EMPRESA</p> <p>YRITYSKORTILLA</p> <p>FÖRETAGSKORT</p>	<p>1. Company Name (2.) Surname (3.) First name(s)</p> <p>4a. Date of start of validity of card</p> <p>4b. Administrative expiry date of card</p> <p>4c. Issuing authority</p> <p>(4d.) No for national administrative purposes</p> <p>5b. Card number</p> <p>(7.) Signature 8. Address</p> <p>Please return to:</p> <p><b>NAME OF AUTHORITY AND ADDRESS</b></p>

179 Tachograph cards shall be printed with the following background predominant colours:

- driver card: white,
- control card: blue,
- workshop card: red,
- company card: yellow.

180 Tachograph cards shall bear at least the following features for protection of the card body against counterfeiting and tampering:

- a security design background with fine guilloche patterns and rainbow printing,
- in the area of the photograph, the security design background and the photograph shall overlap,
- at least one two-coloured microprint line.

- 181 After consulting the Commission, Member States may add colours or markings, such as national symbols and security features, without prejudice to the other provisions of this Annex.

## 2. Security

The system security aims at protecting integrity and authenticity of data exchanged between the cards and the recording equipment, protecting the integrity and authenticity of data downloaded from the cards, allowing certain write operations onto the cards to recording equipment only, ruling out any possibility of falsification of data stored in the cards, preventing tampering and detecting any attempt of that kind.

- 182 In order to achieve the system security, the tachograph cards shall meet the security requirements defined in the tachograph cards generic security target (Appendix 10).

- 183 Tachograph cards shall be readable by other equipment such as personal computers.

## 3. Standards

- 184 The tachograph cards shall comply with the following standards:

- ISO/IEC 7810 Identification cards — Physical characteristics,
- ISO/IEC 7816 Identification cards — Integrated circuits with contacts:
  - Part 1: Physical characteristics,
  - Part 2: Dimensions and location of the contacts,
  - Part 3: Electronic signals and transmission protocols,
  - Part 4: Inter-industry commands for interchange,
  - Part 8: Security related inter-industry commands,
- ISO/IEC 10373 Identification cards — Test methods.

## 4. Environmental and electrical specifications

- 185 The tachograph cards shall be capable of operating correctly in all the climatic conditions normally encountered in Community territory and at least in the temperature range  $-25^{\circ}\text{C}$  to  $+70^{\circ}\text{C}$  with occasional peaks of up to  $+85^{\circ}\text{C}$ , "occasional" meaning not more than 4 hours each time and not over 100 times during the lifetime of the card.

- 186 The tachograph cards shall be capable of operating correctly in the humidity range 10 % to 90 %.

- 187 The tachograph cards shall be capable of operating correctly for a five-year period if used within the environmental and electrical specifications.

- 188 During operation, the tachograph cards shall conform to Commission Directive 95/54/EC of 31 October 1995 <sup>(1)</sup>, related to electromagnetic compatibility, and shall be protected against electrostatic discharges.

## 5. Data storage

For the purpose of this paragraph,

- times are recorded with a resolution of one minute, unless otherwise specified,
- odometer values are recorded with a resolution of one kilometre,
- speeds are recorded with a resolution of 1 km/h.

The tachograph cards functions, commands and logical structures, fulfilling data storage requirements are specified in Appendix 2.

<sup>(1)</sup> OJ L 266, 8.11.1995, p. 1.

189 This paragraph specifies minimum storage capacity for the various application data files. The tachograph cards shall be able to indicate to the recording equipment the actual storage capacity of these data files.

Any additional data that may be stored on tachograph cards, related to other applications eventually borne by the card, shall be stored in accordance with Directive 95/46/EC of 24 October 1995 on the protection of individuals with regard to the processing of personal data and on the free movement of such data <sup>(1)</sup>.

#### 5.1. *Card identification and security data*

##### 5.1.1. *Application identification*

190 The tachograph cards shall be able to store the following application identification data:

- tachograph application identification,
- type of tachograph card identification.

##### 5.1.2. *Chip identification*

191 The tachograph cards shall be able to store the following integrated circuit (IC) identification data:

- IC serial number,
- IC manufacturing references.

##### 5.1.3. *IC card identification*

192 The tachograph cards shall be able to store the following smart card identification data:

- card serial number (including manufacturing references),
- card type approval number,
- card personaliser identification (ID),
- embedder ID,
- IC identifier.

##### 5.1.4. *Security elements*

193 The tachograph cards shall be able to store the following security elements data:

- European public key,
- Member State certificate,
- card certificate,
- card private key.

#### 5.2. *Driver card*

##### 5.2.1. *Card identification*

194 The driver card shall be able to store the following card identification data:

- card number,
- issuing Member State, issuing authority name, issue date,
- card beginning of validity date, card expiry date.

<sup>(1)</sup> OJ L 281, 23.11.1995, p. 31.

#### 5.2.2. Card holder identification

195 The driver card shall be able to store the following card holder identification data:

- surname of the holder,
- first name(s) of the holder,
- date of birth,
- preferred language.

#### 5.2.3. Driving licence information

196 The driver card shall be able to store the following driving licence data:

- issuing Member State, issuing authority name,
- driving licence number (at the date of the issue of the card).

#### 5.2.4. Vehicles used data

197 The driver card shall be able to store, for each calendar day where the card has been used, and for each period of use of a given vehicle that day (a period of use includes all consecutive insertion/withdrawal cycle of the card in the vehicle, as seen from the card point of view), the following data:

- date and time of first use of the vehicle (i.e. first card insertion for this period of use of the vehicle, or 00.00 if the period of use is on-going at that time),
- vehicle odometer value at that time,
- date and time of last use of the vehicle, (i.e. last card withdrawal for this period of use of the vehicle, or 23.59 if the period of use is on-going at that time),
- vehicle odometer value at that time,
- VRN and registering Member State of the vehicle.

198 The driver card shall be able to store at least 84 such records.

#### 5.2.5. Driver activity data

199 The driver card shall be able to store, for each calendar day where the card has been used or for which the driver has entered activities manually, the following data:

- the date,
- a daily presence counter (increased by one for each of these calendar days),
- the total distance travelled by the driver during this day,
- a driver status at 00.00,
- whenever the driver has changed of activity, and/or has changed of driving status, and/or has inserted or withdrawn his card:
  - the driving status (CREW, SINGLE),
  - the slot (DRIVER, CO-DRIVER),
  - the card status (INSERTED, NOT INSERTED),
  - the activity (DRIVING, AVAILABILITY, WORK, BREAK/REST),
  - the time of the change.

200 The driver card memory shall be able to hold driver activity data for at least 28 days (the average activity of a driver is defined as 93 activity changes per day).

201 The data listed under requirements 197 and 199 shall be stored in a way allowing the retrieval of activities in the order of their occurrence, even in case of a time overlap situation.

5.2.6. *Places where daily work periods start and/or end*

202 The driver card shall be able to store the following data related to places where daily work periods begin and/or end, entered by the driver:

- the date and time of the entry (or the date/time related to the entry if the entry is made during the manual entry procedure),
- the type of entry (begin or end, condition of entry),
- the country and region entered,
- the vehicle odometer value.

203 The driver card memory shall be able to hold at least 42 pairs of such records.

5.2.7. *Events data*

For the purpose of this subparagraph, time shall be stored with a resolution of one second.

204 The driver card shall be able to store data related to the following events detected by the recording equipment while the card was inserted:

- time overlap (where this card is the cause of the event),
- card insertion while driving (where this card is the subject of the event),
- last card session not correctly closed (where this card is the subject of the event),
- power supply interruption,
- motion data error,
- security breach attempts.

205 The driver card shall be able to store the following data for these events:

- event code,
- date and time of beginning of the event (or of card insertion if the event was on-going at that time),
- date and time of end of the event (or of card withdrawal if the event was on-going at that time),
- VRN and registering Member State of vehicle in which the event happened.

Note: For the "time overlap" event:

- date and time of beginning of the event shall correspond to the date and time of the card withdrawal from the previous vehicle,
- date and time of end of the event shall correspond to the date and time of card insertion in current vehicle,
- vehicle data shall correspond to the current vehicle raising the event.

Note: For the "last card session not correctly closed" event:

- date and time of beginning of event shall correspond to the card insertion date and time of the session not correctly closed,
- date and time of end of event shall correspond to the card insertion date and time of the session during which the event was detected (current session),
- vehicle data shall correspond to the vehicle in which the session was not correctly closed.

206 The driver card shall be able to store data for the six most recent events of each type (i.e. 36 events).

5.2.8. *Faults data*

For the purpose of this subparagraph, time shall be recorded with a resolution of one second.

207 The driver card shall be able to store data related to the following faults detected by the recording equipment while the card was inserted:

- card fault (where this card is the subject of the event),
- recording equipment fault.

208 The driver card shall be able to store the following data for these faults:

- fault code,
- date and time of beginning of the fault (or of card insertion if the fault was on-going at that time),
- date and time of end of the fault (or of card withdrawal if the fault was on-going at that time),
- VRN and registering Member State of vehicle in which the fault happened.

209 The driver card shall be able to store data for the twelve most recent faults of each type (i.e. 24 faults).

5.2.9. *Control activity data*

210 The driver card shall be able to store the following data related to control activities:

- date and time of the control,
- control card number and card issuing Member State,
- type of the control (displaying and/or printing and/or VU downloading and/or card downloading (see note)),
- period downloaded, in case of downloading,
- VRN and registering Member State of the vehicle in which the control happened.

Note: security requirements imply that card downloading will only be recorded if performed through a recording equipment.

211 The driver card shall be able to hold one such record.

5.2.10. *Card session data*

212 The driver card shall be able to store data related to the vehicle which opened its current session:

- date and time the session was opened (i.e. card insertion) with a resolution of one second,
- VRN and registering Member State.

5.2.11. *Specific conditions data*

212a The driver card shall be able to store the following data related to specific conditions entered while the card was inserted (whatever the slot):

- date and time of the entry,
- type of specific condition.



212b The driver card shall be able to hold 56 such records.

### 5.3. **Workshop card**

#### 5.3.1. *Security elements*

213 The workshop card shall be able to store a personal identification number (PIN code).

214 The workshop card shall be able to store the cryptographic keys needed for pairing motion sensors to vehicle units.

#### 5.3.2. *Card identification*

215 The workshop card shall be able to store the following card identification data:

- card number,
- issuing Member State, issuing authority name, issue date,
- card beginning of validity date, card expiry date.

#### 5.3.3. *Card holder identification*

216 The workshop card shall be able to store the following card holder identification data:

- workshop name,
- workshop address,
- surname of the holder,
- first name(s) of the holder,
- preferred language.

#### 5.3.4. *Vehicles used data*

217 The workshop card shall be able to store vehicles used data records in the same manner as a driver card.

218 The workshop card shall be able to store at least 4 such records.

#### 5.3.5. *Driver activity data*

219 The workshop card shall be able to store driver activity data in the same manner as a driver card.

220 The workshop card shall be able to hold driver activity data for at least one day of average driver activity.

#### 5.3.6. *Daily work periods start and/or end data*

221 The workshop card shall be able to store daily works period start and/or end data records in the same manner as a driver card.

222 The workshop card shall be able to hold at least three pairs of such records.

#### 5.3.7. *Events and faults data*

223 The workshop card shall be able to store events and faults data records in the same manner as a driver card.

224 The workshop card shall be able to store data for the three most recent events of each type (i.e. 18 events) and the six most recent faults of each type (i.e. 12 faults).

#### 5.3.8. *Control activity data*

225 The workshop card shall be able to store a control activity data record in the same manner as a driver card.

#### 5.3.9. Calibration and time adjustment data

- 226 The workshop card shall be able to hold records of calibrations and/or time adjustments performed while the card is inserted in a recording equipment.
- 227 Each calibration record shall be able to hold the following data:
- purpose of calibration (first installation, installation, periodic inspection),
  - vehicle identification,
  - parameters updated or confirmed (w, k, l, tyre size, speed limiting device setting, odometer (new and old values), date and time (new and old values),
  - recording equipment identification (VU part number, VU serial number, motion sensor serial number).
- 228 The workshop card shall be able to store at least 88 such records.
- 229 The workshop card shall hold a counter indicating the total number of calibrations performed with the card.
- 230 The workshop card shall hold a counter indicating the number of calibrations performed since its last download.

#### 5.3.10. Specific conditions data

- 230a The workshop card shall be able to store data relevant to specific conditions in the same manner as the driver card. The workshop card shall be able to store two such records.

### 5.4. Control card

#### 5.4.1. Card identification

- 231 The control card shall be able to store the following card identification data:
- card number,
  - issuing Member State, issuing authority name, issue date,
  - card beginning of validity date, card expiry date (if any).

#### 5.4.2. Card holder identification

- 232 The control card shall be able to store the following card holder identification data:
- control body name,
  - control body address,
  - surname of the holder,
  - first name(s) of the holder,
  - preferred language.

#### 5.4.3. Control activity data

- 233 The control card shall be able to store the following control activity data:
- date and time of the control,
  - type of the control (displaying and/or printing and/or VU downloading and/or card downloading),

- period downloaded (if any),
- VRN and Member State registering authority of the controlled vehicle,
- card number and card issuing Member State of the driver card controlled.

234 The control card shall be able to hold at least 230 such records.

#### 5.5. *Company card*

##### 5.5.1. *Card identification*

235 The company card shall be able to store the following card identification data:

- card number,
- issuing Member State, issuing authority name, issue date,
- card beginning of validity date, card expiry date (if any).

##### 5.5.2. *Card holder identification*

236 The company card shall be able to store the following card holder identification data:

- company name,
- company address.

##### 5.5.3. *Company activity data*

237 The company card shall be able to store the following company activity data:

- date and time of the activity,
- type of the activity (VU locking in and/or out, and/or VU downloading and/or card downloading),
- period downloaded (if any),
- VRN and Member State registering authority of vehicle,
- card number and card issuing Member State (in case of card downloading).

238 The company card shall be able to hold at least 230 such records.

## V. INSTALLATION OF RECORDING EQUIPMENT

### 1. **Installation**

239 New recording equipment shall be delivered non-activated to fitters or vehicle manufacturers, with all calibration parameters, as listed in Chapter III(20), set to appropriate and valid default values. Where no particular value is appropriate, literal parameters shall be set to strings of "?" and numeric parameters shall be set to "0".

240 Before its activation, the recording equipment shall give access to the calibration function even if not in calibration mode.

241 Before its activation, the recording equipment shall neither record nor store data referred by points III.12.3. to III.12.9. and III.12.12 to III.12.14. inclusive.

242 During installation, vehicle manufacturers shall pre-set all known parameters.

- 243 Vehicle manufacturers or fitters shall activate the installed recording equipment before the vehicle leaves the premises where the installation took place.
- 244 The activation of the recording equipment shall be triggered automatically by the first insertion of a workshop card in either of its card interface devices.
- 245 Specific pairing operations required between the motion sensor and the vehicle unit, if any, shall take place automatically before or during activation.
- 246 After its activation, the recording equipment shall fully enforce functions and data access rights.
- 247 The recording and storing functions of the recording equipment shall be fully operational after its activation.
- 248 Installation shall be followed by a calibration. The first calibration will include entry of VRN and will take place within 2 weeks of this installation or of VRN allocation whichever comes last.
- 248a The recording equipment must be positioned in the vehicle in such a way as to allow the driver to access the necessary functions from his seat.

## 2. Installation plaque

- 249 After the recording equipment has been checked on installation, an installation plaque which is clearly visible and easily accessible shall be affixed on, in or beside the recording equipment. After every inspection by an approved fitter or workshop, a new plaque shall be affixed in place of the previous one.
- 250 The plaque shall bear at least the following details:
- name, address or trade name of the approved fitter or workshop,
  - characteristic coefficient of the vehicle, in the form "w = ... imp/km",
  - constant of the recording equipment, in the form "k = ... imp/km",
  - effective circumference of the wheel tyres in the form "l = ... mm",
  - tyre size,
  - the date on which the characteristic coefficient of the vehicle was determined and the effective circumference of the wheel tyres measured,
  - the vehicle identification number.

## 3. Sealing

- 251 The following part shall be sealed:
- any connection which, if disconnected, would cause undetectable alterations to be made or undetectable data loss,
  - the installation plaque, unless it is attached in such a way that it cannot be removed without the markings thereon being destroyed.
- 252 The seals mentioned above may be removed:
- in case of emergency,
  - to install, to adjust or to repair a speed limitation device or any other device contributing to road safety, provided that the recording equipment continues to function reliably and correctly and is resealed by an approved fitter or workshop (in accordance with Chapter VI) immediately after fitting the speed limitation device or any other device contributing to road safety or within seven days in other cases.

- 253 On each occasion that these seals are broken a written statement giving the reasons for such action shall be prepared and made available to the competent authority.

## VI. CHECKS, INSPECTIONS AND REPAIRS

Requirements on the circumstances in which seals may be removed, as referred to in Article 12.5 of Regulation (EEC) No 3821/85 as last amended by Regulation (EC) No 2135/98, are defined in Chapter V(3) of this annex.

### 1. Approval of fitters or workshops

The Member States will approve, regularly control and certify the bodies to carry out:

- installations,
- checks,
- inspections,
- repairs.

In the framework of Article 12(1) of this Regulation, workshop cards will be issued only to fitters and/or workshops approved for the activation and/or the calibration of recording equipment in conformity with this annex and, unless duly justified:

- who are not eligible for a company card,
- and whose other professional activities do not present a potential compromise of the overall security of the system as defined in Appendix 10.

### 2. Check of new or repaired instruments

- 254 Every individual device, whether new or repaired, shall be checked in respect of its proper operation and the accuracy of its reading and recordings, within the limits laid down in Chapter III.2.1. and III.2.2 by means of sealing in accordance with Chapter V.3. and calibration.

### 3. Installation inspection

- 255 When being fitted to a vehicle, the whole installation (including the recording equipment) shall comply with the provisions relating to maximum tolerances laid down in Chapter III.2.1 and III.2.2.

### 4. Periodic inspections

- 256 Periodic inspections of the equipment fitted to the vehicles shall take place after any repair of the equipment, or after any alteration of the characteristic coefficient of the vehicle or of the effective circumference of the tyres, or after equipment UTC time is wrong by more than 20 minutes, or when the VRN has changed, and at least once within two years (24 months) of the last inspection.

- 257 These inspections shall include the following checks:

- that the recording equipment is working properly, including the data storage in tachograph cards function,
- that compliance with the provisions of Chapter III.2.1 and III.2.2 on the maximum tolerances on installation is ensured,
- that the recording equipment carries the type approval mark,
- that the installation plaque is affixed,
- that the seals on the equipment and on the other parts of the installation are intact,
- the tyre size and the actual circumference of the wheel tyres.

258 These inspections shall include a calibration.

#### 5. Measurement of errors

259 The measurement of errors on installation and during use shall be carried out under the following conditions, which are to be regarded as constituting standard test conditions:

- vehicle unladen, in normal running order,
- tyre pressures in accordance with the manufacturer's instructions,
- tyre wear, within the limits allowed by national law,
- vehicle movement:
  - the vehicle shall advance under its own engine power in a straight line on level ground and at a speed of  $50 \pm 5$  km/h. The measuring distance shall be at least 1 000 m,
- provided that it is of comparable accuracy, alternative methods, such as a suitable test bench, may also be used for the test.

#### 6. Repairs

260 Workshops shall be able to download data from the recording equipment to give the data back to the appropriate transport company.

261 Approved workshops shall issue to transport companies a certificate of data un-downloadability where the malfunction of the recording equipment prevents previously recorded data to be downloaded, even after repair by this workshop. The workshops will keep a copy of each issued certificate for at least one year.

### VII. CARD ISSUING

The card issuing processes set-up by the Member States shall conform to the following:

- 262 The card number of the first issue of a tachograph card to an applicant shall have a consecutive index (if applicable) and a replacement index and a renewal index set to "0".
- 263 The card numbers of all non-personal tachograph cards issued to a single control body or a single workshop or a single transport company shall have the same first 13 digits, and shall all have a different consecutive index.
- 264 A tachograph card issued in replacement of an existing tachograph card shall have the same card number as the replaced one except the replacement index which shall be raised by "1" (in the order 0, ..., 9, A, ..., Z).
- 265 A tachograph card issued in replacement of an existing tachograph card shall have the same card expiry date as the replaced one.
- 266 A tachograph card issued in renewal of an existing tachograph card shall have the same card number as the renewed one except the replacement index which shall be reset to "0" and the renewal index which shall be raised by "1" (in the order 0, ..., 9, A, ..., Z).
- 267 The exchange of an existing tachograph card, in order to modify administrative data, shall follow the rules of the renewal if within the same Member State, or the rules of a first issue if performed by another Member State.
- 268 The "card holder surname" for non-personal workshop or control cards shall be filled with workshop or control body name.

### VIII. TYPE APPROVAL OF RECORDING EQUIPMENT AND TACHOGRAPH CARDS

#### 1. General points

For the purpose of this chapter, the words "recording equipment" mean "recording equipment or its components". No type approval is required for the cable(s) linking the motion sensor to the VU. The paper, for use by the recording equipment, shall be considered as a component of the recording equipment.

- 269 Recording equipment shall be submitted for approval complete with any integrated additional devices.
- 270 Type approval of recording equipment and of tachograph cards shall include security related tests, functional tests and interoperability tests. Positive results to each of these tests are stated by an appropriate certificate.
- 271 Member States type approval authorities will not grant a type approval certificate in accordance with Article 5 of this Regulation, as long as they do not hold:
- a security certificate,
  - a functional certificate,
  - and an interoperability certificate,
- for the recording equipment or the tachograph card, subject of the request for type approval.
- 272 Any modification in software or hardware of the equipment or in the nature of materials used for its manufacture shall, before being used, be notified to the authority which granted type-approval for the equipment. This authority shall confirm to the manufacturer the extension of the type approval, or may require an update or a confirmation of the relevant functional, security and/or interoperability certificates.
- 273 Procedures to upgrade *in situ* recording equipment software shall be approved by the authority which granted type approval for the recording equipment. Software upgrade must not alter nor delete any driver activity data stored in the recording equipment. Software may be upgraded only under the responsibility of the equipment manufacturer.

## 2. Security certificate

- 274 The security certificate is delivered in accordance with the provisions of Appendix 10 to this Annex.

## 3. Functional certificate

- 275 Each candidate for type approval shall provide the Member State's type approval authority with all the material and documentation that the authority deems necessary.
- 276 A functional certificate shall be delivered to the manufacturer only after all functional tests specified in Appendix 9, at least, have been successfully passed.
- 277 The type approval authority delivers the functional certificate. This certificate shall indicate, in addition to the name of its beneficiary and the identification of the model, a detailed list of the tests performed and the results obtained.

## 4. Interoperability certificate

- 278 Interoperability tests are carried out by a single laboratory under the authority and responsibility of the European Commission.
- 279 The laboratory shall register interoperability test requests introduced by manufacturers in the chronological order of their arrival.
- 280 Requests will be officially registered only when the laboratory is in possession of:
- the entire set of material and documents necessary for such interoperability tests,
  - the corresponding security certificate,
  - the corresponding functional certificate,

The date of the registration of the request shall be notified to the manufacturer.

- 281 No interoperability tests shall be carried out by the laboratory, for a recording equipment or a tachograph card that have not been granted a security certificate and a functional certificate.
- 282 Any manufacturer requesting interoperability tests shall commit to leave to the laboratory in charge of these tests the entire set of material and documents which he provided to carry out the tests.

- 283 The interoperability tests shall be carried out, in accordance with the provisions of paragraph 5 of Appendix 9 of this Annex, with respectively all the types of recording equipment or tachograph cards:
- for which type approval is still valid, or
  - for which type approval is pending and that have a valid interoperability certificate.
- 284 The interoperability certificate shall be delivered by the laboratory to the manufacturer only after all required interoperability tests have been successfully passed.
- 285 If the interoperability tests are not successful with one or more of the recording equipment or tachograph card(s), as requested by requirement 283, the interoperability certificate shall not be delivered, until the requesting manufacturer has realised the necessary modifications and has succeeded with the interoperability tests. The laboratory shall identify the cause of the problem with the help of the manufacturers concerned by this interoperability fault and shall attempt to help the requesting manufacturer in finding a technical solution. In the case where the manufacturer has modified its product, it is the manufacturer's responsibility to ascertain from the relevant authorities that the security certificate and the functional certificates are still valid.
- 286 The interoperability certificate is valid for six months. It is revoked at the end of this period if the manufacturer has not received a corresponding type approval certificate. It is forwarded by the manufacturer to the type approval authority of the Member State who has delivered the functional certificate.
- 287 Any element that could be at the origin of an interoperability fault shall not be used for profit or to lead to a dominant position.

#### 5. Type approval certificate

- 288 The type approval authority of the Member State may deliver the type approval certificate as soon as it holds the three required certificates.
- 289 The type approval certificate shall be copied by the type approval authority to the laboratory in charge of the interoperability tests at the time of deliverance to the manufacturer.
- 290 The laboratory competent for interoperability tests shall run a public web site on which will be updated the list of recording equipment or tachograph cards models:
- for which a request for interoperability tests have been registered,
  - having received an interoperability certificate (even provisional),
  - having received a type approval certificate.

#### 6. Exceptional procedure: first interoperability certificates

- 291 Until four months after a first couple of recording equipment and tachograph cards (driver, workshop, control and company cards) have been certified to be interoperable, any interoperability certificate delivered (including this very first one), regarding requests registered during this period, shall be considered provisional.
- 292 If at the end of this period, all products concerned are mutually interoperable, all corresponding interoperability certificates shall become definitive.
- 293 If during this period, interoperability faults are found, the laboratory in charge of interoperability tests shall identify the causes of the problems with the help of all manufacturers involved and shall invite them to realise the necessary modifications.
- 294 If at the end of this period, interoperability problems still remain, the laboratory in charge of interoperability tests, with the collaboration of the manufacturers concerned and with the type approval authorities who delivered the corresponding functional certificates shall find out the causes of the interoperability faults and establish which modifications should be made by each of the manufacturers concerned. The search for technical solutions shall last for a maximum of two months, after which, if no common solution is found, the Commission, after having consulted the laboratory in charge of interoperability tests, shall decide which equipment(s) and cards get a definitive interoperability certificate and state the reasons why.
- 295 Any request for interoperability tests, registered by the laboratory between the end of the four-month period after the first provisional interoperability certificate has been delivered and the date of the decision by the Commission referred to in requirement 294, shall be postponed until the initial interoperability problems have been solved. Those requests are then processed in the chronological order of their registration.



*Appendix 1***DATA DICTIONARY**

## CONTENTS

1.	Introduction .....	54
1.1.	Approach for definitions of data types .....	54
1.2.	References .....	54
2.	Data Type Definitions .....	55
2.1.	ActivityChangeInfo .....	55
2.2.	Address .....	56
2.3.	BCDString .....	56
2.4.	CalibrationPurpose .....	56
2.5.	CardActivityDailyRecord .....	57
2.6.	CardActivityLengthRange .....	57
2.7.	CardApprovalNumber .....	57
2.8.	CardCertificate .....	57
2.9.	CardChipIdentification .....	57
2.10.	CardConsecutiveIndex .....	58
2.11.	CardControlActivityDataRecord .....	58
2.12.	CardCurrentUse .....	58
2.13.	CardDriverActivity .....	58
2.14.	CardDrivingLicenceInformation .....	59
2.15.	CardEventData .....	59
2.16.	CardEventRecord .....	59
2.17.	CardFaultData .....	60
2.18.	CardFaultRecord .....	60
2.19.	CardIccIdentification .....	60
2.20.	CardIdentification .....	61
2.21.	CardNumber .....	61
2.22.	CardPlaceDailyWorkPeriod .....	61
2.23.	CardPrivateKey .....	62
2.24.	CardPublicKey .....	62
2.25.	CardRenewalIndex .....	62
2.26.	CardReplacementIndex .....	62
2.27.	CardSlotNumber .....	62
2.28.	CardSlotsStatus .....	62
2.29.	CardStructureVersion .....	63

2.30.	CardVehicleRecord	63
2.31.	CardVehiclesUsed	63
2.32.	Certificate	64
2.33.	CertificateContent	64
2.34.	CertificateHolderAuthorisation	64
2.35.	CertificateRequestID	65
2.36.	CertificationAuthorityKID	65
2.37.	CompanyActivityData	65
2.38.	CompanyActivityType	66
2.39.	CompanyCardApplicationIdentification	66
2.40.	CompanyCardHolderIdentification	66
2.41.	ControlCardApplicationIdentification	67
2.42.	ControlCardControlActivityData	67
2.43.	ControlCardHolderIdentification	67
2.44.	ControlType	68
2.45.	CurrentDateTime	68
2.46.	DailyPresenceCounter	68
2.47.	Datef	69
2.48.	Distance	69
2.49.	DriverCardApplicationIdentification	69
2.50.	DriverCardHolderIdentification	69
2.51.	EntryTypeDailyWorkPeriod	70
2.52.	EquipmentType	70
2.53.	EuropeanPublicKey	70
2.54.	EventFaultType	70
2.55.	EventFaultRecordPurpose	71
2.56.	ExtendedSerialNumber	72
2.57.	FullCardNumber	72
2.58.	HighResOdometer	72
2.59.	HighResTripDistance	72
2.60.	HolderName	72
2.61.	K-ConstantOfRecordingEquipment	73
2.62.	KeyIdentifier	73
2.63.	L-TyreCircumference	73
2.64.	Language	73
2.65.	LastCardDownload	73
2.66.	ManualInputFlag	73
2.67.	ManufacturerCode	74

2.68.	MemberStateCertificate .....	74
2.69.	MemberStatePublicKey .....	75
2.70.	Name .....	75
2.71.	NationAlpha .....	75
2.72.	NationNumeric .....	76
2.73.	NoOfCalibrationRecords .....	77
2.74.	NoOfCalibrationSinceDownload .....	77
2.75.	NoOfCardPlaceRecords .....	77
2.76.	NoOfCardVehicleRecords .....	77
2.77.	NoOfCompanyActivityRecords .....	77
2.78.	NoOfControlActivityRecords .....	78
2.79.	NoOfEventsPerType .....	78
2.80.	NoOfFaultsPerType .....	78
2.81.	OdometerValueMidnight .....	78
2.82.	OdometerShort .....	78
2.83.	OverspeedNumber .....	78
2.84.	PlaceRecord .....	78
2.85.	PreviousVehicleInfo .....	79
2.86.	PublicKey .....	79
2.87.	RegionAlpha .....	79
2.88.	RegionNumeric .....	79
2.89.	RSAPublicModulus .....	80
2.90.	RSAPrivateExponent .....	80
2.91.	RSAPublicExponent .....	80
2.92.	SensorApprovalNumber .....	80
2.93.	SensorIdentification .....	80
2.94.	SensorInstallation .....	81
2.95.	SensorInstallationSecData .....	81
2.96.	SensorOSIdentifier .....	81
2.97.	SensorPaired .....	81
2.98.	SensorPairingDate .....	82
2.99.	SensorSerialNumber .....	82
2.100.	SensorSCIdentifier .....	82
2.101.	Signature .....	82
2.102.	SimilarEventsNumber .....	82
2.103.	SpecificConditionType .....	82
2.104.	SpecificConditionRecord .....	82
2.105.	Speed .....	83

2.106.	SpeedAuthorised	83
2.107.	SpeedAverage	83
2.108.	SpeedMax	83
2.109.	TDesSessionKey	83
2.110.	TimeReal	83
2.111.	TyreSize	83
2.112.	VehicleIdentificationNumber	84
2.113.	VehicleRegistrationIdentification	84
2.114.	VehicleRegistrationNumber	84
2.115.	VuActivityDailyData	84
2.116.	VuApprovalNumber	84
2.117.	VuCalibrationData	84
2.118.	VuCalibrationRecord	85
2.119.	VuCardIWDData	85
2.120.	VuCardIWRRecord	86
2.121.	VuCertificate	86
2.122.	VuCompanyLocksData	86
2.123.	VuCompanyLocksRecord	87
2.124.	VuControlActivityData	87
2.125.	VuControlActivityRecord	87
2.126.	VuDataBlockCounter	87
2.127.	VuDetailedSpeedBlock	87
2.128.	VuDetailedSpeedData	88
2.129.	VuDownloadablePeriod	88
2.130.	VuDownloadActivityData	88
2.131.	VuEventData	88
2.132.	VuEventRecord	89
2.133.	VuFaultData	89
2.134.	VuFaultRecord	89
2.135.	VuIdentification	90
2.136.	VuManufacturerAddress	90
2.137.	VuManufacturerName	90
2.138.	VuManufacturingDate	90
2.139.	VuOverSpeedingControlData	91
2.140.	VuOverSpeedingEventData	91
2.141.	VuOverSpeedingEventRecord	91
2.142.	VuPartNumber	91
2.143.	VuPlaceDailyWorkPeriodData	92

2.144.	VuPlaceDailyWorkPeriodRecord	92
2.145.	VuPrivateKey	92
2.146.	VuPublicKey	92
2.147.	VuSerialNumber	92
2.148.	VuSoftInstallationDate	92
2.149.	VuSoftwareIdentification	92
2.150.	VuSoftwareVersion	93
2.151.	VuSpecificConditionData	93
2.152.	VuTimeAdjustmentData	93
2.153.	VuTimeAdjustmentRecord	93
2.154.	W-VehicleCharacteristicConstant	93
2.155.	WorkshopCardApplicationIdentification	94
2.156.	WorkshopCardCalibrationData	94
2.157.	WorkshopCardCalibrationRecord	94
2.158.	WorkshopCardHolderIdentification	95
2.159.	WorkshopCardPIN	95
3.	Value and size range definitions	96
3.1.	Definitions for the Driver Card	96
3.2.	Definitions für the Workshop Card	96
3.3.	Definitions for the Control Card	96
3.4.	Definitions for the Company Card	96
4.	Character sets	96
5.	Encoding	96

## 1. INTRODUCTION

This appendix specifies data formats, data elements, and data structures for use within the recording equipment and tachograph cards.

### 1.1. Approach for definitions of data types

This appendix uses Abstract Syntax Notation One (ASN.1) to define data types. This enables simple and structured data to be defined without implying any specific transfer syntax (encoding rules) which will be application and environment dependent.

ASN.1 type naming conventions are done in accordance with ISO/IEC 8824-1. This implies that:

- where possible, the meaning of the data type is implied through the names being selected,
- where a data type is a composition of other data types, the data type name is still a single sequence of alphabetical characters commencing with a capital letter, however capitals are used within the name to impart the corresponding meaning,
- in general, the data types names are related to the name of the data types from which they are constructed, the equipment in which data is stored and the function related to the data.

If an ASN.1 type is already defined as part of another standard and if it is relevant for usage in the recording equipment, then this ASN.1 type will be defined in this appendix.

To enable several types of encoding rules, some ASN.1 types in this appendix are constrained by value range identifiers. The value range identifiers are defined in paragraph 3.

### 1.2. References

The following references are used in this Appendix:

- |                |  |
|----------------|--|
| ISO 639        | Code for the representation of names of languages. First Edition: 1988   |
| EN 726-3       | Identification cards systems — Telecommunications integrated circuit(s) cards and terminals — Part 3: Application independent card requirements. December 1994   |
| ISO 3779       | Road vehicles — Vehicle identification number (VIN) — Content and structure. Edition 3: 1983   |
| ISO/IEC 7816-5 | Information technology — Identification cards — Integrated circuit(s) cards with contacts — Part 5: Numbering system and registration procedure for application identifiers. First edition: 1994 + Amendment 1: 1996 |
| ISO/IEC 8824-1 | Information technology — Abstract Syntax Notation 1 (ASN.1): Specification of basic notation. Edition 2: 1998  |
| ISO/IEC 8825-2 | Information technology — ASN.1 encoding rules: Specification of Packed Encoding Rules (PER). Edition 2: 1998   |
| ISO/IEC 8859-1 | Information technology — 8 bit single-byte coded graphic character sets — Part 1: Latin alphabet No 1. First edition: 1998   |
| ISO/IEC 8859-7 | Information technology — 8 bit single-byte coded graphic character sets — Part 7: Latin/Greek alphabet. First edition: 1987  |
| ISO 16844-3    | Road vehicles — Tachograph systems — Motion Sensor Interface. WD 3-20/05/99.   |

## 2. DATA TYPE DEFINITIONS

For any of the following data types, the default value for an "unknown" or a "not applicable" content will consist in filling the data element with 'FF'-Bytes.

### 2.1. ActivityChangeInfo

This data type enables to code, within a two bytes word, a slot status at 00.00 and/or a driver status at 00.00 and/or changes of activity and/or changes of driving status and/or changes of card status for a driver or a co-driver. This data type is related to requirements 084, 109a, 199 and 219.

ActivityChangeInfo ::= OCTET STRING (SIZE (2))

**Value assignment — Octet Aligned:** 'scpaattttttttttt'B (16 bits)

For Data Memory recordings (or slot status):

's'B	Slot:
	'0'B: DRIVER,
	'1'B: CO-DRIVER,
'c'B	Driving status:
	'0'B: SINGLE,
	'1'B: CREW,
'p'B	Driver (or workshop) card status in the relevant slot:
	'0'B: INSERTED, a card is inserted,
	'1'B: NOT INSERTED, no card is inserted (or a card is withdrawn),
'aa'B	Activity:
	'00'B: BREAK/REST,
	'01'B: AVAILABILITY,
	'10'B: WORK,
	'11'B: DRIVING,
'ttttttttttt'B	Time of the change: Number of minutes since 00h00 on the given day.

For Driver (or Workshop) card recordings (and driver status):

's'B	Slot (not relevant when 'p' = 1 except note below):
	'0'B: DRIVER,
	'1'B: 2. CO-DRIVER,
'c'B	Driving status (case 'p' = 0) or                      Following activity status (case 'p' = 1):
	'0'B: SINGLE,    '0'B: UNKNOWN
	'1'B: CREW,    '1'B: KNOWN (= manually entered)
'p'B	Card status:
	'0'B: INSERTED, the card is inserted in a recording equipment,
	'1'B: NOT INSERTED, the card is not inserted (or the card is withdrawn),

'aa'B Activity (not relevant when 'p' = 1 and 'c' = 0 except note below):  
 '00'B: BREAK/REST,  
 '01'B: AVAILABILITY,  
 '10'B: WORK,  
 '11'B: DRIVING,  
 'tttttttttt'B Time of the change: Number of minutes since 00h00 on the given day.

**Note for the case "card withdrawal":**

When the card is withdrawn:

- 's' is relevant and indicates the slot from which the card is withdrawn,
- 'c' must be set to 0,
- 'p' must be set to 1,
- 'aa' must code the current activity selected at that time,

As a result of a manual entry, the bits 'c' and 'aa' of the word (stored in a card) may be overwritten later to reflect the entry.

## 2.2. Address

An address.

```
address ::= SEQUENCE {
    codePage          INTEGER (0..255),
    address           OCTET STRING (SIZE(35))
}
```

**codePage** specifies the part of the ISO/IEC 8859 used to code the address,

**address** is an address coded in accordance with ISO/IEC 8859-codePage.

## 2.3. BCDString

BCDString is applied for Binary Code Decimal (BCD) representation. This data type is used to represent one decimal digit in one semi octet (4 bits). BCDString is based on the ISO/IEC 8824-1 'CharacterStringType'.

```
BCDString ::= CHARACTER STRING (WITH COMPONENTS {
    identification ( WITH COMPONENTS {
        fixed PRESENT } ) } )
```

BCDString uses an "hstring" notation. The leftmost hexadecimal digit shall be the most significant semi octet of the first octet. To produce a multiple of octets, zero trailing semi octets shall be inserted, as needed, from the leftmost semi octet position in the first octet.

Permitted digits are: 0, 1, ... 9.

## 2.4. CalibrationPurpose

Code explaining why a set of calibration parameters was recorded. This data type is related to requirements 097 and 098.

```
CalibrationPurpose ::= OCTET STRING (SIZE(1)).
```

**Value assignment:**

'00'H reserved value,

'01'H activation: recording of calibration parameters known, at the moment of the VU activation,



'02'H first installation: first calibration of the VU after its activation,

'03'H installation: first calibration of the VU in the current vehicle,

'04'H periodic inspection.

## 2.5. CardActivityDailyRecord

Information, stored in a card, related to the driver activities for a particular calendar day. This data type is related to requirements 199 and 219.

```
CardActivityDailyRecord ::= SEQUENCE {
    activityPreviousRecordLength      INTEGER(0..CardActivityLengthRange),
    activityRecordDate                TimeReal,
    activityDailyPresenceCounter      DailyPresenceCounter,
    activityDayDistance               Distance,
    activityChangeInfo                SET SIZE(1..1440) OF ActivityChangeInfo
}
```

**activityPreviousRecordLength** is the total length in bytes of the previous daily record. The maximum value is given by the length of the OCTET STRING containing these records (see CardActivityLengthRange paragraph 3). When this record is the oldest daily record, the value of activityPreviousRecordLength must be set to 0.

**activityRecordLength** is the total length in bytes of this record. The maximum value is given by the length of the OCTET STRING containing these records.

**activityRecordDate** is the date of the record.

**activityDailyPresenceCounter** is the daily presence counter for the card this day.

**activityDayDistance** is the total distance travelled this day.

**activityChangeInfo** is the set of ActivityChangeInfo data for the driver this day. It may contain at maximum 1 440 values (one activity change per minute). This set always includes the activityChangeInfo coding the driver status at 00.00.

## 2.6. CardActivityLengthRange

Number of bytes in a driver or a workshop card, available to store driver activity records.

```
CardActivityLengthRange ::= INTEGER(0..216-1)
```

**Value assignment:** see paragraph 3.

## 2.7. CardApprovalNumber

Type approval number of the card.

```
CardApprovalNumber ::= IA5String(SIZE(8))
```

**Value assignment:** Unspecified.

## 2.8. CardCertificate

Certificate of the public key of a card.

```
CardCertificate ::= Certificate.
```

## 2.9. CardChipIdentification

Information, stored in a card, related to the identification of the card's Integrated Circuit (IC) (requirement 191).

```
CardChipIdentification ::= SEQUENCE {
    icSerialNumber                    OCTET STRING (SIZE(4)),
    icManufacturingReferences         OCTET STRING (SIZE(4))
}
```



**activityPointerOldestDayRecord** is the specification of the begin of the storage place (number of bytes from the beginning of the string) of the oldest complete day record in the activityDailyRecords string. The maximum value is given by the length of the string.

**activityPointerNewestRecord** is the specification of the begin of the storage place (number of bytes from the beginning of the string) of the most recent day record in the activityDailyRecords string. The maximum value is given by the length of the string.

**activityDailyRecords** is the space available to store the driver activity data (data structure: CardActivityDailyRecord) for each calendar day where the card has been used.

**Value assignment:** this octet string is cyclically filled with records of CardActivityDailyRecord. At the first use storing is started at the first byte of the string. All new records are appended at the end of the previous one. When the string is full, storing continues at the first byte of the string independently of a break being inside a data element. Before placing new activity data in the string (enlarging current activityDailyRecord, or placing a new activityDailyRecord) that replaces older activity data, activityPointerOldestDayRecord must be updated to reflect the new location of the oldest complete day record, and activityPreviousRecordLength of this (new) oldest complete day record must be reset to 0.

#### 2.14. CardDrivingLicenceInformation

Information, stored in a driver card, related to the card holder driver licence data (requirement 196).

```
CardDrivingLicenceInformation ::= SEQUENCE {
    drivingLicenceIssuingAuthority      Name,
    drivingLicenceIssuingNation         NationNumeric,
    drivingLicenceNumber                IA5String(SIZE(16))
}
```

**drivingLicenceIssuingAuthority** is the authority responsible for issuing the driving licence.

**drivingLicenceIssuingNation** is the nationality of the authority that issued the driving licence.

**drivingLicenceNumber** is the number of the driving licence.

#### 2.15. CardEventData

Information, stored in a driver or workshop card, related to the events associated with the card holder (requirements 204 and 223).

```
CardEventData ::= SEQUENCE SIZE(6) OF {
    cardEventRecords                SET SIZE(NoOfEventsPerType) OF
                                     CardEventRecord
}
```

**CardEventData** is a sequence, ordered by ascending value of EventFaultType, of cardEventRecords (except security breach attempts related records which are gathered in the last set of the sequence).

**cardEventRecords** is a set of event records of a given event type (or category for security breach attempts events).

#### 2.16. CardEventRecord

Information, stored in a driver or a workshop card, related to an event associated to the card holder (requirements 205 and 223).

```
CardEventRecord ::= SEQUENCE {
    eventType                        EventFaultType,
    eventBeginTime                   TimeReal,
    eventEndTime                     TimeReal,
    eventVehicleRegistration         VehicleRegistrationIdentification
}
```

**eventType** is the type of the event.

**eventBeginTime** is the date and time of beginning of event.

**eventEndTime** is the date and time of end of event.

**eventVehicleRegistration** is the VRN and registering Member State of vehicle in which the event happened.

### 2.17. CardFaultData

Information, stored in a driver or a workshop card, related to the faults associated to the card holder (requirements 207 and 223).

```
CardFaultData ::= SEQUENCE (2) OF {
    cardFaultRecords                SET SIZE (NoOfFaultsPerType) OF
                                   CardFaultRecord
}
```

**CardFaultData** is a sequence of Recording Equipment faults set of records followed by card faults set of records.

**cardFaultRecords** is a set of fault records of a given fault category (Recording Equipment or card).

### 2.18. CardFaultRecord

Information, stored in a driver or a workshop card, related to a fault associated to the card holder (requirement 208 and 223).

```
CardFaultRecord ::= SEQUENCE {
    faultType                        EventFaultType,
    faultBeginTime                   TimeReal,
    faultEndTime                     TimeReal,
    faultVehicleRegistration          VehicleRegistrationIdentification
}
```

**faultType** is the type of the fault.

**faultBeginTime** is the date and time of beginning of fault.

**faultEndTime** is the date and time of end of fault.

**faultVehicleRegistration** is the VRN and registering Member State of vehicle in which the fault happened.

### 2.19. CardIccIdentification

Information, stored in a card, related to the identification of the integrated circuit (IC) card (requirement 192).

```
CardIccIdentification ::= SEQUENCE {
    clockStop                        OCTET STRING (SIZE (1)),
    cardExtendedSerialNumber         ExtendedSerialNumber,
    cardApprovalNumber               CardApprovalNumber
    cardPersonaliserID                OCTET STRING (SIZE (1)),
    embedderIcAssemblerId            OCTET STRING (SIZE (5)),
    icIdentifier                      OCTET STRING (SIZE (2))
}
```

**clockStop** is the Clockstop mode as defined in EN 726-3.

**cardExtendedSerialNumber** is the IC card serial number and IC card manufacturing reference as defined in EN 726-3 and as further specified by the ExtendedSerialNumber data type.

**cardApprovalNumber** is the type approval number of the card.

**cardPersonaliserID** is the card personaliser ID as defined in EN 726-3.

**embedderIcAssemblerId** is the embedder/IC assembler identifier as defined in EN 726-3.

**icIdentifier** is the Identifier of the IC on the card and its IC manufacturer as defined in EN 726-3.

## 2.20. CardIdentification

Information, stored in a card, related to the identification of the card (requirements 194, 215, 231, 235).

`CardIdentification ::= SEQUENCE`

```

    cardIssuingMemberState      NationNumeric ,
    cardNumber                  CardNumber ,
    cardIssuingAuthorityName    Name ,
    cardIssueDate               TimeReal ,
    cardValidityBegin           TimeReal ,
    cardExpiryDate              TimeReal
}

```

**cardIssuingMemberState** is the code of the Member State issuing the card.

**cardNumber** is the card number of the card.

**cardIssuingAuthorityName** is the name of the authority having issued the Card.

**cardIssueDate** is the issue date of the Card to the current holder.

**cardValidityBegin** is the first date of validity of the card.

**cardExpiryDate** is the date when the validity of the card ends.

## 2.21. CardNumber

A card number as defined by definition g).

`CardNumber ::= CHOICE {`

```

    SEQUENCE {
        driverIdentification      IA5String(SIZE(14)),
        cardReplacementIndex      CardReplacementIndex,
        cardRenewalIndex          CardRenewalIndex
    }
    SEQUENCE {
        ownerIdentification        IA5String(SIZE(13)),
        cardConsecutiveIndex       CardConsecutiveIndex,
        cardReplacementIndex       CardReplacementIndex,
        cardRenewalIndex           CardRenewalIndex
    }
}

```

**driverIdentification** is the unique identification of a driver in a Member State.

**ownerIdentification** is the unique identification of a company or a workshop or a control body within a Member State.

**cardConsecutiveIndex** is the card consecutive index.

**cardReplacementIndex** is the card replacement index.

**cardRenewalIndex** is the card renewal index.

The first sequence of the choice is suitable to code a driver card number, the second sequence of the choice is suitable to code workshop, control, and company card numbers.

## 2.22. CardPlaceDailyWorkPeriod

Information, stored in a driver or a workshop card, related to the places where daily work periods begin and/or end (requirements 202 and 221).

```

CardPlaceDailyWorkPeriod ::= SEQUENCE {
    placePointerNewestRecord          INTEGER(0..NoOfCardPlaceRecords-1),
    placeRecords SET                  SIZE(NoOfCardPlaceRecords) OF PlaceRecord
}

```

**placePointerNewestRecord** is the index of the last updated place record.

**Value assignment:** Number corresponding to the numerator of the place record, beginning with "0" for the first occurrence of the place records in the structure.

**placeRecords** is the set of records containing the information related to the places entered.

### 2.23. CardPrivateKey

The private key of a card.

```
CardPrivateKey ::= RSAKeyPrivateExponent.
```

### 2.24. CardPublicKey

The public key of a card.

```
CardPublicKey ::= PublicKey.
```

### 2.25. CardRenewalIndex

A card renewal index (definition i)).

```
CardRenewalIndex ::= IA5String(SIZE(1)).
```

**Value assignment:** (see this Annex Chapter VII).

'0' First issue.

Order for increase: '0, ..., 9, A, ..., Z'.

### 2.26. CardReplacementIndex

A card replacement index (definition j)).

```
CardReplacementIndex ::= IA5String(SIZE(1))
```

**Value assignment:** (see this Annex Chapter VII).

'0' Original card.

Order for increase: '0, ..., 9, A, ..., Z'.

### 2.27. CardSlotNumber

Code to distinguish between the two slots of a vehicle unit.

```

CardSlotNumber ::= INTEGER {
    driverSlot          (0),
    co-driverSlot      (1)
}

```

**Value assignment:** not further specified.

### 2.28. CardSlotsStatus

Code indicating the type of cards inserted in the two slots of the vehicle unit.

```
CardSlotsStatus ::= OCTET STRING (SIZE(1))
```

**Value assignment — Octet Aligned:** 'ccccddd'B:

'cccc'B Identification of the type of card inserted in the co-driver slot,

'ddd'B Identification of the type of card inserted in the driver slot,

with the following identification codes:

'0000'B no card is inserted,

'0001'B a driver card is inserted,

'0010'B a workshop card is inserted,

'0011'B a control card is inserted,

'0100'B a company card is inserted.

### 2.29. CardStructureVersion

Code indicating the version of the implemented structure in a tachograph card.

CardStructureVersion ::= OCTET STRING (SIZE(2))

**Value assignment:** 'aabb'H:

'aa'H Index for changes of the structure,

'bb'H Index for changes concerning the use of the data elements defined for the structure given by the high byte.

### 2.30. CardVehicleRecord

Information, stored in a driver or workshop card, related to a period of use of a vehicle during a calendar day (requirements 197 and 217).

```
CardVehicleRecord ::= SEQUENCE {
    vehicleOdometerBegin           OdometerShort,
    vehicleOdometerEnd            OdometerShort,
    vehicleFirstUse                TimeReal,
    vehicleLastUse                TimeReal,
    vehicleRegistration            VehicleRegistrationIdentification,
    vuDataBlockCounter            VuDataBlockCounter
}
```

**vehicleOdometerBegin** is the vehicle odometer value at the beginning of the period of use of the vehicle.

**vehicleOdometerEnd** is the vehicle odometer value at the end of the period of use of the vehicle.

**vehicleFirstUse** is the date and time of the beginning of the period of use of the vehicle.

**vehicleLastUse** is the date and time of the end of the period of use of the vehicle.

**vehicleRegistration** is the VRN and the registering Member State of the vehicle.

**vuDataBlockCounter** is the value of the VuDataBlockCounter at last extraction of the period of use of the vehicle.

### 2.31. CardVehiclesUsed

Information, stored in a driver or workshop card, related to the vehicles used by the card holder (requirements 197 and 217).

```
CardVehiclesUsed ::= SEQUENCE {
    vehiclePointerNewestRecord    INTEGER(0..NoOfCardVehicleRecords-1),
    cardVehicleRecords            SET SIZE(NoOfCardVehicleRecords) OF
    CardVehicleRecord
}
```

**vehiclePointerNewestRecord** is the index of the last updated vehicle record.

**Value assignment:** Number corresponding to the numerator of the vehicle record, beginning with '0' for the first occurrence of the vehicle records in the structure.

**cardVehicleRecords** is the set of records containing information on vehicles used.

### 2.32. Certificate

The certificate of a public key issued by a Certification Authority.

```
Certificate ::= OCTET STRING (SIZE(194))
```

**Value assignment:** digital signature with partial recovery of a CertificateContent according to Appendix 11 "common security mechanisms": Signature (128 bytes) || Public Key remainder (58 Byte) || Certification Authority Reference (8 bytes).

### 2.33. CertificateContent

The (clear) content of the certificate of a public key according to Appendix 11 common security mechanisms.

```
CertificateContent ::= SEQUENCE {
    certificateProfileIdentifier          INTEGER(0..255),
    certificationAuthorityReference      KeyIdentifier,
    certificateHolderAuthorisation       CertificateHolderAuthorisation,
    certificateEndOfValidity             TimeReal,
    certificateHolderReference           KeyIdentifier,
    publicKey                            PublicKey
}
```

**certificateProfileIdentifier** is the version of the corresponding certificate.

**Value assignment:** '01h' for this version.

**CertificationAuthorityReference** identifies the Certification Authority issuing the certificate. It also references the Public Key of this Certification Authority.

**certificateHolderAuthorisation** identifies the rights of the certificate holder.

**certificateEndOfValidity** is the date when the certificate expires administratively.

**certificateHolderReference** identifies the certificate holder. It also references his Public Key.

**publicKey** is the public key that is certified by this certificate.

### 2.34. CertificateHolderAuthorisation

Identification of the rights of a certificate holder.

```
CertificateHolderAuthorisation ::= SEQUENCE {
    tachographApplicationID             OCTET STRING(SIZE(6))
    equipmentType                       EquipmentType
}
```

**tachographApplicationID** is the application identifier for the tachograph application.

**Value assignment:** 'FFh' '54h' '41h' '43h' '48h' '4Fh'. This AID is a proprietary non-registered application identifier in accordance with ISO/IEC 7816-5.

**equipmentType** is the identification of the type of equipment to which the certificate is intended.

**Value assignment:** in accordance with EquipmentType data type. 0 if certificate is the one of a Member State.



### 2.35. CertificateRequestID

Unique identification of a certificate request. It can also be used as a Vehicle Unit Public Key Identifier if the serial number of the vehicle Unit to which the key is intended is not known at certificate generation time.

```
CertificateRequestID ::= SEQUENCE {
    requestSerialNumber          INTEGER(0..232-1)
    requestMonthYear             BCDString(SIZE(2))
    crIdentifier                  OCTET STRING(SIZE(1))
    manufacturerCode             ManufacturerCode
}
```

**requestSerialNumber** is a serial number for the certificate request, unique for the manufacturer and the month below.

**requestMonthYear** is the identification of the month and the year of the certificate request.

**Value assignment:** BCD coding of month (two digits) and year (two last digits).

**crIdentifier:** is an identifier to distinguish a certificate request from an extended serial number.

**Value assignment:** 'FFh'.

**manufacturerCode:** is the numerical code of the manufacturer requesting the certificate.

### 2.36. CertificationAuthorityKID

Identifier of the Public Key of a Certification Authority (a Member State or the European Certification Authority).

```
CertificationAuthorityKID ::= SEQUENCE {
    nationNumeric                NationNumeric
    nationAlpha                  NationAlpha
    keySerialNumber              INTEGER(0..255)
    additionalInfo               OCTET STRING(SIZE(2))
    caIdentifier                  OCTET STRING(SIZE(1))
}
```

**nationNumeric** is the numerical nation code of the Certification Authority.

**nationAlpha** is the alphanumerical nation code of the Certification Authority.

**keySerialNumber** is a serial number to distinguish the different keys of the Certification Authority in the case keys are changed.

**additionalInfo** is a two byte field for additional coding (Certification Authority specific).

**caIdentifier** is an identifier to distinguish a Certification Authority Key Identifier from other Key Identifiers.

**Value assignment:** '01h'.

### 2.37. CompanyActivityData

Information, stored in a company card, related to activities performed with the card (requirement 237).

```
CompanyActivityData ::= SEQUENCE {
    companyPointerNewestRecord    INTEGER(0..NoOfCompanyActivityRecords-1),
    companyActivityRecords       SET SIZE(NoOfCompanyActivityRecords) OF
        companyActivityRecord     SEQUENCE {
            companyActivityType    CompanyActivityType,
            companyActivityTime    TimeReal,
            cardNumberInformation  FullCardNumber,
```

```

        vehicleRegistrationInformation      VehicleRegistrationIdentification,
        downloadPeriodBegin                TimeReal,
        downloadPeriodEnd                  TimeReal
    }
}

```

**companyPointerNewestRecord** is the index of the last updated companyActivityRecord.

**Value assignment:** Number corresponding to the numerator of the company activity record, beginning with '0' for the first occurrence of the company activity record in the structure.

**companyActivityRecords** is the set of all company activity records.

**companyActivityRecord** is the sequence of information related to one company activity.

**companyActivityType** is the type of the company activity.

**companyActivityTime** is the date and time of the company activity.

**cardNumberInformation** is the card number and the card issuing Member State of the card downloaded, if any.

**vehicleRegistrationInformation** is the VRN and registering Member State of the vehicle downloaded or locked in or out.

**downloadPeriodBegin** and **downloadPeriodEnd** is the period downloaded from the VU, if any.

### 2.38. CompanyActivityType

Code indicating an activity carried out by a company using its company card.

```

CompanyActivityType ::= INTEGER {
    card downloading                (1),
    VU downloading                  (2),
    VU lock-in                      (3),
    VU lock-out                     (4).
}

```

### 2.39. CompanyCardApplicationIdentification

Information, stored in a company card related to the identification of the application of the card (requirement 190).

```

CompanyCardApplicationIdentification ::= SEQUENCE {
    typeOfTachographCardId          EquipmentType,
    cardStructureVersion             CardStructureVersion,
    noOfCompanyActivityRecords      NoOfCompanyActivityRecords
}

```

**typeOfTachographCardId** is specifying the implemented type of card.

**cardStructureVersion** is specifying the version of the structure that is implemented in the card.

**noOfCompanyActivityRecords** is the number of company activity records the card can store.

### 2.40. CompanyCardHolderIdentification

Information, stored in a company card, related to the cardholder identification (requirement 236).

```

CompanyCardHolderIdentification ::= SEQUENCE {
    companyName                     Name,
    companyAddress                   Address,
    cardHolderPreferredLanguage     Language
}

```

**companyName** is the name of the holder company.

**companyAddress** is the address of the holder company.

**cardHolderPreferredLanguage** is the preferred language of the card holder.

#### 2.41. ControlCardApplicationIdentification

Information, stored in a control card related to the identification of the application of the card (requirement 190).

```
ControlCardApplicationIdentification ::= SEQUENCE {
    typeOfTachographCardId          EquipmentType,
    cardStructureVersion            CardStructureVersion,
    noOfControlActivityRecords      NoOfControlActivityRecords
}
```

**typeOfTachographCardId** is specifying the implemented type of card.

**cardStructureVersion** is specifying the version of the structure that is implemented in the card.

**noOfControlActivityRecords** is the number of control activity records the card can store.

#### 2.42. ControlCardControlActivityData

Information, stored in a control card, related to control activity performed with the card (requirement 233).

```
ControlCardControlActivityData ::= SEQUENCE {
    controlPointerNewestRecord      INTEGER(0..NoOfControlActivityRecords-1),
    controlActivityRecords          SET SIZE (NoOfControlActivityRecords) OF
        controlActivityRecord      SEQUENCE {
            controlType             ControlType,
            controlTime             TimeReal,
            controlledCardNumber    FullCardNumber,
            controlledVehicleRegistration VehicleRegistrationIdentification,
            controlDownloadPeriodBegin TimeReal,
            controlDownloadPeriodEnd TimeReal
        }
}
```

**controlPointerNewestRecord** is the index of the last updated control activity record.

**Value assignment:** Number corresponding to the numerator of the control activity record, beginning with '0' for the first occurrence of the control activity record in the structure.

**controlActivityRecords** is the set of all control activity records.

**controlActivityRecord** is the sequence of information related to one control.

**controlType** is the type of the control.

**controlTime** is the date and time of the control.

**controlledCardNumber** is the card number and the card issuing Member State of the card controlled.

**controlledVehicleRegistration** is the VRN and registering Member State of the vehicle in which the control happened.

**controlDownloadPeriodBegin** and **controlDownloadPeriodEnd** is the period eventually downloaded.

#### 2.43. ControlCardHolderIdentification

Information, stored in a control card, related to the identification of the cardholder (requirement 232).

```

ControlCardHolderIdentification ::= SEQUENCE {
    controlBodyName                Name,
    controlBodyAddress             Address,
    cardHolderName                 HolderName,
    cardHolderPreferredLanguage    Language
}

```

**controlBodyName** is the name of the control body of the card holder.

**controlBodyAddress** is the address of the control body of the card holder.

**cardHolderName** is the name and first name(s) of the holder of the Control Card.

**cardHolderPreferredLanguage** is the preferred language of the card holder.

#### 2.44. ControlType

Code indicating the activities carried out during a control. This data type is related to requirements 102, 210 and 225.

```
ControlType ::= OCTET STRING (SIZE(1))
```

**Value assignment — Octet aligned:** 'c'p'd'xxxx'B (8 bits)

```

'c'B    card downloading:
        '0'B: card not downloaded during this control activity,
        '1'B: card downloaded during this control activity
'v'B    VU downloading:
        '0'B: VU not downloaded during this control activity,
        '1'B: VU downloaded during this control activity
'p'B    printing:
        '0'B: no printing done during this control activity,
        '1'B: printing done during this control activity
'd'B    display:
        '0'B: no display used during this control activity,
        '1'B: display used during this control activity
'xxxx'B Not used.

```

#### 2.45. CurrentDateTime

The current date and time of the recording equipment.

```
CurrentDateTime ::= TimeReal
```

**Value assignment:** not further specified.

#### 2.46. DailyPresenceCounter

Counter, stored in a driver or workshop card, increased by one for each calendar day the card has been inserted in a VU. This data type is related to requirements 199 and 219.

```
DailyPresenceCounter ::= BCDString(SIZE(2))
```

**Value assignment:** Consecutive number with maximum value = 9 999, starting again with 0. At the time of first issuing of the card the number is set to 0.

**2.47. Datef**

Date expressed in a readily printable numeric format.

```
Datef ::= SEQUENCE {
    year      BCDString(SIZE(2)),
    month     BCDString(SIZE(1)),
    day       BCDString(SIZE(1))
}
```

**Value assignment:**

```
YYYY      Year
mm        Month
dd        Day
```

'00000000'H denotes explicitly no date.

**2.48. Distance**

A distance travelled (result of the calculation of the difference between two vehicle's odometer value in kilometres).

```
Distance ::= INTEGER(0..216-1)
```

**Value assignment:** Unsigned binary. Value in km in the operational range 0 to 9 999 km.

**2.49. DriverCardApplicationIdentification**

Information, stored in a driver card related to the identification of the application of the card (requirement 190).

```
DriverCardApplicationIdentification ::= SEQUENCE {
    typeOfTachographCardId      EquipmentType,
    cardStructureVersion         CardStructureVersion,
    noOfEventsPerType           NoOfEventsPerType,
    noOfFaultsPerType           NoOfFaultsPerType,
    activityStructureLength      CardActivityLengthRange,
    noOfCardVehicleRecords      NoOfCardVehicleRecords,
    noOfCardPlaceRecords        NoOfCardPlaceRecords
}
```

**typeOfTachographCardId** is specifying the implemented type of card.

**cardStructureVersion** is specifying the version of the structure that is implemented in the card.

**noOfEventsPerType** is the number of events per type of event the card can record.

**noOfFaultsPerType** is the number of faults per type of fault the card can record.

**activityStructureLength** indicates the number of bytes available for storing activity records.

**noOfCardVehicleRecords** is the number of vehicle records the card can contain.

**noOfCardPlaceRecords** is the number of places the card can record.

**2.50. DriverCardHolderIdentification**

Information, stored in a driver card, related to the identification of the cardholder (requirement 195).

```
DriverCardHolderIdentification ::= SEQUENCE {
    cardHolderName      HolderName,
    cardHolderBirthDate Datef,
    cardHolderPreferredLanguage Language
}
```

**cardHolderName** is the name and first name(s) of the holder of the Driver Card.

**cardHolderBirthDate** is the date of birth of the holder of the Driver Card.

**cardHolderPreferredLanguage** is the preferred language of the card holder.

### 2.51. EntryTypeDailyWorkPeriod

Code to distinguish between begin and end for an entry of a daily work period place and condition of the entry.

```
EntryTypeDailyWorkPeriod ::= INTEGER
    Begin, related time = card insertion time or time of entry           (0),
    End,   related time = card withdrawal time or time of entry         (1),
    Begin, related time manually entered (start time)                   (2),
    End,   related time manually entered (end of work period)           (3),
    Begin, related time assumed by VU                                   (4),
    End,   related time assumed by VU                                   (5)
}
```

**Value assignment:** according to ISO/IEC8824-1.

### 2.52. EquipmentType

Code to distinguish different types of equipment for the tachograph application.

```
EquipmentType ::= INTEGER(0..255)
-- Reserved                (0),
-- Driver Card             (1),
-- Workshop Card           (2),
-- Control Card            (3),
-- Company Card            (4),
-- Manufacturing Card      (5),
-- Vehicle Unit            (6),
-- Motion Sensor           (7),
-- RFU                     (8..255)
```

**Value assignment:** According to ISO/IEC 8824-1.

Value 0 is reserved for the purpose of designating a Member State or Europe in the CHA field of certificates.

### 2.53. EuropeanPublicKey

The European public key.

```
EuropeanPublicKey ::= PublicKey.
```

### 2.54. EventFaultType

Code qualifying an event or a fault.

```
EventFaultType ::= OCTET STRING (SIZE(1)).
```

**Value assignment:**

'0x'H	General events,
'00'H	No further details,
'01'H	Insertion of a non-valid card,
'02'H	Card conflict,
'03'H	Time overlap,
'04'H	Driving without an appropriate card,
'05'H	Card insertion while driving,
'06'H	Last card session not correctly closed,
'07'H	Over speeding,

'08'H	Power supply interruption,
'09'H	Motion data error,
'0A'H to '0F'H	RFU,
'1x'H	Vehicle unit related security breach attempt events,
'10'H	No further details,
'11'H	Motion sensor authentication failure,
'12'H	Tachograph card authentication failure,
'13'H	Unauthorised change of motion sensor,
'14'H	Card data input integrity error
'15'H	Stored user data integrity error,
'16'H	Internal data transfer error,
'17'H	Unauthorised case opening,
'18'H	Hardware sabotage,
'19'H to '1F'H	RFU,
'2x'H	Sensor related security breach attempt events,
'20'H	No further details,
'21'H	Authentication failure,
'22'H	Stored data integrity error,
'23'H	Internal data transfer error,
'24'H	Unauthorised case opening,
'25'H	Hardware sabotage,
'26'H to '2F'H	RFU,
'3x'H	Recording equipment faults,
'30'H	No further details,
'31'H	VU internal fault,
'32'H	Printer fault,
'33'H	Display fault,
'34'H	Downloading fault,
'35'H	Sensor fault,
'36'H to '3F'H	RFU
'4x'H	Card faults,
'40'H	No further details,
'41'H to '4F'H	RFU
'50'H to '7F'H	RFU,
'80'H to 'FF'H	Manufacturer specific.

### 2.55. EventFaultRecordPurpose

Code explaining why an event or a fault has been recorded.

EventFaultRecordPurpose ::= OCTET STRING (SIZE (1)).

#### Value assignment:

'00'H	one of the 10 most recent (or last) events or faults
'01'H	the longest event for one of the last 10 days of occurrence
'02'H	one of the 5 longest events over the last 365 days
'03'H	the last event for one of the last 10 days of occurrence
'04'H	the most serious event for one of the last 10 days of occurrence
'05'H	one of the 5 most serious events over the last 365 days
'06'H	the first event or fault having occurred after the last calibration
'07'H	an active/on-going event or fault
'08'H to '7F'H	RFU
'80'H to 'FF'H	manufacturer specific.

**2.56. ExtendedSerialNumber**

Unique identification of an equipment. It can also be used as an equipment Public Key Identifier.

```
ExtendedSerialNumber ::= SEQUENCE {
    serialNumber          INTEGER(0..232-1)
    monthYear            BCDString(SIZE(2))
    type OCTET           STRING(SIZE(1))
    manufacturerCode    ManufacturerCode
}
```

**serialNumber** is a serial number for the equipment, unique for the manufacturer, the equipment's type and the month below.

**monthYear** is the identification of the month and the year of manufacturing (or of serial number assignment).

**Value assignment:** BCD coding of Month (two digits) and Year (two last digits).

**type** is an identifier of the type of equipment.

**Value assignment:** manufacturer specific, with FFh' reserved value.

**manufacturerCode:** is the numerical code of the manufacturer of the equipment.

**2.57. FullCardNumber**

Code fully identifying a tachograph card.

```
FullCardNumber ::= SEQUENCE {
    cardType              EquipmentType,
    cardIssuingMemberState NationNumeric,
    cardNumber            CardNumber
}
```

**cardType** is the type of the tachograph card.

**cardIssuingMemberState** is the code of the Member State having issued the card.

**cardNumber** is the card number.

**2.58. HighResOdometer**

Odometer value of the vehicle: Accumulated distance travelled by the vehicle during its operation.

```
HighResOdometer ::= INTEGER(0..232-1)
```

**Value assignment:** Unsigned binary. Value in 1/200 km in the operating range 0 to 21 055 406 km.

**2.59. HighResTripDistance**

A distance travelled during all or part of a journey.

```
HighResTripDistance ::= INTEGER(0..232-1)
```

**Value assignment:** Unsigned binary. Value in 1/200 km in the operating range 0 to 21 055 406 km.

**2.60. HolderName**

The surname and first name(s) of a card holder.

```
HolderName ::= SEQUENCE {
    holderSurname          Name,
    holderFirstNames      Name
}
```



**holderSurname** is the surname (family name) of the holder. This surname does not include titles.

**Value assignment:** When a card is not personal, holderSurname contains the same information as companyName or workshopName or controlBodyName.

**holderFirstNames** is the first name(s) and initials of the holder.

#### 2.61. K-ConstantOfRecordingEquipment

Constant of the recording equipment (definition m)).

`K-ConstantOfRecordingEquipment ::= INTEGER(0..216-1)`

**Value assignment:** Pulses per kilometre in the operating range 0 to 64 255 pulses/km.

#### 2.62. KeyIdentifier

A unique identifier of a Public Key used to reference and select the key. It also identifies the holder of the key.

```
KeyIdentifier ::= CHOICE {
    extendedSerialNumber           ExtendedSerialNumber,
    certificateRequestID           CertificateRequestID,
    certificationAuthorityKID      CertificationAuthorityKID
}
```

The first choice is suitable to reference the public key of a Vehicle Unit or of a tachograph card.

The second choice is suitable to reference the public key of a Vehicle Unit (in the case the serial number of the Vehicle Unit cannot be known at certificate generation time).

The third choice is suitable to reference the public key of a Member State.

#### 2.63. L-TyreCircumference

Effective circumference of the wheel tyres (definition u)).

`L-TyreCircumference ::= INTEGER(0..216-1)`

**Value assignment:** Unsigned binary, value in 1/8 mm in the operating range 0 to 8 031 mm.

#### 2.64. Language

Code identifying a language.

`Language ::= IA5String(SIZE(2))`

**Value assignment:** Two-letter lower-case coding according to ISO 639.

#### 2.65. LastCardDownload

Date and time, stored on a driver card, of last card download (for other purposes than control). This date is updateable by a VU or any card reader.

`LastCardDownload ::= TimeReal`

**Value assignment:** not further specified.

#### 2.66. ManualInputFlag

Code identifying whether a cardholder has manually entered driver activities at card insertion or not (requirement 081).

```
ManualInputFlag ::= INTEGER {
    noEntry                (0)
    manualEntries          (1)
}
```

**Value assignment:** not further specified.

### 2.67. ManufacturerCode

Code identifying a manufacturer.

```
ManufacturerCode ::= INTEGER(0..255)
```

**Value assignment:**

'00'H	No information available
'01'H	Reserved value
'02'H .. '0F'H	Reserved for Future Use
'10'H	ACTIA
'11'H .. '17'H	Reserved for manufacturers which name begins with 'A'
'18'H .. '1F'H	Reserved for manufacturers which name begins with 'B'
'20'H .. '27'H	Reserved for manufacturers which name begins with 'C'
'28'H .. '2F'H	Reserved for manufacturers which name begins with 'D'
'30'H .. '37'H	Reserved for manufacturers which name begins with 'E'
'38'H .. '3F'H	Reserved for manufacturers which name begins with 'F'
'40'H	Giesecke & Devrient GmbH
'41'H	GEM plus
'42'H .. '47'H	Reserved for manufacturers which name begins with 'G'
'48'H .. '4F'H	Reserved for manufacturers which name begins with 'H'
'50'H .. '57'H	Reserved for manufacturers which name begins with 'I'
'58'H .. '5F'H	Reserved for manufacturers which name begins with 'J'
'60'H .. '67'H	Reserved for manufacturers which name begins with 'K'
'68'H .. '6F'H	Reserved for manufacturers which name begins with 'L'
'70'H .. '77'H	Reserved for manufacturers which name begins with 'M'
'78'H .. '7F'H	Reserved for manufacturers which name begins with 'N'
'80'H	OSCARD
'81'H .. '87'H	Reserved for manufacturers which name begins with 'O'
'88'H .. '8F'H	Reserved for manufacturers which name begins with 'P'
'90'H .. '97'H	Reserved for manufacturers which name begins with 'Q'
'98'H .. '9F'H	Reserved for manufacturers which name begins with 'R'
'A0'H	SETEC
'A1'H	SIEMENS VDO
'A2'H	STONERIDGE
'A3'H .. 'A7'H	Reserved for manufacturers which name begins with 'S'
'AA'H	TACHOCONTROL
'AB'H .. 'AF'H	Reserved for manufacturers which name begins with 'T'
'B0'H .. 'B7'H	Reserved for manufacturers which name begins with 'U'
'B8'H .. 'BF'H	Reserved for manufacturers which name begins with 'V'
'C0'H .. 'C7'H	Reserved for manufacturers which name begins with 'W'
'C8'H .. 'CF'H	Reserved for manufacturers which name begins with 'X'
'D0'H .. 'D7'H	Reserved for manufacturers which name begins with 'Y'
'D8'H .. 'DF'H	Reserved for manufacturers which name begins with 'Z'

### 2.68. MemberStateCertificate

The certificate of the public key of a Member State issued by the European certification authority.

```
MemberStateCertificate ::= Certificate
```

**2.69. MemberStatePublicKey**

The public key of a Member State.

MemberStatePublicKey ::= PublicKey.

**2.70. Name**

A name.

```
Name ::= SEQUENCE {
    codePage                INTEGER (0..255),
    name                    OCTET STRING (SIZE(35))
}
```

**codePage** specifies the part of the ISO/IEC 8859 used to code the name,

**name** is a name coded in accordance with ISO/IEC 8859-codePage.

**2.71. NationAlpha**

Alphabetic reference to a country, in accordance with the conventional coding of countries on car bumper stickers, and/or as used on internationally harmonised vehicle insurance papers (green card).

NationAlpha ::= IA5String(SIZE(3))

**Value assignment:**

' '	No information available
'A'	Austria
'AL'	Albania
'AND'	Andorra
'ARM'	Armenia
'AZ'	Azerbaijan
'B'	Belgium
'BG'	Bulgaria
'BIH'	Bosnia and Herzegovina
'BY'	Belarus
'CH'	Switzerland
'CY'	Cyprus
'CZ'	Czech Republic
'D'	Germany
'DK'	Denmark
'E'	Spain
'EST'	Estonia
'F'	France
'FIN'	Finland
'FL'	Liechtenstein
'FR'	Faeroe Islands
'UK'	United Kingdom, Alderney, Guernsey, Jersey, Isle of Man, Gibraltar
'GE'	Georgia
'GR'	Greece
'H'	Hungary
'HR'	Croatia
'I'	Italy
'IRL'	Ireland
'IS'	Iceland
'KZ'	Kazakhstan
'L'	Luxembourg
'LT'	Lithuania
'LV'	Latvia
'M'	Malta
'MC'	Monaco

'MD'	Republic of Moldova
'MK'	Macedonia
'N'	Norway
'NL'	The Netherlands
'P'	Portugal
'PL'	Poland
'RO'	Romania
'RSM'	San Marino
'RUS'	Russian Federation
'S'	Sweden
'SK'	Slovakia
'SLO'	Slovenia
'TM'	Turkmenistan
'TR'	Turkey
'UA'	Ukraine
'V'	Vatican City
'YU'	Yugoslavia
'UNK'	Unknown
'EC'	European Community
'EUR'	Rest of Europe
'WLD'	Rest of the world.

### 2.7.2. NationNumeric

Numerical reference to a country.

NationNumeric ::= INTEGER(0..255)

#### Value assignment:

-- No information available	(00) H,
-- Austria	(01) H,
-- Albania	(02) H,
-- Andorra	(03) H,
-- Armenia	(04) H,
-- Azerbaijan	(05) H,
-- Belgium	(06) H,
-- Bulgaria	(07) H,
-- Bosnia and Herzegovina	(08) H,
-- Belarus	(09) H,
-- Switzerland	(0A) H,
-- Cyprus	(0B) H,
-- Czech Republic	(0C) H,
-- Germany	(0D) H,
-- Denmark	(0E) H,
-- Spain	(0F) H,
-- Estonia	(10) H,
-- France	(11) H,
-- Finland	(12) H,
-- Liechtenstein	(13) H,
-- Faeroe Islands	(14) H,
-- United Kingdom	(15) H,
-- Georgia	(16) H,
-- Greece	(17) H,
-- Hungary	(18) H,
-- Croatia	(19) H,
-- Italy	(1A) H,
-- Ireland	(1B) H,
-- Iceland	(1C) H,

-- Kazakhstan	(1D)H,
-- Luxembourg	(1E)H,
-- Lithuania	(1F)H,
-- Latvia	(20)H,
-- Malta	(21)H,
-- Monaco	(22)H,
-- Republic of Moldova	(23)H,
-- Macedonia	(24)H,
-- Norway	(25)H,
-- Netherlands	(26)H,
-- Portugal	(27)H,
-- Poland	(28)H,
-- Romania	(29)H,
-- San Marino	(2A)H,
-- Russian Federation	(2B)H,
-- Sweden	(2C)H,
-- Slovakia	(2D)H,
-- Slovenia	(2E)H,
-- Turkmenistan	(2F)H,
-- Turkey	(30)H,
-- Ukraine	(31)H,
-- Vatican City	(32)H,
-- Yugoslavia	(33)H,
-- RFU	(34..FC)H,
-- European Community	(FD)H,
-- Rest of Europe	(FE)H,
-- Rest of the world	(FF)H

**2.73. NoOfCalibrationRecords**

Number of calibration records, a workshop card can store.

NoOfCalibrationRecords ::= INTEGER(0..255)

**Value assignment:** see paragraph 3.

**2.74. NoOfCalibrationsSinceDownload**

Counter indicating the number of calibrations performed with a workshop card since its last download (requirement 230).

NoOfCalibrationsSinceDownload ::= INTEGER(0..2<sup>16</sup>-1),

**Value assignment:** Not specified further.

**2.75. NoOfCardPlaceRecords**

Number of place records a driver or workshop card can store.

NoOfCardPlaceRecords ::= INTEGER(0..255)

**Value assignment:** see paragraph 3.

**2.76. NoOfCardVehicleRecords**

Number of vehicles used records a driver or workshop card can store.

NoOfCardVehicleRecords ::= INTEGER(0..2<sup>16</sup>-1)

**Value assignment:** see paragraph 3.

**2.77. NoOfCompanyActivityRecords**

Number of company activity records, a company card can store.

NoOfCompanyActivityRecords ::= INTEGER(0..2<sup>16</sup>-1)

**Value assignment:** see paragraph 3.

**2.78. NoOfControlActivityRecords**

Number of control activity records, a control card can store.

NoOfControlActivityRecords ::= INTEGER(0..2<sup>16</sup>-1)

**Value assignment:** see paragraph 3.

**2.79. NoOfEventsPerType**

Number of events per type of event a card can store.

NoOfEventsPerType ::= INTEGER(0..255)

**Value assignment:** see paragraph 3.

**2.80. NoOfFaultsPerType**

Number of faults per type of fault a card can store.

NoOfFaultsPerType ::= INTEGER(0..255)

**Value assignment:** see paragraph 3.

**2.81. OdometerValueMidnight**

The vehicle's odometer value at midnight on a given day (requirement 090).

OdometerValueMidnight ::= OdometerShort

**Value assignment:** not further specified.

**2.82. OdometerShort**

Odometer value of the vehicle in a short form.

OdometerShort ::= INTEGER(0..2<sup>24</sup>-1)

**Value assignment:** Unsigned binary. Value in km in the operating range 0 to 9 999 999 km.

**2.83. OverspeedNumber**

Number of over speeding events since the last over speeding control.

OverspeedNumber ::= INTEGER(0..255)

**Value assignment:** 0 means that no over speeding event has occurred since the last over speeding control, 1 means that one over speeding event has occurred since the last over speeding control ... 255 means that 255 or more over speeding events have occurred since the last over speeding control.

**2.84. PlaceRecord**

Information related to a place where a daily work period begins or ends (requirements 087, 202, 221).

```
PlaceRecord ::= SEQUENCE {
    entryTime                               TimeReal,
    entryTypeDailyWorkPeriod               EntryTypeDailyWorkPeriod,
    dailyWorkPeriodCountry                  NationNumeric,
    dailyWorkPeriodRegion                   RegionNumeric,
    vehicleOdometerValue                     OdometerShort
}
```

**entryTime** is a date and time related to the entry.

**entryTypeDailyWorkPeriod** is the type of entry.

**dailyWorkPeriodCountry** is the country entered.

**dailyWorkPeriodRegion** is the region entered.

**vehicleOdometerValue** is the odometer value at the time of place entry.

**2.85. PreviousVehicleInfo**

Information related to the vehicle previously used by a driver when inserting his card in a vehicle unit (requirement 081).

```
PreviousVehicleInfo ::= SEQUENCE {
    vehicleRegistrationIdentification      VehicleRegistrationIdentification,
    cardWithdrawalTime                    TimeReal
}
```

**vehicleRegistrationIdentification** is the VRN and the registering Member State of the vehicle.

**cardWithdrawalTime** is the card withdrawal date and time.

**2.86. PublicKey**

A public RSA key.

```
PublicKey ::= SEQUENCE {
    rsaKeyModulus                        RSAKeyModulus,
    rsaKeyPublicExponent                 RSAKeyPublicExponent
}
```

**rsaKeyModulus** is the Modulus of the key pair.

**rsaKeyPublicExponent** is the public exponent of the key pair.

**2.87. RegionAlpha**

Alphabetic reference to a region within a specified country.

```
RegionAlpha ::= IA5STRING(SIZE(3))
```

**Value assignment:**

' ' No information available

Spain:

'AN'	Andalucía
'AR'	Aragón
'AST'	Asturias
'C'	Cantabria
'CAT'	Cataluña
'CL'	Castilla-León
'CM'	Castilla-La-Mancha
'CV'	Valencia
'EXT'	Extremadura
'G'	Galicia
'IB'	Baleares
'IC'	Canarias
'LR'	La Rioja
'M'	Madrid
'MU'	Murcia
'NA'	Navarra
'PV'	País Vasco.

**2.88. RegionNumeric**

Numerical reference to a region within a specified country.

```
RegionNumeric ::= OCTET STRING(SIZE(1))
```

**Value assignment:**

'00'H No information available

Spain:

'01'H Andalucía  
 '02'H Aragón  
 '03'H Asturias  
 '04'H Cantabria  
 '05'H Cataluña  
 '06'H Castilla-León  
 '07'H Castilla-La-Mancha  
 '08'H Valencia  
 '09'H Extremadura  
 '0A'H Galicia  
 '0B'H Baleares  
 '0C'H Canarias  
 '0D'H La Rioja  
 '0E'H Madrid  
 '0F'H Murcia  
 '10'H Navarra  
 '11'H País Vasco.

**2.89. RSAKeyModulus**

The modulus of a RSA key pair.

RSAKeyModulus ::= OCTET STRING (SIZE(128))

**Value assignment:** Unspecified.

**2.90. RSAKeyPrivateExponent**

The private exponent of a RSA key pair.

RSAKeyPrivateExponent ::= OCTET STRING (SIZE(128))

**Value assignment:** Unspecified.

**2.91. RSAKeyPublicExponent**

The public exponent of a RSA key pair.

RSAKeyPublicExponent ::= OCTET STRING (SIZE(8))

**Value assignment:** Unspecified.

**2.92. SensorApprovalNumber**

Type approval number of the sensor.

SensorApprovalNumber ::= IA5String(SIZE(8))

**Value assignment:** Unspecified.

**2.93. SensorIdentification**

Information, stored in a motion sensor, related to the identification of the motion sensor (requirement 077).

```
SensorIdentification ::= SEQUENCE {
    sensorSerialNumber          SensorSerialNumber,
    sensorApprovalNumber       SensorApprovalNumber,
    sensorSCIdentifier          SensorSCIdentifier,
    sensorOSIdentifier         SensorOSIdentifier
}
```



**sensorSerialNumber** is the extended serial number of the motion sensor (includes part number and manufacturer code).

**sensorApprovalNumber** is the approval number of the motion sensor.

**sensorSCIdentifier** is the identifier of the security component of the motion sensor.

**sensorOSIdentifier** is the identifier of the operating system of the motion sensor.

#### 2.94. SensorInstallation

Information, stored in a motion sensor, related to the installation of the motion sensor (requirement 099).

```
SensorInstallation ::= SEQUENCE {
    sensorPairingDateFirst          SensorPairingDate,
    firstVuApprovalNumber          VuApprovalNumber,
    firstVuSerialNumber            VuSerialNumber,
    sensorPairingDateCurrent       SensorPairingDate,
    currentVuApprovalNumber        VuApprovalNumber,
    currentVUSerialNumber          VuSerialNumber
}
```

**sensorPairingDateFirst** is the date of the first pairing of the motion sensor with a vehicle unit.

**firstVuApprovalNumber** is the approval number of the first vehicle unit paired with the motion sensor.

**firstVuSerialNumber** is the serial number of the first vehicle unit paired with the motion sensor.

**sensorPairingDateCurrent** is the date of the current pairing of the motion sensor with the vehicle unit.

**currentVuApprovalNumber** is the approval number of the vehicle unit currently paired with the motion sensor.

**currentVUSerialNumber** is the serial number of the vehicle unit currently paired with the motion sensor.

#### 2.95. SensorInstallationSecData

Information, stored in a workshop card, related to the security data needed for pairing motion sensors to vehicle units (requirement 214).

```
SensorInstallationSecData ::= TDesSessionKey
```

**Value assignment:** in accordance with ISO 16844-3.

#### 2.96. SensorOSIdentifier

Identifier of the operating system of the motion sensor.

```
SensorOSIdentifier ::= IA5String(SIZE(2))
```

**Value assignment:** manufacturer specific.

#### 2.97. SensorPaired

Information, stored in a vehicle unit, related to the identification of the motion sensor paired with the vehicle unit (requirement 079).

```
SensorPaired ::= SEQUENCE {
    sensorSerialNumber          SensorSerialNumber,
    sensorApprovalNumber        SensorApprovalNumber,
    sensorPairingDateFirst      SensorPairingDate
}
```

**sensorSerialNumber** is the serial number of the motion sensor currently paired with the vehicle unit.

**sensorApprovalNumber** is the approval number of the motion sensor currently paired with the vehicle unit.

**sensorPairingDateFirst** is the date of the first pairing with a vehicle unit of the motion sensor currently paired with the vehicle unit.

#### 2.98. **SensorPairingDate**

Date of a pairing of the motion sensor with a vehicle unit.

`SensorPairingDate ::= TimeReal`

**Value assignment:** Unspecified.

#### 2.99. **SensorSerialNumber**

Serial number of the motion sensor.

`SensorSerialNumber ::= ExtendedSerialNumber:`

#### 2.100. **SensorSCIdentifier**

Identifier of the security component of the motion sensor.

`SensorSCIdentifier ::= IA5String(SIZE(8))`

**Value assignment:** component manufacturer specific.

#### 2.101. **Signature**

A digital signature.

`Signature ::= OCTET STRING (SIZE(128))`

**Value assignment:** in accordance with Appendix 11, "Common security mechanisms".

#### 2.102. **SimilarEventsNumber**

The number of similar events for one given day (requirement 094).

`SimilarEventsNumber ::= INTEGER(0..255)`

**Value assignment:** 0 is not used, 1 means that only one event of that type have occurred and have been stored on that day, 2 means that 2 events of that type have occurred on that day (one only has been stored), ... 255 means that 255 or more events of that type have occurred on that day.

#### 2.103. **SpecificConditionType**

Code identifying a specific condition (requirements 050b, 105a, 212a and 230a).

`SpecificConditionType ::= INTEGER(0..255)`

**Value assignment:**

'00'H	RFU
'01'H	Out of scope — Begin
'02'H	Out of scope — End
'03'H	Ferry/Train crossing
'04'H .. 'FF'H	RFU.

#### 2.104. **SpecificConditionRecord**

Information, stored in a driver card, a workshop card or a vehicle unit, related to a specific condition (requirements 105a, 212a and 230a).

```
SpecificConditionRecord ::= SEQUENCE {
    entryTime                TimeReal,
    specificConditionType    SpecificConditionType
}
```

**entryTime** is the date and time of the entry.

**specificConditionType** is the code identifying the specific condition.

#### 2.105. Speed

Speed of the vehicle (km/h).

```
Speed ::= INTEGER(0..255)
```

**Value assignment:** kilometre per hour in the operational range 0 to 220 km/h.

#### 2.106. SpeedAuthorised

Maximum authorised Speed of the vehicle (definition bb).

```
SpeedAuthorised ::= Speed.
```

#### 2.107. SpeedAverage

Average speed in a previously defined duration (km/h).

```
SpeedAverage ::= Speed.
```

#### 2.108. SpeedMax

Maximum speed measured in a previously defined duration.

```
SpeedMax ::= Speed.
```

#### 2.109. TDesSessionKey

A triple DES session key.

```
TDesSessionKey ::= SEQUENCE {
    tDesKeyA                OCTET STRING (SIZE(8))
    tDesKeyB                OCTET STRING (SIZE(8))
}
```

**Value assignment:** not further specified.

#### 2.110. TimeReal

Code for a combined date and time field, where the date and time are expressed as seconds past 00h.00m.00s. on 1 January 1970 GMT.

```
TimeReal{INTEGER:TimeRealRange} ::= INTEGER(0..TimeRealRange)
```

**Value assignment — Octet Aligned:** Number of seconds since midnight 1 January 1970 GMT.

The max possible date/time is in the year 2106.

#### 2.111. TyreSize

Designation of tyre dimensions.

```
TyreSize ::= IA5String(SIZE(15))
```

**Value assignment:** in accordance with Directive 92/23 (EEC) 31.3.1992, OJ L 129, p. 95.

**2.112. VehicleIdentificationNumber**

Vehicle Identification Number (VIN) referring to the vehicle as a whole, normally chassis serial number or frame number.

```
VehicleIdentificationNumber ::= IA5String(SIZE(17))
```

**Value assignment:** As defined in ISO 3779.

**2.113. VehicleRegistrationIdentification**

Identification of a vehicle, unique for Europe (VRN and Member State).

```
VehicleRegistrationIdentification ::= SEQUENCE {
    vehicleRegistrationNation      NationNumeric,
    vehicleRegistrationNumber      VehicleRegistrationNumber
}
```

**vehicleRegistrationNation** is the nation where the vehicle is registered.

**vehicleRegistrationNumber** is the registration number of the vehicle (VRN).

**2.114. VehicleRegistrationNumber**

Registration number of the vehicle (VRN). The registration number is assigned by the vehicle licensing authority.

```
VehicleRegistrationNumber ::= SEQUENCE {
    codePage                      INTEGER (0..255),
    vehicleRegNumber              OCTET STRING (SIZE(13))
}
```

**codePage** specifies the part of the ISO/IEC 8859 used to code the vehicleRegNumber,

**vehicleRegNumber** is a VRN coded in accordance with ISO/IEC 8859-codePage.

**Value assignment:** Country specific.

**2.115. VuActivityDailyData**

Information, stored in a VU, related to changes of activity and/or changes of driving status and/or changes of card status for a given calendar day (requirement 084) and to slots status at 00.00 that day.

```
VuActivityDailyData ::= SEQUENCE {
    noOfActivityChanges           INTEGER SIZE (0..1440),
    activityChangeInfos           SET SIZE (noOfActivityChanges) OF
    ActivityChangeInfo
}
```

**noOfActivityChanges** is the number of ActivityChangeInfo words in the activityChangeInfos set.

**activityChangeInfos** is the set of ActivityChangeInfo words stored in the VU for the day. It always includes two ActivityChangeInfo words giving the status of the two slots at 00.00 that day.

**2.116. VuApprovalNumber**

Type approval number of the vehicle unit.

```
VuApprovalNumber ::= IA5String(SIZE(8))
```

**Value assignment:** Unspecified.

**2.117. VuCalibrationData**

Information, stored in a vehicle unit, related to the calibrations of the recording equipment (requirement 098).

```
VuCalibrationData ::= SEQUENCE {
    noOfVuCalibrationRecords      INTEGER(0..255),
    vuCalibrationRecords          SET SIZE (noOfVuCalibrationRecords) OF
    VuCalibrationRecord
}
```

**noOfVuCalibrationRecords** is the number of records contained in the vuCalibrationRecords set.

**vuCalibrationRecords** is the set of calibration records.

### 2.118. VuCalibrationRecord

Information, stored in a vehicle unit, related a calibration of the recording equipment (requirement 098).

```
VuCalibrationRecord ::= SEQUENCE {
    calibrationPurpose           CalibrationPurpose,
    workshopName                 Name,
    workshopAddress              Address,
    workshopCardNumber          FullCardNumber,
    workshopCardExpiryDate      TimeReal,
    vehicleIdentificationNumber  VehicleIdentificationNumber,
    vehicleRegistrationIdentification  VehicleRegistrationIdentification,
    wVehicleCharacteristicConstant  W-VehicleCharacteristicConstant,
    kConstantOfRecordingEquipment  K-ConstantOfRecordingEquipment,
    lTyreCircumference          L-TyreCircumference,
    tyreSize                     TyreSize,
    authorisedSpeed              SpeedAuthorised,
    oldOdometerValue            OdometerShort,
    newOdometerValue            OdometerShort,
    oldTimeValue                TimeReal,
    newTimeValue                TimeReal,
    nextCalibrationDate         TimeReal
}
```

**calibrationPurpose** is the purpose of the calibration.

**workshopName**, **workshopAddress** are the workshop name and address.

**workshopCardNumber** identifies the workshop card used during the calibration.

**workshopCardExpiryDate** is the card expiry date.

**vehicleIdentificationNumber** is the VIN.

**vehicleRegistrationIdentification** contains the VRN and registering Member State.

**wVehicleCharacteristicConstant** is the characteristic coefficient of the vehicle.

**kConstantOfRecordingEquipment** is the constant of the recording equipment.

**lTyreCircumference** is the effective circumference of the wheel tyres.

**tyreSize** is the designation of the dimension of the tyres mounted on the vehicle.

**authorisedSpeed** is the authorised speed of the vehicle.

**oldOdometerValue**, **newOdometerValue** are the old and new values of the odometer.

**oldTimeValue**, **newTimeValue** are the old and new values of date and time.

**nextCalibrationDate** is the date of the next calibration of the type specified in CalibrationPurpose to be carried out by the authorised inspection authority.

### 2.119. VuCardIWDData

Information, stored in a vehicle unit, related to insertion and withdrawal cycles of driver cards or of workshop cards in the vehicle unit (requirement 081).

```
VuCardIWDData ::= SEQUENCE {
    noOfIWRecords               INTEGER(0..216-1),
    vuCardIWRecords SET        SIZE(noOfIWRecords) OF
                                VuCardIWRecord
}
```

**noOfIWRecords** is the number of records in the set `vuCardIWRecords`.

**vuCardIWRecords** is a set of records related to card insertion withdrawal cycles.

#### 2.120. **VuCardIWRecord**

Information, stored in a vehicle unit, related to an insertion and withdrawal cycle of a driver card or of a workshop card in the vehicle unit (requirement 081).

```
VuCardIWRecord ::= SEQUENCE {
    cardHolderName           HolderName,
    fullCardNumber           FullCardNumber,
    cardExpiryDate          TimeReal,
    cardInsertionTime        TimeReal,
    vehicleOdometerValueAtInsertion OdometerShort,
    cardSlotNumber           CardsSlotNumber,
    cardWithdrawalTime       TimeReal,
    vehicleOdometerValueAtWithdrawal OdometerShort,
    previousVehicleInfo      PreviousVehicleInfo
    manualInputFlag          ManualInputFlag
}
```

**cardHolderName** is the driver or workshop card holder's surname and first names as stored in the card.

**fullCardNumber** is the type of card, its issuing Member State and its card number as stored in the card.

**cardExpiryDate** is the card's expiry date as stored in the card.

**cardInsertionTime** is the insertion date and time.

**vehicleOdometerValueAtInsertion** is the vehicle odometer value at card insertion.

**cardSlotNumber** is the slot in which the card is inserted.

**cardWithdrawalTime** is the withdrawal date and time.

**vehicleOdometerValueAtWithdrawal** is the vehicle odometer value at card withdrawal.

**previousVehicleInfo** contains information about the previous vehicle used by the driver, as stored in the card.

**manualInputFlag** is a flag identifying if the cardholder has manually entered driver activities at card insertion.

#### 2.121. **VuCertificate**

Certificate of the public key of a vehicle unit.

```
VuCertificate ::= Certificate
```

#### 2.122. **VuCompanyLocksData**

Information, stored in a vehicle unit, related to company locks (requirement 104).

```
VuCompanyLocksData ::= SEQUENCE {
    noOfLocks                INTEGER(0..20),
    vuCompanyLocksRecords    SET SIZE(noOfLocks) OF
                             VuCompanyLocksRecord
}
```

**noOfLocks** is the number of locks listed in `vuCompanyLocksRecords`.

**vuCompanyLocksRecords** is the set of company locks records.

**2.123. VuCompanyLocksRecord**

Information, stored in a vehicle unit, related to one company lock (requirement 104).

```
VuCompanyLocksRecord ::= SEQUENCE {
    lockInTime                TimeReal,
    lockOutTime               TimeReal,
    companyName               Name,
    companyAddress            Address,
    companyCardNumber         FullCardNumber
}
```

**lockInTime**, **lockOutTime** are the date and time of lock-in and lock-out.

**companyName**, **companyAddress** are the company name and address related with the lock-in.

**companyCardNumber** identifies the card used at lock-in.

**2.124. VuControlActivityData**

Information, stored in a vehicle unit, related to controls performed using this VU (requirement 102).

```
VuControlActivityData ::= SEQUENCE {
    noOfControls               INTEGER(0..20),
    vuControlActivityRecords   SET SIZE(noOfControls) OF
                               VuControlActivityRecord
}
```

**noOfControls** is the number of controls listed in **vuControlActivityRecords**.

**vuControlActivityRecords** is the set of control activity records.

**2.125. VuControlActivityRecord**

Information, stored in a vehicle unit, related to a control performed using this VU (requirement 102).

```
VuControlActivityRecord ::= SEQUENCE {
    controlType               ControlType,
    controlTime               TimeReal,
    controlCardNumber         FullCardNumber,
    downloadPeriodBeginTime   TimeReal,
    downloadPeriodEndTime     TimeReal
}
```

**controlType** is the type of the control.

**controlTime** is the date and time of the control.

**ControlCardNumber** identifies the control card used for the control.

**downloadPeriodBeginTime** is the begin time of the downloaded period, in case of downloading.

**downloadPeriodEndTime** is the end time of the downloaded period, in case of downloading.

**2.126. VuDataBlockCounter**

Counter, stored in a card, identifying sequentially the insertion withdrawal cycles of the card in vehicle units.

```
VuDataBlockCounter ::= BCDString(SIZE(2))
```

**Value assignment:** Consecutive Number with max, value 9 999, starting again with 0.

**2.127. VuDetailedSpeedBlock**

Information, stored in a vehicle unit, related to the vehicle's detailed speed for a minute during which the vehicle has been moving (requirement 093).

```
VuDetailedSpeedBlock ::= SEQUENCE {
    speedBlockBeginDate          TimeReal,
    speedsPerSecond              SEQUENCE SIZE (60) OF Speed
}
```

**speedBlockBeginDate** is the date and time of the first speed value within the block.

**speedsPerSecond** is the chronological sequence of measured speeds every seconds for the minute starting at speedBlockBeginDate (included).

#### 2.128. VuDetailedSpeedData

Information, stored in a vehicle unit, related to the detailed speed of the vehicle.

```
VuDetailedSpeedData ::= SEQUENCE
    noOfSpeedBlocks              INTEGER (0..216-1),
    vuDetailedSpeedBlocks        SET SIZE (noOfSpeedBlocks) OF
                                VuDetailedSpeedBlock
}
```

**noOfSpeedBlocks** is the number of speed blocks in the vuDetailedSpeedBlocks set.

**vuDetailedSpeedBlocks** is the set of detailed speed blocks.

#### 2.129. VuDownloadablePeriod

Oldest and latest dates for which a vehicle unit holds data related to drivers activities (requirements 081, 084 or 087).

```
VuDownloadablePeriod ::= SEQUENCE {
    minDownloadableTime          TimeReal
    maxDownloadableTime          TimeReal
}
```

**minDownloadableTime** is the oldest card insertion or activity change or place entry date and time stored in the VU.

**maxDownloadableTime** is the latest card withdrawal or activity change or place entry date and time stored in the VU.

#### 2.130. VuDownloadActivityData

Information, stored in a vehicle unit, related to its last download (requirement 105).

```
VuDownloadActivityData ::= SEQUENCE {
    downloadingTime              TimeReal,
    fullCardNumber                FullCardNumber,
    companyOrWorkshopName        Name
}
```

**downloadingTime** is the date and time of downloading.

**fullCardNumber** identifies the card used to authorise the download.

**companyOrWorkshopName** is the company or workshop name.

#### 2.131. VuEventData

Information, stored in a vehicle unit, related to events (requirement 094 except over speeding event).

```
VuEventData ::= SEQUENCE {
    noOfVuEvents                  INTEGER (0..255),
    vuEventRecords                SET SIZE (noOfVuEvents) OF VuEventRecord
}
```

**noOfVuEvents** is the number of events listed in the vuEventRecords set.

**vuEventRecords** is a set of events records.



**2.132. VuEventRecord**

Information, stored in a vehicle unit, related to an event (requirement 094 except over speeding event).

```
VuEventRecord ::= SEQUENCE {
    eventType                EventFaultType,
    eventRecordPurpose       EventFaultRecordPurpose,
    eventBeginTime           TimeReal,
    eventEndTime             TimeReal,
    cardNumberDriverSlotBegin FullCardNumber,
    cardNumberCodriverSlotBegin FullCardNumber,
    cardNumberDriverSlotEnd  FullCardNumber,
    cardNumberCodriverSlotEnd FullCardNumber,
    similarEventsNumber      SimilarEventsNumber
}
```

**eventType** is the type of the event.

**eventRecordPurpose** is the purpose for which this event has been recorded.

**eventBeginTime** is the date and time of beginning of event.

**eventEndTime** is the date and time of end of event.

**cardNumberDriverSlotBegin** identifies the card inserted in the driver slot at the beginning of the event.

**cardNumberCodriverSlotBegin** identifies the card inserted in the co-driver slot at the beginning of the event.

**cardNumberDriverSlotEnd** identifies the card inserted in the driver slot at the end of the event.

**cardNumberCodriverSlotEnd** identifies the card inserted in the co-driver slot at the end of the event.

**similarEventsNumber** is the number of similar events that day.

This sequence can be used for all events other than over speeding events.

**2.133. VuFaultData**

Information, stored in a vehicle unit, related to faults (requirement 096).

```
VuFaultData ::= SEQUENCE {
    noOfVuFaults                INTEGER(0..255),
    vuFaultRecords SET          SIZE(noOfVuFaults) OF VuFaultRecord
}
```

**noOfVuFaults** is the number of faults listed in the vuFaultRecords set.

**vuFaultRecords** is a set of faults records.

**2.134. VuFaultRecord**

Information, stored in a vehicle unit, related to a fault (requirement 096).

```
VuFaultRecord ::= SEQUENCE {
    faultType                EventFaultType,
    faultRecordPurpose       EventFaultRecordPurpose,
    faultBeginTime           TimeReal,
    faultEndTime             TimeReal,
    cardNumberDriverSlotBegin FullCardNumber,
    cardNumberCodriverSlotBegin FullCardNumber,
    cardNumberDriverSlotEnd  FullCardNumber,
    cardNumberCodriverSlotEnd FullCardNumber
}
```

**faultType** is the type of recording equipment fault.

**faultRecordPurpose** is the purpose for which this fault has been recorded.

**faultBeginTime** is the date and time of beginning of fault.

**faultEndTime** is the date and time of end of fault.

**cardNumberDriverSlotBegin** identifies the card inserted in the driver slot at the beginning of the fault.

**cardNumberCodriverSlotBegin** identifies the card inserted in the co-driver slot at the beginning of the fault.

**cardNumberDriverSlotEnd** identifies the card inserted in the driver slot at the end of the fault.

**cardNumberCodriverSlotEnd** identifies the card inserted in the co-driver slot at the end of the fault.

#### 2.135. **VuIdentification**

Information, stored in a vehicle unit, related to the identification of the vehicle unit (requirement 075).

```
VuIdentification ::= SEQUENCE {
    vuManufacturerName          VuManufacturerName,
    vuManufacturerAddress      VuManufacturerAddress,
    vuPartNumber               VuPartNumber,
    vuSerialNumber             VuSerialNumber,
    vuSoftwareIdentification   VuSoftwareIdentification,
    vuManufacturingDate        VuManufacturingDate,
    vuApprovalNumber           VuApprovalNumber
}
```

**vuManufacturerName** is the name of the manufacturer of the vehicle unit.

**vuManufacturerAddress** is the address of the manufacturer of the vehicle unit.

**vuPartNumber** is the part number of the vehicle unit.

**vuSerialNumber** is the serial number of the vehicle unit.

**vuSoftwareIdentification** identifies the software implemented in the vehicle unit.

**vuManufacturingDate** is the manufacturing date of the vehicle unit.

**vuApprovalNumber** is the type approval number of the vehicle unit.

#### 2.136. **VuManufacturerAddress**

Address of the manufacturer of the vehicle unit.

```
VuManufacturerAddress ::= Address
```

**Value assignment:** Unspecified.

#### 2.137. **VuManufacturerName**

Name of the manufacturer of the vehicle unit.

```
VuManufacturerName ::= Name
```

**Value assignment:** Unspecified.

#### 2.138. **VuManufacturingDate**

Date of manufacture of the vehicle unit.

```
VuManufacturingDate ::= TimeReal
```

**Value assignment:** Unspecified.

**2.139. VuOverSpeedingControlData**

Information, stored in a vehicle unit, related to over speeding events since the last over speeding control (requirement 095).

```
VuOverSpeedingControlData ::= SEQUENCE {
    lastOverspeedControlTime      TimeReal,
    firstOverspeedSince           TimeReal,
    numberOfOverspeedSince        OverspeedNumber
}
```

**lastOverspeedControlTime** is the date and time of the last over speeding control.

**firstOverspeedSince** is the date and time of the first over speeding following this over speeding control.

**numberOfOverspeedSince** is the number of over speeding events since the last over speeding control.

**2.140. VuOverSpeedingEventData**

Information, stored in a vehicle unit, related to over speeding events (requirement 094).

```
VuOverSpeedingEventData ::= SEQUENCE {
    noOfVuOverSpeedingEvents      INTEGER(0..255),
    vuOverSpeedingEventRecords    SET SIZE(noOfVuOverSpeedingEvents) OF
                                   VuOverSpeedingEventRecord
}
```

**noOfVuOverSpeedingEvents** is the number of events listed in the vuOverSpeedingEventRecords set.

**vuOverSpeedingEventRecords** is a set of over speeding events records.

**2.141. VuOverSpeedingEventRecord**

Information, stored in a vehicle unit, related to over speeding events (requirement 094).

```
VuOverSpeedingEventRecord ::= SEQUENCE {
    eventType                      EventFaultType,
    eventRecordPurpose             EventFaultRecordPurpose,
    eventBeginTime                 TimeReal,
    eventEndTime                   TimeReal,
    maxSpeedValue                  SpeedMax,
    averageSpeedValue              SpeedAverage,
    cardNumberDriverSlotBegin      FullCardNumber,
    similarEventsNumber            SimilarEventsNumber
}
```

**eventType** is the type of the event.

**eventRecordPurpose** is the purpose for which this event has been recorded.

**eventBeginTime** is the date and time of beginning of event.

**eventEndTime** is the date and time of end of event.

**maxSpeedValue** is the maximum speed measured during the event.

**averageSpeedValue** is the arithmetic average speed measured during the event.

**cardNumberDriverSlotBegin** identifies the card inserted in the driver slot at the beginning of the event.

**similarEventsNumber** is the number of similar events that day.

**2.142. VuPartNumber**

Part number of the vehicle unit.

```
VuPartNumber ::= IA5String(SIZE(16))
```

**Value assignment:** VU manufacturer specific.

**2.143. VuPlaceDailyWorkPeriodData**

Information, stored in a vehicle unit, related to places where drivers begin or end a daily work periods (requirement 087).

```
VuPlaceDailyWorkPeriodData ::= SEQUENCE {
    noOfPlaceRecords                INTEGER(0..255),
    vuPlaceDailyWorkPeriodRecords   SET SIZE(noOfPlaceRecords) OF
    VuPlaceDailyWorkPeriodRecord
}
```

**noOfPlaceRecords** is the number of records listed in the vuPlaceDailyWorkPeriodRecords set.

**vuPlaceDailyWorkPeriodRecords** is a set of place related records.

**2.144. VuPlaceDailyWorkPeriodRecord**

Information, stored in a vehicle unit, related to a place where a driver begins or ends a daily work period (requirement 087).

```
VuPlaceDailyWorkPeriodRecord ::= SEQUENCE {
    fullCardNumber                  FullCardNumber,
    placeRecord                     PlaceRecord
}
```

**fullCardNumber** is the driver's card type, card issuing Member State and card number.

**placeRecord** contains the information related to the place entered.

**2.145. VuPrivateKey**

The private key of a vehicle unit.

```
VuPrivateKey ::= RSAKeyPrivateExponent
```

**2.146. VuPublicKey**

The public key of a vehicle unit.

```
VuPublicKey ::= PublicKey
```

**2.147. VuSerialNumber**

Serial number of the vehicle unit (requirement 075).

```
VuSerialNumber ::= ExtendedSerialNumber
```

**2.148. VuSoftInstallationDate**

Date of installation of the vehicle unit software version.

```
VuSoftInstallationDate ::= TimeReal
```

**Value assignment:** Unspecified.

**2.149. VuSoftwareIdentification**

Information, stored in a vehicle unit, related to the software installed.

```
VuSoftwareIdentification ::= SEQUENCE {
    vuSoftwareVersion                VuSoftwareVersion,
    vuSoftInstallationDate           VuSoftInstallationDate
}
```

**vuSoftwareVersion** is the software version number of the Vehicle Unit.

**vuSoftInstallationDate** is the software version installation date.

**2.150. VuSoftwareVersion**

Software version number of the vehicle unit.

```
VuSoftwareVersion ::= IA5String(SIZE(4))
```

**Value assignment:** Unspecified.

**2.151. VuSpecificConditionData**

Information, stored in a vehicle unit, related to specific conditions.

```
VuSpecificConditionData ::= SEQUENCE {
    noOfSpecificConditionRecords          INTEGER(0..216-1)
    specificConditionRecords              SET SIZE (noOfSpecificConditionRecords) OF
                                          SpecificConditionRecord
}
```

**noOfSpecificConditionRecords** is the number of records listed in the specificConditionRecords set.

**specificConditionRecords** is a set of specific conditions related records.

**2.152. VuTimeAdjustmentData**

Information, stored in a vehicle unit, related to time adjustments performed outside the frame of a regular calibration (requirement 101).

```
VuTimeAdjustmentData ::= SEQUENCE {
    noOfVuTimeAdjRecords                 INTEGER(0..6),
    vuTimeAdjustmentRecords              SET SIZE (noOfVuTimeAdjRecords) OF
                                          VuTimeAdjustmentRecords
}
```

**noOfVuTimeAdjRecords** is the number of records in vuTimeAdjustmentRecords.

**vuTimeAdjustmentRecords** is a set of time adjustment records.

**2.153. VuTimeAdjustmentRecord**

Information, stored in a vehicle unit, related to a time adjustment performed outside the frame of a regular calibration (requirement 101).

```
VuTimeAdjustmentRecord ::= SEQUENCE {
    oldTimeValue                         TimeReal,
    oldTimeValue                         TimeReal,
    newTimeValue                         TimeReal,
    workshopName                         Name,
    workshopAddress                      Address,
    workshopCardNumber                  FullCardNumber
}
```

**oldTimeValue, newTimeValue** are the old and new values of date and time.

**workshopName, workshopAddress** are the workshop name and address.

**workshopCardNumber** identifies the workshop card used to perform the time adjustment.

**2.154. W-VehicleCharacteristicConstant**

Characteristic coefficient of the vehicle (definition k)).

```
W-VehicleCharacteristicConstant ::= INTEGER(0..216-1)
```

**Value assignment:** Impulses per kilometre in the operating range 0 to 64 255 pulses/km.

### 2.155. WorkshopCardApplicationIdentification

Information, stored in a workshop card related to the identification of the application of the card (requirement 190).

```
WorkshopCardApplicationIdentification ::= SEQUENCE {
    typeOfTachographCardId      EquipmentType,
    cardStructureVersion         CardStructureVersion,
    noOfEventsPerType           NoOfEventsPerType,
    noOfFaultsPerType           NoOfFaultsPerType,
    activityStructureLength      CardActivityLengthRange,
    noOfCardVehicleRecords      NoOfCardVehicleRecords,
    noOfCardPlaceRecords        NoOfCardPlaceRecords,
    noOfCalibrationRecords       NoOfCalibrationRecords
}
```

**typeOfTachographCardId** is specifying the implemented type of card.

**cardStructureVersion** is specifying the the version of the structure that is implemented in the card.

**noOfEventsPerType** is the number of events per type of event the card can record.

**noOfFaultsPerType** is the number of faults per type of fault the card can record.

**activityStructureLength** indicates the number of bytes available for storing activity records.

**noOfCardVehicleRecords** is the number of vehicle records the card can contain.

**noOfCardPlaceRecords** is the number of places the card can record.

**noOfCalibrationRecords** is the number of calibration records the card can store.

### 2.156. WorkshopCardCalibrationData

Information, stored in a workshop card, related to workshop activity performed with the card (requirements 227 and 229).

```
WorkshopCardCalibrationData ::= SEQUENCE {
    calibrationTotalNumber      INTEGER(0..216-1),
    calibrationPointerNewestRecord  INTEGER(0..NoOfCalibrationRecords-1),
    calibrationRecords           SET SIZE (NoOfCalibrationRecords) OF
                                WorkshopCardCalibrationRecord
}
```

**calibrationTotalNumber** is the total number of calibrations performed with the card.

**calibrationPointerNewestRecord** is the index of the last updated calibration record.

**Value assignment:** Number corresponding to the numerator of the calibration record, beginning with "0" for the first occurrence of the calibration records in the structure.

**calibrationRecords** is the set of records containing calibration and/or time adjustment information.

### 2.157. WorkshopCardCalibrationRecord

Information, stored in a workshop card, related to a calibration performed with the card (requirement 227).

```
WorkshopCardCalibrationRecord ::= SEQUENCE {
    calibrationPurpose          CalibrationPurpose,
    vehicleIdentificationNumber VehicleIdentificationNumber,
    vehicleRegistration         VehicleRegistrationIdentification,
    wVehicleCharacteristicConstant W-VehicleCharacteristicConstant,
    kConstantOfRecordingEquipment K-ConstantOfRecordingEquipment,
    lTyreCircumference         L-TyreCircumference,
    tyreSize                    TyreSize,
}
```

authorisedSpeed	SpeedAuthorised,
oldOdometerValue	OdometerShort,
newOdometerValue	OdometerShort,
oldTimeValue	TimeReal,
newTimeValue	TimeReal,
nextCalibrationDate	TimeReal,
vuPartNumber	VuPartNumber,
vuSerialNumber	VuSerialNumber,
sensorSerialNumber	SensorSerialNumber

}

**calibrationPurpose** is the purpose of the calibration.

**vehicleIdentificationNumber** is the VIN.

**vehicleRegistration** contains the VRN and registering Member State.

**wVehicleCharacteristicConstant** is the characteristic coefficient of the vehicle.

**kConstantOfRecordingEquipment** is the constant of the recording equipment.

**ITyreCircumference** is the effective circumference of the wheel tyres.

**tyreSize** is the designation of the dimensions of the tyres mounted on the vehicle.

**authorisedSpeed** is the maximum authorised speed of the vehicle.

**oldOdometerValue**, **newOdometerValue** are the old and new values of the odometer.

**oldTimeValue**, **newTimeValue** are the old and new values of date and time.

**nextCalibrationDate** is the date of the next calibration of the type specified in CalibrationPurpose to be carried out by the authorised inspection authority.

**vuPartNumber**, **vuSerialNumber** and **sensorSerialNumber** are the data elements for recording equipment identification.

#### 2.158. WorkshopCardHolderIdentification

Information, stored in a workshop card, related to the identification of the cardholder (requirement 216).

```
WorkshopCardHolderIdentification ::= SEQUENCE {
    workshopName          Name,
    workshopAddress       Address,
    cardHolderName        HolderName,
    cardHolderPreferredLanguage Language
}
```

**workshopName** is name of the workshop of the card holder.

**workshopAddress** is the address of the workshop of the card holder.

**cardHolderName** is the name and first name(s) of the holder (e.g. the name of the mechanic).

**cardHolderPreferredLanguage** is the preferred language of the card holder.

#### 2.159. WorkshopCardPIN

Personal identification number of the Workshop Card (requirement 213).

```
WorkshopCardPIN ::= IA5String(SIZE(8))
```

**Value assignment:** The PIN known to the cardholder, right padded with "FF" bytes up to 8 bytes.

### 3. VALUE AND SIZE RANGE DEFINITIONS

Definition of variable values used for definitions in paragraph 2.

TimeRealRange ::=  $2^{32}-1$

#### 3.1. Definitions for the Driver Card:

Name of the variable value	Minimum	Maximum
CardActivityLengthRange	5 544 bytes (28 days 93 activity changes per day)	13 776 bytes (28 days 240 activity changes per day)
NoOfCardPlaceRecords	84	112
NoOfCardVehicleRecords	84	200
NoOfEventsPerType	6	12
NoOfFaultsPerType	12	24

#### 3.2. Definitions for the Workshop Card:

Name of the variable value	Minimum	Maximum
CardActivityLengthRange	198 bytes (1 day 93 activity changes)	492 bytes (1 day 240 activity changes)
NoOfCardPlaceRecords	6	8
NoOfCardVehicleRecords	4	8
NoOfEventsPerType	3	3
NoOfFaultsPerType	6	6
NoOfCalibrationRecords	88	255

#### 3.3. Definitions for the Control Card:

Name of the variable value	Minimum	Maximum
NoOfControlActivityRecords	230	520

#### 3.4. Definitions for the Company Card:

Name of the variable value	Minimum	Maximum
NoOfCompanyActivityRecords	230	520

### 4. CHARACTER SETS

IA5Strings use the ASCII characters as defined by ISO/IEC 8824-1. For readability and for easy referencing the value assignment is given below. The ISO/IEC 8824-1 supersedes this informative note in case of discrepancy.

! " # \$ % & ' ( ) \* + , - . / 0 1 2 3 4 5 6 7 8 9 : ; < = > ?

@ A B C D E F G H I J K L M N O P Q R S T U V W X Y Z [ \ ] ^ \_

` a b c d e f g h i j k l m n o p q r s t u v w x y z { | } ~

Other character strings (Address, Name, VehicleRegistrationNumber) use, in addition, the characters defined by the codes 192 to 255 of ISO/IEC 8859-1 (Latin1 character set) or ISO/IEC 8859-7 (Greek character set).

### 5. ENCODING

When encoded with ASN.1 encoding rules, all data types defined shall be encoded according to ISO/IEC 8825-2, aligned variant.



## Appendix 2

## TACHOGRAPH CARDS SPECIFICATION

## Contents

1.	Introduction .....	99
1.1.	Abbreviations .....	99
1.2.	References .....	100
2.	Electrical and physical characteristics .....	100
2.1.	Supply voltage and current consumption .....	100
2.2.	Programming voltage $V_{pp}$ .....	101
2.3.	Clock generation and frequency .....	101
2.4.	I/O contact .....	101
2.5.	States of the card .....	101
3.	Hardware and communication .....	101
3.1.	Introduction .....	101
3.2.	Transmission protocol .....	101
3.2.1.	Protocols .....	101
3.2.2.	ATR .....	102
3.2.3.	PTS .....	103
3.3.	Access conditions (AC) .....	103
3.4.	Data encryption .....	104
3.5.	Commands and error codes overview .....	104
3.6.	Commands description .....	105
3.6.1.	Select file .....	105
3.6.1.1.	Selection by name (AID) .....	105
3.6.1.2.	Selection of an elementary file using its file identifier .....	106
3.6.2.	Read Binary .....	106
3.6.2.1.	Command without secure messaging .....	107
3.6.2.2.	Command with secure messaging .....	107
3.6.3.	Update Binary .....	109
3.6.3.1.	Command without secure messaging .....	109
3.6.3.2.	Command with secure messaging .....	110
3.6.4.	Get challenge .....	111
3.6.5.	Verify .....	111
3.6.6.	Get response .....	112
3.6.7.	PSO: verify certificate .....	112
3.6.8.	Internal authenticate .....	113

---

3.6.9.	External authenticate .....	114
3.6.10.	Manage security environment .....	115
3.6.11.	PSO: hash .....	116
3.6.12.	Perform hash of file .....	116
3.6.13.	PSO: compute digital signature .....	117
3.6.14.	PSO: verify digital signature .....	118
4.	Tachograph cards structure .....	118
4.1.	Driver card structure .....	119
4.2.	Workshop card structure .....	121
4.3.	Control card structure .....	123
4.4.	Company card structure .....	125

## 1. INTRODUCTION

### 1.1. Abbreviations

For the purpose of this appendix, the following abbreviations apply:

AC	access conditions
AID	application identifier
ALW	always
APDU	application protocol data unit (structure of a command)
ATR	answer to reset
AUT	authenticated
C6, C7	contacts No 6 and 7 of the card as described in ISO/IEC 7816-2
cc	clock cycles
CHV	card holder verification information
CLA	class byte of an APDU command
DF	dedicated file. A DF can contain other files (EF or DF)
EF	elementary file
ENC	encrypted: access is possible only by encoding data
etu	elementary time unit
IC	integrated circuit
ICC	integrated circuit card
ID	identifier
IFD	interface device
IFS	information field size
IFSC	information field size for the card
IFSD	information field size device (for the terminal)
INS	instruction byte of an APDU command
Lc	length of the input data for a APDU command
Le	length of the expected data (output data for a command)
MF	master file (root DF)
P1-P2	parameter bytes
NAD	node address used in T=1 protocol
NEV	never
PIN	personal identification number
PRO SM	protected with secure messaging
PTS	protocol transmission selection
RFU	reserved for future use

RST	reset (of the card)
SM	secure messaging
SW1-SW2	status bytes
TS	initial ATR character
VPP	programming voltage
XXh	value XX in hexadecimal notation
	concatenation symbol 03  04=0304.

## 1.2. References

The following references are used in this Appendix:

- EN 726-3 Identification cards systems — Telecommunications integrated circuit(s) cards and terminals — Part 3: Application independent card requirements. December 1994.
- ISO/IEC 7816-2 Information technology — Identification cards — Integrated circuit(s) cards with contacts — Part 2: Dimensions and location of the contacts. First edition: 1999.
- ISO/IEC 7816-3 Information technology — Identification cards — Integrated circuit(s) cards with contacts — Part 3: Electronic signals and transmission protocol. Edition 2: 1997.
- ISO/IEC 7816-4 Information technology — Identification cards — Integrated circuit(s) cards with contacts — Part 4: Interindustry commands for interexchange. First edition: 1995 + Amendment 1: 1997.
- ISO/IEC 7816-6 Information technology — Identification cards — Integrated circuit(s) cards with contacts — Part 6: Interindustry data elements. First Edition: 1996 + Cor 1: 1998.
- ISO/IEC 7816-8 Information technology — Identification cards — Integrated circuit(s) cards with contacts — Part 8: Security related interindustry commands. First Edition: 1999.
- ISO/IEC 9797 Information technology — Security techniques — Data integrity mechanism using a cryptographic check function employing a block cipher algorithm. Edition 2: 1994.

## 2. ELECTRICAL AND PHYSICAL CHARACTERISTICS

TCS\_200 All electronic signals shall be in accordance with ISO/IEC 7816-3 unless specified otherwise.

TCS\_201 The location and dimensions of the card contacts shall comply with the ISO/IEC 7816-2.

### 2.1. Supply voltage and current consumption

TCS\_202 The card shall work according to specifications within the consumption limits specified in ISO/IEC 7816-3.

TCS\_203 The card shall work with  $V_{cc} = 3 \text{ V } (+/- 0,3 \text{ V})$  o  $V_{cc} = 5 \text{ V } (+/- 0,5 \text{ V})$ .

Voltage selection shall be performed according to ISO/IEC 7816-3.

## 2.2. Programming voltage $V_{pp}$

TCS\_204 The card shall not require a programming voltage at pin C6. It is expected that pin C6 is not connected in an IFD. Contact C6 may be connected to  $V_{cc}$  in the card but shall not be connected to ground. This voltage should not be interpreted in any case.

## 2.3. Clock generation and frequency

TCS\_205 The card shall operate within a frequency range of 1 to 5 MHz. Within one card session the clock frequency may vary  $\pm 2\%$ . The clock frequency is generated by the Vehicle Unit and not the card itself. The duty cycle may vary between 40 and 60 %.

TCS\_206 Under conditions contained into the card file  $EF_{ICC}$ , the external clock can be stopped. The first byte of the  $EF_{ICC}$  file body codes the Clockstop mode conditions (see EN 726-3 for further details):

Low	High		
Bit 3	Bit 2	Bit 1	
0	0	1	Clockstop allowed, no preferred level
0	1	1	Clockstop allowed, high level preferred
1	0	1	Clockstop allowed, low level preferred
0	0	0	Clockstop not allowed
0	1	0	Clockstop only allowed on high level
1	0	0	Clockstop only allowed on low level

Bits 4 to 8 are not used.

## 2.4. I/O contact

TCS\_207 The I/O contact C7 is used to receive data from and to transmit data to the IFD. During operation only either the card or the IFD shall be in transmit mode. Should both units be in transmit mode no damage shall occur to the card. Unless transmitting, the card shall enter the reception mode.

## 2.5. States of the card

TCS\_208 The card works in two states while the supply voltage is applied:

- operation state while executing commands or interfacing with Digital Unit,
- idle state at all other times; in this state all data shall be retained by the card.

## 3. HARDWARE AND COMMUNICATION

### 3.1. Introduction

This paragraph describes the minimum functionality required by Tachograph cards and VUs to ensure correct operation and interoperability.

Tachograph cards are as compliant as possible with the available ISO/IEC applicable norms (especially ISO/IEC 7816). However, commands and protocols are fully described in order to specify some restricted usage or some differences if they exist. The commands specified are fully compliant with the referred norms except where indicated.

### 3.2. Transmission protocol

TCS\_300 The Transmission protocol shall be compliant with ISO/IEC 7816-3. In particular, the VU shall recognise waiting time extensions sent by the card.

#### 3.2.1. Protocols

TCS\_301 The card shall provide both protocol T=0 and protocol T=1.

TCS\_302 T=0 is the default protocol, a PTS command is therefore necessary to change the protocol to T=1.

TCS\_303 Devices shall support direct convention in both protocols: the direct convention is hence mandatory for the card.

TCS\_304 The Information Field Size Card byte shall be presented at the ATR in character TA3. This value shall be at least 'F0h' (= 240 bytes).

The following restrictions apply to the protocols:

TCS\_305 T=0

- The interface device shall support an answer on I/O after the rising edge of the signal on RST from 400 cc.
- The interface device shall be able to read characters separated with 12 etu.
- The interface device shall read an erroneous character and its repetition if separated with 13 etu. If an erroneous character is detected, the Error signal on I/O can occur between 1 etu and 2 etu. The device shall support a 1 etu delay.
- The interface device shall accept a 33 bytes ATR (TS+32)
- If TC1 is present in the ATR, the Extra Guard Time shall be present for characters sent by the interface device although characters sent by the card can still be separated with 12 etu. This is also true for the ACK character sent by the card after a P3 character emitted by the interface device.
- The interface device shall take into account a NUL character emitted by the card.
- The interface device shall accept the complementary mode for ACK.
- The get-response command cannot be used in chaining mode to get a data which length could exceed 255 bytes.

TCS\_306 T=1

- NAD byte: not used (NAD shall be set to '00').
- S-block ABORT: not used.
- S-block VPP state error: not used.
- The total chaining length for a data field will not exceed 255 bytes (to be ensured by the IFD).
- The Information Field Size Device (IFSD) shall be indicated by the IFD immediately after the ATR: the IFD shall transmit the S-Block IFS request after the ATR and the card shall send back S-Block IFS. The recommended value for IFSD is 254 bytes.
- The card will not ask for an IFS readjustment.

### 3.2.2. ATR

TCS\_307 The device checks ATR bytes, according to ISO/IEC 7816-3. No verification shall be done on ATR Historical Characters.

**Example of Basic Biprotocol ATR** according to ISO/IEC 7816-3

Character	Value	Remarks
TS	'3Bh'	Indicates direct convention
T0	'85h'	TD1 present; 5 historical bytes are presents
TD1	'80h'	TD2 present; T=0 to be used
TD2	'11h'	TA3 present; T=1 to be used
TA3	'XXh' (mind. 'F0h')	Information Field Size Card (IFSC)
TH1 bis TH5	'XXh'	Historical characters
TCK	'XXh'	Check character (exclusive OR)

TCS\_308 After the Answer To Reset (ATR), the Master File (MF) is implicitly selected and becomes the Current Directory.

### 3.2.3. PTS

TCS\_309 The default Protocol is T=0. To set the T=1 protocol, a PTS (also known as PPS) must be sent to the card by the device.

TCS\_310 As both T=0 and T=1 protocols are mandatory for the card, the basic PTS for protocol switching is mandatory for the card.

The PTS can be used, as indicated in ISO/IEC 7816-3, to switch to higher baud rates than the default one proposed by the card in the ATR if any (TA(1) byte).

Higher baud rates are optional for the card.

TCS\_311 If no other baud rate than the default one are supported (or if the selected baud rate is not supported), the card shall respond to the PTS correctly according to ISO/IEC 7816-3 by omitting the PPS1 byte.

Examples of basic PTS for protocol selection are the following:

Character	Value	Remarks
PPSS	'FFh'	The initiate character
PPS0	'00h' or '01h'	PPS1 to PPS3 are not present; '00h' to select T0, '01h' to select T1
PK	'XXh'	Check character: 'XXh' = 'FFh' if PPS0 = '00h' 'XXh' = 'FEh' if PPS0 = '01h'

### 3.3. Access conditions (AC)

Access Conditions (AC) for the UPDATE\_BINARY and READ\_BINARY commands are defined for each Elementary File.

TCS\_312 The AC of the current file must be met before accessing the file via these commands.

The definitions of the available access conditions are the following:

- ALW: The action is always possible and can be executed without any restriction.
- NEV: The action is never possible.
- AUT: The right corresponding a successful external authentication must be opened up (done by the EXTERNAL\_AUTHENTICATE command).
- PRO SM: Command must be transmitted with a cryptographic checksum using secure messaging (See Appendix 11).
- AUT and PRO SM (combined)

On the processing commands (UPDATE\_BINARY and READ\_BINARY), the following access conditions can be set in the card:

	UPDATE_BINARY	READ_BINARY
ALW	Yes	Yes
NEV	Yes	Yes
AUT	Yes	Yes
PRO SM	Yes	No
AUT and PRO SM	Yes	No

The PRO SM access condition is not available for the READ\_BINARY command. It means that the presence of a cryptographic checksum for a READ command is never mandatory. However, using the value 'OC' for the class, it is possible to use the READ\_BINARY command with secure messaging, as described in paragraph 3.6.2.

### 3.4. Data encryption

When confidentiality of data to be read from a file needs to be protected, the file is marked as "Encrypted". Encryption is performed using secure messaging (See Appendix 11).

### 3.5. Commands and error codes overview

Commands and file organisation are deduced from and complies with ISO/IEC 7816-4.

TCS\_313 This section describes the following APDU command-response pairs:

Command	INS
SELECT FILE	A4
READ BINARY	B0
UPDATE BINARY	D6
GET CHALLENGE	84
VERIFY	20
GET RESPONSE	C0
PERFORM SECURITY OPERATION: VERIFY CERTIFICATE COMPUTE DIGITAL SIGNATURE VERIFY DIGITAL SIGNATURE HASH	2A
INTERNAL AUTHENTICATE	88
EXTERNAL AUTHENTICATE	82
MANAGE SECURITY ENVIRONMENT: SETTING A KEY	22
PERFORM HASH OF FILE	2A

TCS\_314 The status word SW1 SW2 are returned in any response message and denote the processing state of the command.

SW1	SW2	Meaning
90	00	Normal processing
61	XX	Normal processing. XX = number of response bytes available
62	81	Warning processing. Part of returned data may be corrupted
63	CX	Wrong CHV (PIN). Remaining attempts counter provided by 'X'
64	00	Execution error — State of non-volatile memory unchanged. Integrity error
65	00	Execution error — State of non-volatile memory changed
65	81	Execution error — State of non-volatile memory changed — Memory failure
66	88	Security error: wrong Cryptographic checksum (during secure messaging) or wrong certificate (during certificate verification) or wrong cryptogram (during external authentication) or wrong signature (during signature verification)
67	00	Wrong length (wrong Lc or Le)
69	00	Forbidden command (no response available in T=0)
69	82	Security status not satisfied
69	83	Authentication method blocked
69	85	Conditions of use not satisfied
69	86	Command not allowed (no current EF)
69	87	Expected secure messaging data objects missing
69	88	Incorrect secure messaging data objects
6A	82	File not found
6A	86	Wrong parameters P1-P2
6A	88	Referenced data not found
6B	00	Wrong parameters (offset outside the EF)



SW1	SW2	Meaning
6C	XX	Wrong length, SW2 indicates the exact length. No data field is returned
6D	00	Instruction code not supported or invalid
6E	00	Class not supported
6F	00	Other checking errors

### 3.6. Commands description

The mandatory commands for the Tachograph cards are described in this chapter.

Additional relevant details, related to cryptographic operations involved, are given in Appendix 11 Common security mechanisms.

All commands are described independently of the used protocol (T=0 or T=1). The APDU bytes CLA, INS, P1, P2, Lc and Le are always indicated. If Lc or Le is not needed for the described command, the associated length, value and description are empty.

TCS\_315 If both length bytes (Lc and Le) are requested, the described command has to be split in two parts if the IFD is using protocol T=0: the IFD sends the command as described with P3=Lc + data and then sends a GET\_RESPONSE (see point 3.6.6) command with P3=Le.

TCS\_316 If both length bytes are requested, and Le=0 (secure messaging):

- When using protocol T=1, the card shall answer to Le=0 by sending all available output data.
- When using protocol T=0, the IFD shall send the first command with P3=Lc + data, the card shall answer (to this implicit Le=0) by the Status bytes '61La', where La is the number of response bytes available. The IFD shall then generate a GET RESPONSE command with P3=La to read the data.

#### 3.6.1. Select file

This command is compliant with ISO/IEC 7816-4, but has a restricted usage compared to the command defined in the norm.

The SELECT FILE command is used:

- to select an application DF (selection by name must be used)
- to select an elementary file corresponding to the submitted file ID

##### 3.6.1.1. Selection by name (AID)

This command allows to select an application DF in the card.

TCS\_317 This command can be performed from anywhere in the file structure (after the ATR or at anytime).

TCS\_318 The selection of an application resets the current security environment. After performing the application selection, no current public key is selected anymore and the former session key is no longer available for secure messaging. The AUT access condition is also lost.

TCS\_319 Command Message

Byte	Length	Value	Description
CLA	1	'00h'	
INS	1	'A4h'	
P1	1	'04h'	Selection by name (AID)
P2	1	'0Ch'	No response expected
Lc	1	'NNh'	Number of bytes sent to the card (length of the AID): '06h' for the Tachograph application
#6-#(5+NN)	NN	'XX..XXh'	AID: 'FF 54 41 43 48 4F' for the Tachograph application

No response to the SELECT FILE command is needed (Le absent in T=1, or no response asked in T=0).

TCS\_320 Response Message (no response asked)

Byte	Length	Value	Description
SW	2	'XXXXh'	Status Words (SW1, SW2)

- If the command is successful, the card returns '9000',
- if the application corresponding with the AID is not found, the processing state returned is '6A82',
- in T=1, if the byte Le is present, the state returned is '6700',
- in T=0, if a response is asked after the SELECT FILE command, the state returned is '6900',
- if the selected application is considered corrupted (integrity error is detected within the file attributes), the processing state returned is '6400' or '6581'.

3.6.1.2. Selection of an elementary file using its file identifier

TCS\_321 Command Message

Byte	Length	Value	Description
CLA	1	'00h'	
INS	1	'A4h'	
P1	1	'02h'	Selection of an EF under the current DF
P2	1	'0Ch'	No response expected
Lc	1	'02h'	Number of bytes sent to the card
#6-#7	2	'XXXXh'	File Identifier

No response to the SELECT FILE command is needed (Le absent in T=1, or no response asked in T=0).

TCS\_322 Response Message (no response asked)

Byte	Length	Value	Description
SW	2	'XXXXh'	Status Words (SW1, SW2)

- If the command is successful, the card returns '9000',
- if the file corresponding with the file identifier is not found, the processing state returned is '6A82',
- in T=1, if the byte Le is present, the state returned is '6700',
- in T=0, if a response is asked after the SELECT FILE command, the state returned is '6900',
- if the selected file is considered corrupted (integrity error is detected within the file attributes), the processing state returned is '6400' or '6581'.

3.6.2. **Read Binary**

This command is compliant with ISO/IEC 7816-4, but has a restricted usage compared to the command defined in the norm.

The Read Binary command is used to read data from a transparent file.

The response of the card consists of returning the data read, optionally encapsulated in a secure messaging structure.

TCS\_323 The command can be performed only if the security status satisfies the security attributes defined for the EF for the READ function.

3.6.2.1. *Command without secure messaging*

This command enables the IFD to read data from the EF currently selected, without secure messaging.

TCS\_324 Reading data from a file marked as "Encrypted" shall not be possible through this command.

## TCS\_325 Command Message

Byte	Length	Value	Description
CLA	1	'00h'	No secure messaging asked
INS	1	'B0h'	
P1	1	'XXh'	Offset in bytes from the beginning of the file: most significant byte
P2	1	'XXh'	Offset in bytes from the beginning of the file: least significant byte
Le	1	'XXh'	Length of data expected. number of bytes to be read

Note: bit 8 of P1 must be set to 0.

## TCS\_326 Response Message

Byte	Length	Value	Description
#1-#X	X	'XX..XXh'	Data read
SW	2	'XXXXh'	Status words (SW1, SW2)

- If the command is successful, the card returns '9000',
- if no EF is selected, the processing state returned is '6986',
- if the Access Control of the selected file are not satisfied, the command is interrupted with '6982',
- if the Offset is not compatible with the size of the EF (Offset > EF size), the processing state returned is '6B00',
- if the size of the data to be read is not compatible with the size of the EF (Offset + Le > EF size) the processing state returned is '6700' or '6Cxx', where 'xx' indicates the exact length,
- if an integrity error is detected within the file attributes, the card shall consider the file as corrupted and unrecoverable, the processing state returned is '6400' or '6581',
- if an integrity error is detected within the stored data, the card shall return the demanded data, and the processing state returned is '6281'.

3.6.2.2. *Command with secure messaging*

This command enables the IDF to read data from the EF currently selected with secure messaging, in order to verify the integrity of the data received and to protect the confidentiality of the data in the case the EF is marked as "Encrypted".

## TCS\_327 Command Message

Byte	Length	Value	Description
CLA	1	'0Ch'	Secure Messaging asked
INS	1	'B0h'	INS
P1	1	'XXh'	P1 (offset in bytes from the beginning of the file): Most Significant Byte
P2	1	'XXh'	P2 (offset in bytes from the beginning of the file): Least Significant Byte
Lc	1	'09h'	Length of input data for secure messaging
#6	1	'97h'	T <sub>LE</sub> : Tag for expected length specification
#7	1	'01h'	L <sub>LE</sub> : Length of expected length
#8	1	'NNh'	Expected length specification (original Le): Number of Bytes to be read

Byte	Length	Value	Description
#9	1	'8Eh'	T <sub>CC</sub> : Tag for cryptographic checksum
#10	1	'04h'	L <sub>CC</sub> : Length of following cryptographic checksum
#11-#14	4	'XX..XXh'	Cryptographic checksum (4 most significant bytes)
Le	1	'00h'	As specified in ISO/IEC 7816-4

TCS\_328 Response Message if EF is not marked as "Encrypted" and if Secure Messaging input format is correct:

Byte	Length	Value	Description
#1	1	'81h'	T <sub>PV</sub> : Tag for plain value data
#2	L	'NNh' or '81 NNh'	L <sub>PV</sub> : length of returned data (= original Le) L is 2 bytes if L <sub>PV</sub> > 127 bytes
#(2+L)-#(1+L+NN)	NN	'XX..XXh'	Plain Data value
#(2+L+NN)	1	'8Eh'	T <sub>CC</sub> : Tag for cryptographic checksum
#(3+L+NN)	1	'04h'	L <sub>CC</sub> : Length of following cryptographic checksum
#(4+L+NN)-#(7+L+NN)	4	'XX..XXh'	Cryptographic checksum (4 most significant bytes)
SW	2	'XXXXh'	Status Words (SW1, SW2)

TCS\_329 Response Message if EF is marked as "Encrypted" and if Secure Messaging input format is correct:

Byte	Length	Value	Description
#1	1	'87h'	T <sub>PI CG</sub> : Tag for encrypted data (cryptogram)
#2	L	'MMh' or '81 MMh'	L <sub>PI CG</sub> : length of returned encrypted data (different of original Le of the command due to padding) L is 2 byte if L <sub>PI CG</sub> > 127 bytes
#(2+L)-#(1+L+MM)	MM	'01XX..XXh'	Encrypted data: padding indicator and cryptogram
#(2+L+MM)	1	'8Eh'	T <sub>CC</sub> : tag for cryptographic checksum
#(3+L+MM)	1	'04h'	L <sub>CC</sub> : length of following cryptographic checksum
#(4+L+MM)-#(7+L+MM)	4	'XX..XXh'	Cryptographic checksum (4 most significant bytes)
SW	2	'XXXXh'	Status words (SW1, SW2)

The encrypted data returned contain a first byte indicating the used padding mode. For the tachograph application, the padding indicator always takes the value '01h', indicating that the used padding mode is the one specified in ISO/IEC 7816-4 (one byte with value '80h' followed by some null bytes: ISO/IEC 9797 method 2).

The "regular" processing states, described for the READ BINARY command with no secure messaging (see point 3.6.2.1), can be returned using the response message structures described above, under a '99h' Tag (as described in TCS 335).

Additionally, some errors specifically related to secure messaging can happen. In that case, the processing state is simply returned, with no secure messaging structure involved:

TCS\_330 Response Message if incorrect Secure Messaging input format

Byte	Length	Value	Description
SW	2	'XXXXh'	Status words (SW1, SW2)

— If no current session key is available, the processing state '6A88' is returned. It happens either if the session key has not already been generated or if the session key validity has expired (in this case the IFD must re-run a mutual authentication process to set a new session key).

— If some expected data objects (as specified above) are missing in the secure messaging format, the processing state '6987' is returned: this error happens if an expected tag is missing or if the command body is not properly constructed.

- If some data objects are incorrect, the processing state returned is '6988': this error happens if all the required tags are present but some lengths are different from the ones expected.
- If the verification of the cryptographic checksum fails, the processing state returned is '6688'.

### 3.6.3. Update Binary

This command is compliant with ISO/IEC 7816-4, but has a restricted usage compared to the command defined in the norm.

The UPDATE BINARY command message initiates the update (erase + write) of the bits already present in an EF binary with the bits given in the command APDU.

TCS\_331 The command can be performed only if the security status satisfies the security attributes defined for the EF for the UPDATE function (If the access control of the UPDATE function includes PRO SM, a secure messaging must be added in the command).

#### 3.6.3.1. Command without secure messaging

This command enables the IFD to write data into the EF currently selected, without the card verifying the integrity of data received. This plain mode is allowed only if the related file is not marked as "Encrypted".

TCS\_332 Command Message

Byte	Length	Value	Description
CLA	1	'00h'	No secure messaging asked
INS	1	'D6h'	
P1	1	'XXh'	Offset in bytes from the beginning of the file: most significant byte
P2	1	'XXh'	Offset in bytes from the beginning of the file: least significant byte
Lc	1	'NNh'	Lc length of data to Update. Number of bytes to be written
#6-#(5+NN)	NN	'XX..XXh'	Data to be written

Note: bit 8 of P1 must be set to 0.

TCS\_333 Response Message

Byte	Length	Value	Description
SW	2	'XXXXh'	Status words (SW1, SW2)

- If the command is successful, the card returns '9000',
- if no EF is selected, the processing state returned is '6986',
- if the Access Control of the selected file are not satisfied, the command is interrupted with '6982',
- if the Offset is not compatible with the size of the EF (Offset > EF size), the processing state returned is '6B00',
- if the size of the data to be written is not compatible with the size of the EF (Offset + Le > EF size) the processing state returned is '6700',
- if an integrity error is detected within the file attributes, the card shall consider the file as corrupted and unrecoverable, the processing state returned is '6400' or '6500',
- if writing is unsuccessful, the processing state returned is '6581'.

## 3.6.3.2. Command with secure messaging

This command enables the IFD to write data into the EF currently selected, with the card verifying the integrity of data received. As no confidentiality is required, the data are not encrypted.

## TCS\_334 Command Message

Byte	Length	Value	Description
CLA	1	'0Ch'	Secure messaging. Asked
INS	1	'D6h'	INS
P1	1	'XXh'	Offset in bytes from the beginning of the file: most significant byte
P2	1	'XXh'	Offset in bytes from the beginning of the file: least significant byte
Lc	1	'XXh'	Length of the secured data field
#6	1	'81h'	T <sub>PV</sub> : tag for plain value data
#7	L	'NNh' or '81NNh'	L <sub>PV</sub> : length of transmitted data L is 2 bytes if L <sub>PV</sub> > 127 bytes
#(7+L)-#(6+L+NN)	NN	'XX..XXh'	Plain data value (data to be written)
#(7+L+NN)	1	'8Eh'	T <sub>CC</sub> : tag for cryptographic checksum
#(8+L+NN)	1	'04h'	L <sub>CC</sub> : Length of following cryptographic checksum
#(9+L+NN)-#(12+L+NN)	4	'XX..XXh'	Cryptographic checksum (4 most significant bytes)
Le	1	'00h'	As specified in ISO/IEC 7816-4

## TCS\_335 Response message if correct Secure Messaging input format

Byte	Length	Value	Description
#1	1	'99h'	T <sub>SW</sub> : tag for status words (to be protected by CC)
#2	1	'02h'	L <sub>SW</sub> : length of returned status words
#3-#4	2	'XXXXh'	Status words (SW1, SW2)
#5	1	'8Eh'	T <sub>CC</sub> : tag for cryptographic checksum
#6	1	'04h'	L <sub>CC</sub> : Length of following cryptographic checksum
#7-#10	4	'XX..XXh'	Cryptographic checksum (4 most significant bytes)
SW	2	'XXXXh'	Status words (SW1, SW2)

The "regular" processing states, described for the UPDATE BINARY command with no secure messaging (see point 3.6.3.1), can be returned using the response message structure described above.

Additionally, some errors specifically related to secure messaging can happen. In that case, the processing state is simply returned, with no secure messaging structure involved:

## TCS\_336 Response Message if error in secure messaging

Byte	Length	Value	Description
SW	2	'XXXXh'	Status Words (SW1, SW2)

- If no current session key is available, the processing state '6A88' is returned,
- if some expected data objects (as specified above) are missing in the secure messaging format, the processing state '6987' is returned: this error happens if an expected tag is missing or if the command body is not properly constructed,
- if some data objects are incorrect, the processing state returned is '6988': this error happens if all the required tags are present but some lengths are different from the ones expected,
- if the verification of the cryptographic checksum fails, the processing state returned is '6688'.

### 3.6.4. *Get challenge*

This command is compliant with ISO/IEC 7816-4, but has a restricted usage compared to the command defined in the norm.

The GET CHALLENGE command asks the card to issue a challenge in order to use it in a security related procedure in which a cryptogram or some ciphered data are sent to the card.

TCS\_337 The Challenge issued by the card is only valid for the next command, which uses a challenge, sent to the card.

TCS\_338 Command Message

Byte	Length	Value	Description
CLA	1	'00h'	CLA
INS	1	'84h'	INS
P1	1	'00h'	P1
P2	1	'00h'	P2
Le	1	'08h'	Le (Length of challenge expected)

TCS\_339 Response Message

Byte	Length	Value	Description
#1-#8	8	'XX..XXh'	Challenge
SW	2	'XXXXh'	Status words (SW1, SW2)

- If the command is successful, the card returns '9000',
- if Le is different from '08h', the processing state is '6700',
- if parameters P1-P2 are incorrect, the processing state is '6A86'.

### 3.6.5. *Verify*

This command is compliant with ISO/IEC 7816-4, but has a restricted usage compared to the command defined in the norm.

The Verify command initiates the comparison in the card of the CHV (PIN) data sent from the command with the reference CHV stored in the card.

Note: The PIN entered by the user must be right padded with FFh' bytes up to a length of 8 bytes by the IFD.

TCS\_340 If the command is successful, the rights corresponding to CHV presentation are opened and the remaining CHV attempt counter is reinitialised.

TCS\_341 An unsuccessful comparison is recorded in the card in order to limit the number of further attempts of the use of the reference CHV.

TCS\_342 Command Message

Byte	Length	Value	Description
CLA	1	'00h'	CLA
INS	1	'20h'	INS
P1	1	'00h'	P1
P2	1	'00h'	P2 (the verified CHV is implicitly known)
Lc	1	'08h'	Length of CHV code transmitted
#6-#13	8	'XX..XXh'	CHV

## TCS\_343 Response Message

Byte	Length	Value	Description
SW	2	'XXXXh'	Status words (SW1, SW2)

- If the command is successful, the card returns '9000'.
- if the reference CHV is not found, the processing state returned is '6A88'.
- if the CHV is blocked, (the remaining attempt counter of the CHV is null), the processing state returned is '6983'. Once in that state, the CHV can never be successfully presented anymore.
- if the comparison is unsuccessful, the remaining attempt Counter is decreased and the status '63CX' is returned (X > 0, and X equals the remaining CHV attempts counter. X = 'F', the CHV attempts counter is greater than 'F').
- if the reference CHV is considered corrupted, the processing state returned is '6400' or '6581'.

3.6.6. **Get response**

This command is compliant with ISO/IEC 7816-4.

This command (only necessary and available for T=0 Protocol) is used to transmit prepared data from the card to the interface device (case where a command had included both Lc and Le).

The GET\_RESPONSE command has to be issued immediately after the command preparing the data, otherwise, the data are lost. After the execution of the GET\_RESPONSE command (except if the error '61xx' or '6Cxx' occur, see below), the previously prepared data are no longer available.

## TCS\_344 Command Message

Byte	Length	Value	Description
CLA	1	'00h'	
INS	1	'C0h'	
P1	1	'00h'	
P2	1	'00h'	
Le	1	'XXh'	Number of bytes expected

## TCS\_345 Response Message

Byte	Length	Value	Description
#1-#X	X	'XX..XXh'	Data
SW	2	'XXXXh'	Status words (SW1, SW2)

- If the command is successful, the card returns '9000'.
- If no data have been prepared by the card, the processing state returned is '6900' or '6F00'.
- If Le exceeds the number of available bytes or if Le is null, the processing state returned is '6Cxx', where 'xx' denotes the exact number of available bytes. In that case, the prepared data are still available for a subsequent GET\_RESPONSE command.
- If Le is not null and is smaller than the number of available bytes, the required data are sent normally by the card, and the processing state returned is '61xx', where 'xx' indicates a number of extra bytes still available by a subsequent GET\_RESPONSE command.
- If the command is not supported (protocol T=1), the card returns '6D00'.

3.6.7. **PSO: verify certificate**

This command is compliant with ISO/IEC 7816-8, but has a restricted usage compared to the command defined in the norm.



The VERIFY CERTIFICATE command is used by the card to obtain a Public Key from the outside and to check its validity.

TCS\_346 When a VERIFY CERTIFICATE command is successful, the Public Key is stored for a future use in the Security environment. This key shall be explicitly set for the use in security related commands (INTERNAL AUTHENTICATE, EXTERNAL AUTHENTICATE or VERIFY CERTIFICATE) by the MSE command (see point 3.6.10) using its key identifier.

TCS\_347 In any case, the VERIFY CERTIFICATE command uses the public key previously selected by the MSE command to open the certificate. This public key must be the one of a Member State or of Europe.

TCS\_348 Command Message

Byte	Length	Value	Description
CLA	1	'00h'	CLA
INS	1	'2Ah'	Perform Security Operation
P1	1	'00h'	P1
P2	1	'AEh'	P2: non BER-TLV coded data (concatenation of data elements)
Lc	1	'CEh'	Lc: Length of the certificate, 194 bytes
#6-#199	194	'XX..XXh'	Certificate: concatenation of data elements (as described in Appendix 11)

TCS\_349 Response Message

Byte	Length	Value	Description
SW	2	'XXXXh'	Status words (SW1, SW2)

- If the command is successful, the card returns '9000',
- if the certificate verification fails, the processing state returned is '6688'. The verification and unwrapping process of the certificate is described in Appendix 11,
- if no Public Key is present in the Security Environment, '6A88' is returned,
- if the selected public key (used to unwrap the certificate) is considered corrupted, the processing state returned is '6400' or '6581',
- if the selected public key (used to unwrap the certificate) has a CHA.LSB (CertificateHolderAuthorisation.equipmentType) different from '00' (i.e. is not the one of a Member State or of Europe), the processing state returned is '6985'.

### 3.6.8. Internal authenticate

This command is compliant with ISO/IEC 7816-4.

Using the INTERNAL AUTHENTICATE command, the IFD can authenticate the card.

The authentication process is described in Appendix 11. It includes the following statements:

TCS\_350 The INTERNAL AUTHENTICATE command uses the card Private Key (implicitly selected) to sign authentication data including K1 (first element for session key agreement) and RND1, and uses the Public Key currently selected (through the last MSE command) to encrypt the signature and form the authentication token (more details in Appendix 11).

## TCS\_351 Command Message

Byte	Length	Value	Description
CLA	1	'00h'	CLA
INS	1	'88h'	INS
P1	1	'00h'	P1
P2	1	'00h'	P2
Lc	1	'10h'	Length of data sent to the card
#6-#13	8	'XX..XXh'	Challenge used to authenticate the card
#14-#21	8	'XX..XXh'	VU.CHR (see Appendix 11)
Le	1	'80h'	Length of the data expected from the card

## TCS\_352 Response Message

Byte	Length	Value	Description
#1-#128	128	'XX..XXh'	Card authentication token (see Appendix 11)
SW	2	'XXXXh'	Status words (SW1, SW2)

- If the command is successful, the card returns '9000',
- if no Public Key is present in the Security Environment, the processing state returned is '6A88',
- if no Private Key is present in the Security Environment, the processing state returned is '6A88',
- if VU.CHR does not match the current public key identifier, the processing state returned is '6A88',
- if the selected private key is considered corrupted, the processing state returned is '6400' or '6581'.

TCS\_353 If the INTERNAL\_AUTHENTICATE command is successful, the current session key, if existing, is erased and no longer available. In order to have a new session key available, the EXTERNAL\_AUTHENTICATE command must be successfully performed.

### 3.6.9. External authenticate

This command is compliant with ISO/IEC 7816-4.

Using the EXTERNAL AUTHENTICATE command, the card can authenticate the IFD.

The authentication process is described in Appendix 11. It includes the following statements:

TCS\_354 A GET CHALLENGE command must precede the EXTERNAL\_AUTHENTICATE command immediately. The card issues a challenge to the outside (RND3).

TCS\_355 The verification of the cryptogram uses RND3 (challenge issued by the card), the card private key (implicitly selected) and the public key previously selected by the MSE command.

TCS\_356 The card verifies the cryptogram, and if it is correct, the AUT access condition is opened.

TCS\_357 The input cryptogram carries the second element for session key agreement K2.

## TCS\_358 Command Message

Byte	Length	Value	Description
CLA	1	'00h'	CLA
INS	1	'82h'	INS
P1	1	'00h'	P1
P2	1	'00h'	P2 (the public key to be used is implicitly known, and has been previously set by the MSE command)
Lc	1	'80h'	Lc (Length of the data sent to the card)
#6-#133	128	'XX..XXh'	Cryptogram (see Appendix 11)

## TCS\_359 Response Message

Byte	Length	Value	Description
SW	2	'XXXXh'	Status words (status words (SW1, SW2))

- If the command is successful, the card returns '9000',
- if no Public Key is present in the Security Environment, '6A88' is returned,
- if the CHA of the currently set public key is not the concatenation of the Tachograph application AID and of a VU equipment Type, the processing state returned is '6F00' (see Appendix 11),
- if no Private Key is present in the Security Environment, the processing state returned is '6A88',
- if the verification of the cryptogram is wrong, the processing state returned is '6688',
- if the command is not immediately preceded with a GET CHALLENGE command, the processing state returned is '6985',
- if the selected private key is considered corrupted, the processing state returned is '6400' or '6581'.

TCS\_360 If the EXTERNAL AUTHENTICATE command is successful, and if the first part of the session key is available from a successful INTERNAL AUTHENTICATE recently performed, the session key is set for future commands using secure messaging.

TCS\_361 If the first session key part is not available from a previous INTERNAL AUTHENTICATE command, the second part of the session key, sent by the IFD, is not stored in the card. This mechanism ensures that the mutual authentication process is done in the order specified in Appendix 11.

### 3.6.10. Manage security environment

This command is used to set a public key for authentication purpose.

This command is compliant with ISO/IEC 7816-8. The use of this command is restricted regarding the related standard.

TCS\_362 The key referenced in the MSE data field is valid for every file of the Tachograph DF.

TCS\_363 The key referenced in the MSE data field remains the current public key until the next correct MSE command.

TCS\_364 If the key referenced is not (already) present into the card, the security environment remains unchanged.

## TCS\_365 Command Message

Byte	Length	Value	Description
CLA	1	'00h'	CLA
INS	1	'22h'	INS
P1	1	'C1h'	P1: referenced key valid for all cryptographic operations
P2	1	'B6h'	P2 (referenced data concerning digital signature)
Lc	1	'0Ah'	Lc: length of subsequent data field
#6	1	'83h'	Tag for referencing a public key in asymmetric cases
#7	1	'08h'	Length of the key reference (key identifier)
#8-#15	08h	'XX..XXh'	Key identifier as specified in Appendix 11

## TCS\_366 Response Message

Byte	Length	Value	Description
SW	2	'XXXXh'	Status words (SW1, SW2)

- If the command is successful, the card returns '9000',
- if the referenced key is not present into the card, the processing state returned is '6A88',
- if some expected data objects are missing in the secure messaging format, the processing state '6987' is returned. This can happen if the tag '83h' is missing,
- if some data objects are incorrect, the processing state returned is '6988'. This can happen if the length of the key identifier is not '08h',
- if the selected key is considered corrupted, the processing state returned is '6400' or '6581'.

3.6.11. **PSO: hash**

This command is used to transfer to the card the result of a hash calculation on some data. This command is used for the verification of digital signatures. The hash value is stored in EEPROM for the subsequent command verify digital signature.

This command is compliant with ISO/IEC 7816-8. The use of this command is restricted regarding the related standard.

## TCS\_367 Command Message

Byte	Length	Value	Description
CLA	1	'00h'	CLA
INS	1	'2Ah'	Perform security operation
P1	1	'90h'	Return hash code
P2	1	'A0h'	Tag: data field contains DOs relevant for hashing
Lc	1	'16h'	Length Lc of the subsequent data field
#6	1	'90h'	Tag for the hash code
#7	1	'14h'	Length of the hash code
#8-#27	20	'XX..XXh'	Hash code

## TCS\_368 Response Message

Byte	Length	Value	Description
SW	2	'XXXXh'	Status words (SW1, SW2)

- If the command is successful, the card returns '9000',
- if some expected data objects (as specified above) are missing, the processing state '6987' is returned. This can happen if one of the tag '90h' is missing,
- if some data objects are incorrect, the processing state returned is '6988'. This error happens if the required tag is present but with a length different from '14h'.

3.6.12. **Perform hash of file**

This command is not compliant with ISO/IEC 7816-8. Thus the CLA byte of this command indicates that there is a proprietary use of the PERFORM SECURITY OPERATION/HASH.

TCS\_369 The perform hash file command is used to hash the data area of the currently selected transparent EF.

TCS\_370 The result of the hash operation is stored in the card. It can then be used to get a digital signature of the file, using the PSO-COMPUTE\_DIGITAL\_SIGNATURE command. This result remains available for the COMPUTE DIGITAL SIGNATURE command until the next successful PERFORM HASH of FILE command.

TCS\_371 Command Message

Byte	Length	Value	Description
CLA	1	'80h'	CLA
INS	1	'2Ah'	Perform security operation
P1	1	'90h'	Tag: hash
P2	1	'00h'	P2: hash the data of the currently selected transparent file

TCS\_372 Response Message

Byte	Length	Value	Description
SW	2	'XXXXh'	Status words (SW1, SW2)

- If the command is successful, the card returns '9000',
- if no application is selected, the processing state '6985' is returned,
- if the selected EF is considered corrupted (file attributes or stored data integrity errors), the processing state returned is '6400' or '6581',
- if the selected file is not a transparent file, the processing state returned is '6986'.

### 3.6.13. PSO: compute digital signature

This command is used to compute the digital signature of previously computed hash code (see PERFORM HASH of FILE, point 3.6.12).

This command is compliant with ISO/IEC 7816-8. The use of this command is restricted regarding the related standard.

TCS\_373 The card private key is used to compute the digital signature and is implicitly known by the card.

TCS\_374 The card performs a digital signature using a padding method compliant with PKCS1 (see Appendix 11 for details).

TCS\_375 Command Message

Byte	Length	Value	Description
CLA	1	'00h'	CLA
INS	1	'2Ah'	Perform security operation
P1	1	'9Eh'	Digital signature to be returned
P2	1	'9Ah'	Tag: data field contains data to be signed. As no data field is included, the data are supposed to be already present in the card (hash of file)
Le	1	'80h'	Length of the expected signature

TCS\_376 Response Message

Byte	Length	Value	Description
#1-#128	128	'XX..XXh'	Signature of the previously computed hash
SW	2	'XXXXh'	Status words (SW1, SW2)

- If the command is successful, the card returns '9000',
- if the implicitly selected private key is considered as corrupted, the processing state returned is '6400' or '6581'.

### 3.6.14. PSO: verify digital signature

This command is used to verify the digital signature, provided as an input, in accordance with PKCS1 of a message, whose hash is known to the card. The signature algorithm is implicitly known by the card.

This command is compliant with ISO/IEC 7816-8. The use of this command is restricted regarding the related standard.

TCS\_377 The Verify Digital Signature command always uses the public key selected by the previous Manage Security Environment command, and the previous hash code entered by a PSO: hash command.

TCS\_378 Command Message

Byte	Length	Value	Description
CLA	1	'00h'	CLA
INS	1	'2Ah'	Perform security operation
P1	1	'00h'	Tag: data field contains DOs relevant for verification
P2	1	'A8h'	
Lc	1	'83h'	Length Lc of the subsequent data field
#28	1	'9Eh'	Tag for digital signature
#29-#30	2	'8180h'	Length of digital signature (128 bytes, coded in accordance with ISO/IEC 7816-6)
#31-#158	128	'XX..XXh'	Digital signature content

TCS\_379 Response Message

Byte	Length	Value	Description
SW	2	'XXXXh'	Status words (SW1, SW2)

- If the command is successful, the card returns '9000',
- if the verification of the signature fails, the processing state returned is '6688'. The verification process is described in Appendix 11,
- if no public key is selected, the processing state returned is '6A88',
- if some expected data objects (as specified above) are missing, the processing state '6987' is returned. This can happen if one of the required tag is missing,
- if no hash code is available to process the command (as a result of a previous PSO: hash command), the processing state returned is '6985',
- if some data objects are incorrect, the processing state returned is '6988'. This can happen if one of the required data objects length is incorrect,
- if the selected public key is considered corrupted, the processing state returned is '6400' or '6581'.

## 4. TACHOGRAPH CARDS STRUCTURE

This paragraph specifies the file structures of the Tachograph cards for storage of accessible data,

It does not specify card manufacturer dependant internal structures, such as e.g. file headers, nor storage and handling of data elements needed for internal use only such as `EuropeanPublicKey`, `CardPrivateKey`, `TDesSessionKey` or `WorkshopCardPin`.

The useful storage capacity of Tachograph cards shall be of 11 Kbytes minimum. Greater capacities may be used. In such case, the structure of the card remains the same, but the number of records of some elements of the structure is increased. This paragraph specifies minimum and maximum values of these record numbers.

## 4.1. Driver card structure

TCS\_400 After its personalisation, the driver card shall have the following permanent file structure and file access conditions:

File	File ID	Access conditions		
		Read	Update	Encrypted
MF	3F00			
EF ICC	0002	ALW	NEV	No
EF IC	0005	ALW	NEV	No
DF Tachograph	0500			
EF Application_Identification	0501	ALW	NEV	No
EF Card_Certificate	C100	ALW	NEV	No
EF CA_Certificate	C108	ALW	NEV	No
EF Identification	0520	ALW	NEV	No
EF Card_Download	050E	ALW	ALW	No
EF Driving_Licence_Info	0521	ALW	NEV	No
EF Events_Data	0502	ALW	PRO SM / AUT	No
EF Faults_Data	0503	ALW	PRO SM / AUT	No
EF Driver_Activity_Data	0504	ALW	PRO SM / AUT	No
EF Vehicles_Used	0505	ALW	PRO SM / AUT	No
EF Places	0506	ALW	PRO SM / AUT	No
EF Current_Usage	0507	ALW	PRO SM / AUT	No
EF Control_Activity_Data	0508	ALW	PRO SM / AUT	No
EF Specific_Conditions	0522	ALW	PRO SM / AUT	No

TCS\_401 All EFs structures shall be transparent.

TCS\_402 Read with secure messaging shall be possible for all files under the DF Tachograph.

TCS\_403 The driver card shall have the following data structure:

File/Data element	No of Records	Size (bytes)		Default Values
		Min	Max	
MF		11411	24959	
EF ICC		25	25	
CardIccIdentification		25	25	
clockStop		1	1	{00}
cardExtendedSerialNumber		8	8	{00..00}
cardApprovalNumber		8	8	{20..20}
cardPersonaliserID		1	1	{00}
embedderIcAssemblerId		5	5	{00..00}
icIdentifier		2	2	{00 00}
EF IC		8	8	
CardChipIdentification		8	8	
icSerialNumber		4	4	{00..00}
icManufacturingReferences		4	4	{00..00}
DF Tachograph		11378	24926	
EF Application_Identification		10	10	
DriverCardApplicationIdentification		10	10	
typeOfTachographCardId		1	1	{00}
cardStructureVersion		2	2	{00 00}
noOfEventsPerType		1	1	{00}
noOfFaultsPerType		1	1	{00}
activityStructureLength		2	2	{00 00}
noOfCardVehicleRecords		2	2	{00 00}
noOfCardPlaceRecords		1	1	{00}
EF Card_Certificate		194	194	
CardCertificate		194	194	{00..00}
EF CA_Certificate		194	194	
MemberStateCertificate		194	194	{00..00}
EF Identification		143	143	
CardIdentification		65	65	
cardIssuingMemberState		1	1	{00}
cardNumber		16	16	{20..20}
cardIssuingAuthorityName		36	36	{20..20}
cardIssueDate		4	4	{00..00}
cardValidityBegin		4	4	{00..00}
cardExpiryDate		4	4	{00..00}
DriverCardHolderIdentification		78	78	
cardHolderName		72	72	
holderSurname		36	36	{00, 20..20}
holderFirstNames		36	36	{00, 20..20}
cardHolderBirthDate		4	4	{00..00}
cardHolderPreferredLanguage		2	2	{20 20}

EF Card_Download		4	4	
└LastCardDownload		4	4	
EF Driving_Licence_Info		53	53	
└CardDrivingLicenceInformation		53	53	
└└drivingLicenceIssuingAuthority		36	36	{00, 20..20}
└└drivingLicenceIssuingNation		1	1	{00}
└└drivingLicenceNumber		16	16	{20..20}
EF Events_Data		864	1728	
└CardEventData		864	1728	
└└cardEventRecords	6	144	288	
└└└CardEventRecord	n <sub>1</sub>	24	24	
└└└└eventType		1	1	{00}
└└└└eventBeginTime		4	4	{00..00}
└└└└eventEndTime		4	4	{00..00}
└└└└eventVehicleRegistration				
└└└└└vehicleRegistrationNation		1	1	{00}
└└└└└vehicleRegistrationNumber		14	14	{00, 20..20}
EF Faults_Data		576	1152	
└CardFaultData		576	1152	
└└cardFaultRecords	2	288	576	
└└└CardFaultRecord	n <sub>2</sub>	24	24	
└└└└faultType		1	1	{00}
└└└└faultBeginTime		4	4	{00..00}
└└└└faultEndTime		4	4	{00..00}
└└└└faultVehicleRegistration				
└└└└└vehicleRegistrationNation		1	1	{00}
└└└└└vehicleRegistrationNumber		14	14	{00, 20..20}
EF Driver_Activity_Data		5548	13780	
└CardDriverActivity		5548	13780	
└└activityPointerOldestDayRecord		2	2	{00 00}
└└activityPointerNewestRecord		2	2	{00 00}
└└activityDailyRecords	n <sub>6</sub>	5544	13776	{00..00}
EF Vehicles_Used		2606	6202	
└CardVehiclesUsed		2606	6202	
└└vehiclePointerNewestRecord		2	2	{00 00}
└└└cardVehicleRecords		2604	6200	
└└└└CardVehicleRecord	n <sub>3</sub>	31	31	
└└└└└vehicleOdometerBegin		3	3	{00..00}
└└└└└vehicleOdometerEnd		3	3	{00..00}
└└└└└vehicleFirstUse		4	4	{00..00}
└└└└└vehicleLastUse		4	4	{00..00}
└└└└└vehicleRegistration				
└└└└└└vehicleRegistrationNation		1	1	{00}
└└└└└└vehicleRegistrationNumber		14	14	{00, 20..20}
└└└└vuDataBlockCounter		2	2	{00 00}
EF Places		841	1121	
└CardPlaceDailyWorkPeriod		841	1121	
└└placePointerNewestRecord		1	1	{00}
└└└placeRecords		840	1120	
└└└└PlaceRecord	n <sub>4</sub>	10	10	
└└└└└entryTime		4	4	{00..00}
└└└└└entryTypeDailyWorkPeriod		1	1	{00}
└└└└└dailyWorkPeriodCountry		1	1	{00}
└└└└└dailyWorkPeriodRegion		1	1	{00}
└└└└└vehicleOdometerValue		3	3	{00..00}
EF Current_Usage		19	19	
└CardCurrentUse		19	19	
└└sessionOpenTime		4	4	{00..00}
└└sessionOpenVehicle				
└└└vehicleRegistrationNation		1	1	{00}
└└└vehicleRegistrationNumber		14	14	{00, 20..20}
EF Control_Activity_Data		46	46	
└CardControlActivityDataRecord		46	46	
└└controlType		1	1	{00}
└└controlTime		4	4	{00..00}
└└controlCardNumber				
└└└cardType		1	1	{00}
└└└cardIssuingMemberState		1	1	{00}
└└└cardNumber		16	16	{20..20}
└└controlVehicleRegistration				
└└└vehicleRegistrationNation		1	1	{00}
└└└vehicleRegistrationNumber		14	14	{00, 20..20}
└└controlDownloadPeriodBegin		4	4	{00..00}
└└controlDownloadPeriodEnd		4	4	{00..00}
EF Specific_Conditions		280	280	
└SpecificConditionRecord	56	5	5	
└└entryTime		4	4	{00..00}
└└SpecificConditionType		1	1	{00}



TCS\_404 The following values, used to provide sizes in the table above, are the minimum and maximum record number values the driver card data structure must use:

		Min	Max
n <sub>1</sub>	NoOfEventsPerType	6	12
n <sub>2</sub>	NoOfFaultsPerType	12	24
n <sub>3</sub>	NoOfCardVehicleRecords	84	200
n <sub>4</sub>	NoOfCardPlaceRecords	84	112
n <sub>6</sub>	CardActivityLengthRange	5 544 bytes (28 days * 93 activity changes)	13 776 bytes (28 days * 240 activity changes)

#### 4.2. Workshop card structure

TCS\_405 After its personalisation, the workshop card shall have the following permanent file structure and file access conditions:

File	File ID	Access conditions		
		Read	Update	Encrypted
MF	3F00			
EF ICC	0002	ALW	NEV	No
EF IC	0005	ALW	NEV	No
DF Tachograph	0500			
EF Application_Identification	0501	ALW	NEV	No
EF Card_Certificate	C100	ALW	NEV	No
EF CA_Certificate	C108	ALW	NEV	No
EF Identification	0520	ALW	NEV	No
EF Card_Download	0509	ALW	ALW	No
EF Calibration	050A	ALW	PRO SM / AUT	No
EF Sensor_Installation_Data	050B	ALW	NEV	Yes
EF Events_Data	0502	ALW	PRO SM / AUT	No
EF Faults_Data	0503	ALW	PRO SM / AUT	No
EF Driver_Activity_Data	0504	ALW	PRO SM / AUT	No
EF Vehicles_Used	0505	ALW	PRO SM / AUT	No
EF Places	0506	ALW	PRO SM / AUT	No
EF Current_Usage	0507	ALW	PRO SM / AUT	No
EF Control_Activity_Data	0508	ALW	PRO SM / AUT	No
EF Specific_Conditions	0522	ALW	PRO SM / AUT	No

TCS\_406 All EFs structures shall be transparent.

TCS\_407 Read with secure messaging shall be possible for all files under the DF Tachograph.

TCS\_408 The workshop card shall have the following data structure:

File/Data element	No of Records	Size (Bytes)		Default Values
		Min	Max	
MF	11088	29061		
EF ICC	25	25		
CardIccIdentification	25	25		
clockStop	1	1		{00}
cardExtendedSerialNumber	8	8		{00..00}
cardApprovalNumber	8	8		{20..20}
cardPersonaliserID	1	1		{00}
embedderIcAssemblerId	5	5		{00..00}
icIdentifier	2	2		{00 00}
EF IC	8	8		
CardChipIdentification	8	8		
icSerialNumber	4	4		{00..00}
icManufacturingReferences	4	4		{00..00}
DF Tachograph	11055	29028		
EF Application_Identification	11	11		
WorkshopCardApplicationIdentification	11	11		
typeOfTachographCardId	1	1		{00}
cardStructureVersion	2	2		{00 00}
noOfEventsPerType	1	1		{00}
noOfFaultsPerType	1	1		{00}
activityStructureLength	2	2		{00 00}
noOfCardVehicleRecords	2	2		{00 00}
noOfCardPlaceRecords	1	1		{00}
noOfCalibrationRecords	1	1		{00}

EF Card_Certificate	194	194	
CardCertificate	194	194	{00..00}
EF CA_Certificate	194	194	
MemberStateCertificate	194	194	{00..00}
EF Identification	211	211	
CardIdentification	65	65	
cardIssuingMemberState	1	1	{00}
cardNumber	16	16	{20..20}
cardIssuingAuthorityName	36	36	{00, 20..20}
cardIssueDate	4	4	{00..00}
cardValidityBegin	4	4	{00..00}
cardExpiryDate	4	4	{00..00}
WorkshopCardHolderIdentification	146	146	
workshopName	36	36	{00, 20..20}
workshopAddress	36	36	{00, 20..20}
cardHolderName			
holderSurname	36	36	{00, 20..20}
holderFirstNames	36	36	{00, 20..20}
cardHolderPreferredLanguage	2	2	{20 20}
EF Card_Download	2	2	
NoOfCalibrationsSinceDownload	2	2	{00 00}
EF Calibration	9243	26778	
WorkshopCardCalibrationData	9243	26778	
calibrationTotalNumber	2	2	{00 00}
calibrationPointerNewestRecord	1	1	{00}
calibrationRecords	9240	26775	
WorkshopCardCalibrationRecord	n <sub>5</sub>	105	105
calibrationPurpose	1	1	{00}
vehicleIdentificationNumber	17	17	{20..20}
vehicleRegistration			
vehicleRegistrationNation	1	1	{00}
vehicleRegistrationNumber	14	14	{00, 20..20}
wVehicleCharacteristicConstant	2	2	{00 00}
kConstantOfRecordingEquipment	2	2	{00 00}
lTyreCircumference	2	2	{00 00}
tyreSize	15	15	{20..20}
authorisedSpeed	1	1	{00}
oldOdometerValue	3	3	{00..00}
newOdometerValue	3	3	{00..00}
oldTimeValue	4	4	{00..00}
newTimeValue	4	4	{00..00}
nextCalibrationDate	4	4	{00..00}
vuPartNumber	16	16	{20..20}
vuSerialNumber	8	8	{00..00}
sensorSerialNumber	8	8	{00..00}
EF Sensor_Installation_Data	16	16	
SensorInstallationSecData	16	16	{00..00}
EF Events_Data	432	432	
CardEventData	432	432	
cardEventRecords	6	72	72
CardEventRecord	n <sub>1</sub>	24	24
eventType	1	1	{00}
eventBeginTime	4	4	{00..00}
eventEndTime	4	4	{00..00}
eventVehicleRegistration			
vehicleRegistrationNation	1	1	{00}
vehicleRegistrationNumber	14	14	{00, 20..20}
EF Faults_Data	288	288	
CardFaultData	288	288	
cardFaultRecords	2	144	144
CardFaultRecord	n <sub>2</sub>	24	24
faultType	1	1	{00}
faultBeginTime	4	4	{00..00}
faultEndTime	4	4	{00..00}
faultVehicleRegistration			
vehicleRegistrationNation	1	1	{00}
vehicleRegistrationNumber	14	14	{00, 20..20}
EF Driver_Activity_Data	202	496	
CardDriverActivity	202	496	
activityPointerOldestDayRecord	2	2	{00 00}
activityPointerNewestRecord	2	2	{00 00}
activityDailyRecords	n <sub>6</sub>	198	492
EF Vehicles_Used	126	250	
CardVehiclesUsed	126	250	
vehiclePointerNewestRecord	2	2	{00 00}
cardVehicleRecords	124	248	
CardVehicleRecord	n <sub>3</sub>	31	31
vehicleOdometerBegin	3	3	{00..00}

vehicleOdometerEnd	3	3	{00..00}
vehicleFirstUse	4	4	{00..00}
vehicleLastUse	4	4	{00..00}
vehicleRegistration			
vehicleRegistrationNation	1	1	{00}
vehicleRegistrationNumber	14	14	{00, 20..20}
vuDataBlockCounter	2	2	{00 00}
<b>EF Places</b>	<b>61</b>	<b>81</b>	
CardPlaceDailyWorkPeriod	61	81	
placePointerNewestRecord	1	1	{00}
placeRecords	60	80	
PlaceRecord	n <sub>4</sub>	10	10
entryTime	4	4	{00..00}
entryTypeDailyWorkPeriod	1	1	{00}
dailyWorkPeriodCountry	1	1	{00}
dailyWorkPeriodRegion	1	1	{00}
vehicleOdometerValue	3	3	{00..00}
<b>EF Current_Usage</b>	<b>19</b>	<b>19</b>	
CardCurrentUse	19	19	
sessionOpenTime	4	4	{00..00}
sessionOpenVehicle			
vehicleRegistrationNation	1	1	{00}
vehicleRegistrationNumber	14	14	{00, 20..20}
<b>EF Control_Activity_Data</b>	<b>46</b>	<b>46</b>	
CardControlActivityDataRecord	46	46	
controlType	1	1	{00}
controlTime	4	4	{00..00}
controlCardNumber			
cardType	1	1	{00}
cardIssuingMemberState	1	1	{00}
cardNumber	16	16	{20..20}
controlVehicleRegistration			
vehicleRegistrationNation	1	1	{00}
vehicleRegistrationNumber	14	14	{00, 20..20}
controlDownloadPeriodBegin	4	4	{00..00}
controlDownloadPeriodEnd	4	4	{00..00}
<b>EF Specific_Conditions</b>	<b>10</b>	<b>10</b>	
SpecificConditionRecord	2	5	5
entryTime	4	4	{00..00}
SpecificConditionType	1	1	{00}

TCS\_409 The following values, used to provide sizes in the table above, are the minimum and maximum record number values the workshop card data structure must use:

		Min	Max
n <sub>1</sub>	NoOfEventsPerType	3	3
n <sub>2</sub>	NoOfFaultsPerType	6	6
n <sub>3</sub>	NoOfCardVehicleRecords	4	8
n <sub>4</sub>	NoOfCardPlaceRecords	6	8
n <sub>6</sub>	CardActivityLengthRange	88	255
n <sub>5</sub>	NoOfCalibrationRecords	198 bytes (1 day * 93 activity changes)	492 bytes (1 day * 240 activity changes)

#### 4.3. Control card structure

TCS\_410 After its personalisation, the control card shall have the following permanent file structure and file access conditions:

File	File ID	Access conditions		
		Read	Update	Encrypted
MF	3F00			
EF ICC	0002	ALW	NEV	No
EF IC	0005	ALW	NEV	No
DF Tachograph	0500			
EF Application_Identification	0501	ALW	NEV	No
EF Card_Certificate	C100	ALW	NEV	No
EF CA_Certificate	C108	ALW	NEV	No
EF Identification	0520	AUT	NEV	No
EF Controller_Activity_Data	050C	ALW	PRO SM / AUT	No

TCS\_411 All EFs structures shall be transparent.

TCS\_412 Read with secure messaging shall be possible for files under the DF Tachograph.

TCS\_413 The control card shall have the following data structure:

Archivo/Elemento de datos	No of Records	Size (Bytes)		Default Values
		Min	Max	
<b>MF</b>		<b>11219</b>	<b>24559</b>	
EF ICC		25	25	
CardIccIdentification		25	25	
clockStop		1	1	{00}
cardExtendedSerialNumber		8	8	{00..00}
cardApprovalNumber		8	8	{20..20}
cardPersonaliserID		1	1	{00}
embedderIcAssemblerId		5	5	{00..00}
icIdentifier		2	2	{00 00}
EF IC		8	8	
CardChipIdentification		8	8	
icSerialNumber		4	4	{00..00}
icManufacturingReferences		4	4	{00..00}
<b>DF Tachograph</b>		<b>11186</b>	<b>24526</b>	
EF Application_Identification		5	5	
ControlCardApplicationIdentification		5	5	
typeOfTachographCardId		1	1	{00}
cardStructureVersion		2	2	{00 00}
noOfControlActivityRecords		2	2	{00 00}
EF Card_Certificate		194	194	
CardCertificate		194	194	{00..00}
EF CA_Certificate		194	194	
MemberStateCertificate		194	194	{00..00}
EF Identification		211	211	
CardIdentification		65	65	
cardIssuingMemberState		1	1	{00}
cardNumber		16	16	{20..20}
cardIssuingAuthorityName		36	36	{00, 20..20}
cardIssueDate		4	4	{00..00}
cardValidityBegin		4	4	{00..00}
cardExpiryDate		4	4	{00..00}
ControlCardHolderIdentification		146	146	
controlBodyName		36	36	{00, 20..20}
controlBodyAddress		36	36	{00, 20..20}
cardHolderName				
holderSurname		36	36	{00, 20..20}
holderFirstNames		36	36	{00, 20..20}
cardHolderPreferredLanguage		2	2	{20 20}
EF Controller_Activity_Data		10582	23922	
ControlCardControlActivityData		10582	23922	
controlPointerNewestRecord		2	2	{00 00}
controlActivityRecords		10580	23920	
controlActivityRecord	n <sub>7</sub>	46	46	
controlType		1	1	{00}
controlTime		4	4	{00..00}
controlledCardNumber				
cardType		1	1	{00}
cardIssuingMemberState		1	1	{00}
cardNumber		16	16	{20..20}
controlledVehicleRegistration				
vehicleRegistrationNation		1	1	{00}
vehicleRegistrationNumber		14	14	{00, 20..20}
controlDownloadPeriodBegin		4	4	{00..00}
controlDownloadPeriodEnd		4	4	{00..00}

TCS\_414 The following values, used to provide sizes in the table above, are the minimum and maximum record number values the control card data structure must use:

		Min	Max
n <sub>7</sub>	NoOfControlActivityRecords	230	520

#### 4.4. Company card structure

TCS\_415 After its personalisation, the company card shall have the following permanent file structure and file access conditions:

File	File ID	Access conditions		
		Read	Update	Encrypted
MF	3F00			
EF ICC	0002	ALW	NEV	No
EF IC	0005	ALW	NEV	No
DF Tachograph	0500			
EF Application_Identification	0501	ALW	NEV	No
EF Card_Certificate	C100	ALW	NEV	No
EF CA_Certificate	C108	ALW	NEV	No
EF Identification	0520	AUT	NEV	No
EF Company_Activity_Data	050D	ALW	PRO SM / AUT	No

TCS\_416 All EFs structures shall be transparent.

TCS\_417 Read with secure messaging shall be possible for all files under the DF Tachograph.

TCS\_418 The company card shall have the following data structure:

File/Data element	No of Records	Size (bytes)		Default Values
		Min	Max	
MF		11147	24487	
EF ICC		25	25	
CardIccIdentification		25	25	
clockStop		1	1	{00}
cardExtendedSerialNumber		8	8	{00..00}
cardApprovalNumber		8	8	{20..20}
cardPersonaliserID		1	1	{00}
embedderIcAssemblerId		5	5	{00..00}
icIdentifier		2	2	{00 00}
EF IC		8	8	
CardChipIdentification		8	8	
icSerialNumber		4	4	{00..00}
icManufacturingReferences		4	4	{00..00}
DF Tachograph		11114	24454	
EF Application_Identification		5	5	
CompanyCardApplicationIdentification		5	5	
typeOfTachographCardId		1	1	{00}
cardStructureVersion		2	2	{00 00}
noOfCompanyActivityRecords		2	2	{00 00}
EF Card_Certificate		194	194	
CardCertificate		194	194	{00..00}
EF CA_Certificate		194	194	
MemberStateCertificate		194	194	{00..00}
EF Identification		139	139	
CardIdentification		65	65	
cardIssuingMemberState		1	1	{00}
cardNumber		16	16	{20..20}
cardIssuingAuthorityName		36	36	{00, 20..20}
cardIssueDate		4	4	{00..00}
cardValidityBegin		4	4	{00..00}
cardExpiryDate		4	4	{00..00}
CompanyCardHolderIdentification		74	74	
companyName		36	36	{00, 20..20}
companyAddress		36	36	{00, 20..20}
cardHolderPreferredLanguage		2	2	{20 20}
EF Company_Activity_Data		10582	23922	
CompanyActivityData		10582	23922	
companyPointerNewestRecord		2	2	{00 00}
companyActivityRecords		10580	23920	
companyActivityRecord	n <sub>8</sub>	46	46	
companyActivityType		1	1	{00}
companyActivityTime		4	4	{00..00}
cardNumberInformation				
cardType		1	1	{00}
cardIssuingMemberState		1	1	{00}
cardNumber		16	16	{20..20}
vehicleRegistrationInformation				
vehicleRegistrationNation		1	1	{00}
vehicleRegistrationNumber		14	14	{00, 20..20}

cardNumberInformation			
cardType	1	1	{00}
cardIssuingMemberState	1	1	{00}
cardNumber	16	16	{20..20}
downloadPeriodBegin	4	4	{00..00}
downloadPeriodEnd	4	4	{00..00}

TCS\_419 The following values, used to provide sizes in the table above, are the minimum and maximum record number values the company card data structure must use:



































		Min	Max
ng	NoOfCompanyActivityRecords	230	520

*Appendix 3*









**PICTOGRAMS**

PIC\_001 The recording equipment may use the following pictograms and pictograms combinations:

## 1. BASIC PICTOGRAMS

	<b>People</b>	<b>Actions</b>	<b>Modes of operation</b>
	Company		Company mode
	Controller	Control	Control mode
	Driver	Driver	Operational mode
	Workshop/test station	Inspection/calibration	Calibration mode
	Manufacturer		
	<b>Activities</b>	<b>Duration</b>	
	Available	Current availability period	
	Driving	Continuous driving time	
	Rest	Current rest period	
	Work	Current work period	
	Break	Cumulative break time	
	Unknown		
	<b>Equipment</b>	<b>Functions</b>	
	Driver slot		
	Co-driver slot		
	Card		
	Clock		
	Display	Displaying	
	External storage	Downloading	
	Power supply		
	Printer/printout	Printing	
	Sensor		
	Tyre size		
	Vehicle/vehicle unit		
	<b>Specific conditions</b>		
	Out of scope		
	Ferry/train crossing		
	<b>Miscellaneous</b>		
	Events		Faults
	Start of daily work period		End of daily work period
	Location		Manual entry of driver activities
	Security		Speed
	Time		Total/summary
	<b>Qualifiers</b>		
24h	Daily		
	Weekly		
	Two weeks		
+	From or to		

## 2. PICTOGRAM COMBINATIONS

<b>Miscellaneous</b>			
	Control place		Location end of daily work period
	Location start of daily work period		To time
	From time		
	From vehicle		
	Out of scope begin		Out of scope end



**Cards**

	Driver card
	Company card
	Control card
	Workshop card
	No card

**Driving**

	Crew driving
	Driving time for one week
	Driving time for two weeks

**Printouts**

	24h Driver activities from card daily printout
	24h Driver activities from VU daily printout
	! x Events and faults from card printout
	! x A Events and faults from VU printout
	T Technical data printout
	>> Over speeding printout

**Events**

	! Card	Insertion of a non valid card
	! C	Card conflict
	! C C	Time overlap
	! C	Driving without an appropriate card
	! C	Card insertion while driving
	! C A	Last card session not correctly closed
	>>	Over speeding
	! +	Power supply interruption
	! n	Motion data error
	! B	Security breach
	! G	Time adjustment (by workshop)
	>> C	Over speeding control

**Faults**

	x C1	Card fault (driver slot)
	x C2	Card fault (co-driver slot)
	x D	Display fault
	x T	Downloading fault
	x P	Printer fault
	x S	Sensor fault
	x A	VU internal fault

**Manual entries procedure**

	! ? P	Still same daily work period?
	! ?	End of previous work period?
	! C ?	Confirm or enter location of end of work period
	! P ?	Enter start time
	! P ?	Enter location of start of work period.

Note: Additional pictogram combinations to form printout block or record identifiers are defined in Appendix 4.

*Appendix 4***PRINTOUTS**

## CONTENTS

1.	Generalities .....	131
2.	Data blocks specification .....	131
3.	Printout specifications .....	137
3.1.	Driver activities from card daily printout .....	138
3.2.	Driver activities from VU daily printout .....	138
3.3.	Events and faults from card printout .....	139
3.4.	Events and faults from VU printout .....	139
3.5.	Technical data printout .....	140
3.6.	Over speeding printout .....	140



2. **Type of printout**  
Block identifier  
Printout pictogram combination (see App. 3), Speed limiting device setting (Over speeding printout only).
3. **Card holder identification**  
Block identifier. P = people pictogram  
Card holder surname  
Card holder first name(s) (if any)  
Card identification  
Card expiry date (if any)  
In the case where the card is a non-personal card, and holds no card holder surname, the company or workshop or control body name shall be printed instead.
4. **Vehicle identification**  
Block identifier  
(VIN)  
Registering Member State and VRN.
5. **VU identification**  
Block identifier  
VU manufacturer's name  
VU part number.
6. **Last calibration of the recording equipment**  
Block identifier  
Workshop name  
Workshop card identification  
Date of the calibration.
7. **Last control (by a control officer)**  
Block identifier  
Controller's card identification  
Control date, time and type  
Type of the control: Up to four pictograms. The type of control can be (a combination) of:  
■: Card downloading, ▴: VU downloading, ▾: printing, □: Displaying.
8. **Driver activities stored on a card in order of occurrence**  
Block identifier  
Enquiry date (calendar day subject of the printout) + Daily card presence counter.
- 8.1. *Period during which the card was not inserted*
- 8.1a. Record identifier (start of period)
- 8.1b. *Unknown period.* Start and end time, duration
- 8.1c. *Activity manually entered*  
Activity pictogram, start and end time (included), duration, rest periods of at least one hour are tagged with a star.

```
-----▾-----
Picto xxx km/h
```

```
-----P-----
P Last_Name _____
  First_Name _____
Card_Identification _____
  dd/mm/yyyy
```

```
-----A-----
A VIN _____
  Nat/VRN _____
```

```
-----B-----
B VU_Manufacturer _____
  VU_Part_Number _____
```

```
-----▴-----
▴ Last_Name _____
Card_Identification _____
▴ dd/mm/yyyy
```

```
-----□-----
Card_Identification _____
□ dd/mm/yyyy hh:mm pppp
```

```
-----□-----
dd/mm/yyyy xxx
```

```
-----
? hh:mm hh:mm hh:mm
A hh:mm hh:mm hh:mm *
```

- 8.2. *Card insertion in slot S*  
Record identifier; S = Slot pictogram  
Vehicle registering Member State and VRN  
Vehicle odometer at card insertion.
- ```
-----S-----
A Nat/VRN _____
  x xxx xxx km
```
- 8.3. *Activity (while card was inserted)*  
Activity pictogram, start and end time (included), duration,  
crew status (crew pictogram if CREW, blanks if SINGLE), rest  
periods of at least one hour are tagged with a star.
- ```
A hh:mm hh:mm hh:mm CC *
```
- 8.3a. *Specific condition. Time of entry, specific condition pictogram  
(or pictogram combination).*
- ```
hh:mm ----- pppp -----
```
- 8.4. *Card withdrawal*  
Vehicle odometer and distance travelled since last insertion  
for which odometer is known.
- ```
x xxx xxx km; x xxx km
```
9. **Driver activities stored in a VU per slot in  
chronological order**  
Block identifier  
Enquiry date (calendar day subject of the printout)  
Vehicle odometer at 00:00 and 24:00.
- ```
-----C-----
      dd/mm/yyyy
x xxx xxx - x xxx xxx km
```
10. **Activities carried in slot S**  
Block identifier.
- ```
----- S -----
```
- 10.1. *Period where no card is inserted in slot S*  
Record identifier  
No Card inserted  
Vehicle odometer at beginning of period.
- ```
-----
CC ---
  x xxx xxx km
```
- 10.2. *Card insertion*  
Card insertion record identifier  
Driver's name  
Driver's first name  
Driver's Card identification  
Driver's card expiry date  
Registering MS and VRN of previous vehicle used  
Date and time of card withdrawal from previous vehicle  
Blank line  
Vehicle odometer at card insertion, manual entry of driver  
activities flag (M if yes, blank if No).
- ```
-----
C Last_Name _____
  First_Name _____
Card_Identification _____
  dd/mm/yyyy
A + Nat/VRN _____

  dd/mm/yyyy hh:mm

  x xxx xxx km      M
```
- 10.3. *Activity*  
Activity pictogram, start and end time (included), duration,  
crew status (crew pictogram if CREW, blanks if SINGLE),  
rests of at least one hour are tagged with a star.
- ```
A hh:mm hh:mm hh:mm CC *
```



- 11.8. *Activity totals (per driver both slots included)*  
 Total driving duration, distance travelled  
 Total driving duration, distance travelled  
 Total resting duration  
 Total duration of crew activities  
 When a daily printout is required for the current day, daily summary information is computed with available data at the time of the printout.

```

    0 hhhmm x xxx km
    * hhhmm 0 hhhmm
    H hhhmm
    00 hhhmm
    
```

12. **Events and/or faults stored on a card**

- 12.1. Block identifier last 5 "Events and Faults" from a card

```

----- !x0-----
    
```

- 12.2. Block identifier all recorded "Events" on a card

```

----- !0-----
    
```

- 12.3. Block identifier all recorded "Faults" on a card

```

----- x0-----
    
```

- 12.4. *Event and/or Fault record*  
 Record identifier  
 Event/fault pictogram, record purpose, date time of start,  
 Additional event/fault code (if any), duration  
 Registering Member State & VRN of vehicle in which the event or fault occurred.

```

-----
Pic          dd/mm/yyyy hh:mm
!xxx                hhhmm
A Nat/VRN _____
    
```

13. **Events and/or faults stored or on-going in a VU**

- 13.1. Block identifier last 5 "Events and Faults" from VU

```

----- !xA-----
    
```

- 13.2. Block identifier all recorded or on-going "Events" in a VU

```

----- !A-----
    
```

- 13.3. Block identifier all recorded or on-going "Faults" in a VU

```

----- xA-----
    
```

- 13.4. *Event and/or fault record*  
 Record identifier  
 Event/fault pictogram, record purpose, date time of start,  
 Additional event/fault code (if any), No of similar events this day, duration  
 Identification of the cards inserted at start or end of the event or fault (up to 4 lines without repeating twice the same card numbers)  
 Case where no card was inserted  
 The record purpose (p) is a numerical code explaining why the event or fault was recorded, coded in accordance with the data element EventFaultRecordPurpose.

```

-----
Pic (p)  dd/mm/yyyy  hh:mm
!xxx    (xxx)      hhhmm

Card_Identification _____
Card_Identification _____
Card_Identification _____
Card_Identification _____
0-----
    
```

14. **VU Identification**

Block identifier  
 VU manufacturer name  
 VU manufacturer address  
 VU part number  
 VU approval number  
 VU serial number  
 VU year of manufacture  
 VU software version and installation date.

```

-----B-----
B Name _____
  Address _____
  PartNumber _____
  Apprv _____
  S/N _____
  YYYY
  V  xx.xx.xx  dd/mm/yyyy
  
```

15. **Sensor identification**

Block identifier  
 Sensor serial number  
 Sensor approval number  
 Sensor first installation date.

```

-----L-----
L S/N _____
  Apprv _____
  dd/mm/yyyy
  
```

16. **Calibration data**

Block identifier

```

-----T-----
  
```

16.1. *Calibration record*

Record identifier  
 Workshop having performed the calibration  
 Workshop address  
 Workshop card identification  
 Workshop card expiry date  
 Blank line  
 Calibration date + calibration purpose  
 VIN  
 Registering Member State & VRN  
 Characteristic coefficient of vehicle  
 Constant of the recording equipment  
 Effective circumference of wheel tyres  
 Size of tyres mounted  
 Speed limiting device setting  
 Old and new odometer values  
 The calibration purpose (p) is a numerical code explaining why these calibration parameters were recorded, coded in accordance with the data element CalibrationPurpose.

```

-----
T Workshop_name _____
  Workshop_address _____
  Card-Identification _____
  dd/mm/yyyy

T dd/mm/yyyy (p)
A VIN _____
  Nat/VRN _____

w xx xxx Imp/km
k xx xxx Imp/km
l xx xxx mm
• TyreSize _____
> xxx km/h
x xxx xxx - x xxx xxx km
  
```

17. **Time adjustment**

Block identifier

```

-----G-----
  
```

17.1. *Time adjustment record*

Record identifier  
 Old date and time  
 New date and time  
 Workshop having performed the time adjustment  
 Workshop address  
 Workshop card identification  
 Workshop card expiry date.

```

-----
! G dd/mm/yyyy hh:mm
  G dd/mm/yyyy hh:mm
T Workshop_name _____
  Workshop_address _____
  Card_Identification _____
  dd/mm/yyyy
  
```



18. **Most recent event and Fault recorded in the VU**

Block identifier

Most recent event date time

Most recent fault date time.

```
----- ! x A -----
! jj/mm/aaaa hh:mm
x jj/mm/aaaa hh:mm
```

19. **Over speeding control information**

Block identifier

Date and time of last OVER SPEEDING CONTROL

Date/time of first over speeding and number of over speeding events since.

```
----- >> -----
> dd/mm/yyyy hh:mm
>> dd/mm/yyyy hh:mm (nnn)
```

20. **Over speeding record**

20.1. Block identifier "First over speeding after the last calibration"

```
----- >> T -----
```

20.2. Block identifier "The 5 most serious over the last 365 days".

```
----- >> (365) -----
```

20.3. Block identifier "The most serious for each of the last 10 days of occurrence"

```
----- >> (10) -----
```

20.4. Record identifier

Date time and duration

Max and average speeds, No of similar events this day

Driver's surname

Driver's first name(s)

Driver card identification

```
-----
>> dd/mm/yyyy hh:mm hh:mm
xxx km/h xxx km/h (xxx)
☐ Last_Name _____
First_Name _____
Card_Identification _____
```

20.5. If no over speeding record exists in a block.

```
>> - - -
```

21. **Hand-written information**

Block identifier

21.1. Control Place

21.2. Controller's signature

21.3. From time

21.4. To time

21.5. Driver's signature

"Hand-written information" Insert enough blank lines above a hand-written item, to be able to actually write the required information or to put a signature.

```
-----
☐ * .....
☐ .....
☐ + .....
+ ☐ .....
☐ .....
```

3. PRINTOUT SPECIFICATIONS

In this chapter the following notation conventions have been used:

|     |                                                                                        |
|-----|----------------------------------------------------------------------------------------|
| N   | Print block or record number N                                                         |
| N   | Print block or record number N repeated as many times as necessary                     |
| X/Y | Print blocks or records X and/or Y as needed, and repeating as many times as necessary |

### 3.1. Driver activities from card daily printout

PRT\_007 The driver activities from card daily printout shall be in accordance with the following format:

|                                                |                                                                            |
|------------------------------------------------|----------------------------------------------------------------------------|
| 1                                              | Date and time at which the document is printed                             |
| 2                                              | Type of printout                                                           |
| 3                                              | Controller identification (if a control card is inserted in the VU)        |
| 3                                              | Driver identification (from card subject of the printout)                  |
| 4                                              | Vehicle identification (vehicle from which printout is taken)              |
| 5                                              | VU identification (VU from which printout is taken)                        |
| 6                                              | Last calibration of this VU                                                |
| 7                                              | Last control the inspected driver has been subject to                      |
| 8                                              | Driver activities delimiter                                                |
| 8.1a / 8.1b / 8.1c / 8.2 /<br>8.3 / 8.3a / 8.4 | Activities of the driver in order of occurrence                            |
| 11                                             | Daily summary delimiter                                                    |
| 11.4                                           | Places entered in chronological order                                      |
| 11.5                                           | Activity totals                                                            |
| 12.1                                           | Events or faults from card delimiter                                       |
| 12.4                                           | Event/Fault records (Last 5 events or faults stored in the card)           |
| 13.1                                           | Events or faults from VU delimiter                                         |
| 13.4                                           | Event/Fault records (Last 5 events or faults stored or on-going in the VU) |
| 21.1                                           | Control place                                                              |
| 21.2                                           | Controller's signature                                                     |
| 21.5                                           | Driver's signature                                                         |

### 3.2. Driver activities from VU daily printout

PRT\_008 The driver activities from VU daily printout shall be in accordance with the following format:

|                                      |                                                               |
|--------------------------------------|---------------------------------------------------------------|
| 1                                    | Date and time at which the document is printed                |
| 2                                    | Type of printout                                              |
| 3                                    | Card holder identification (for all cards inserted in VU)     |
| 4                                    | Vehicle identification (vehicle from which printout is taken) |
| 5                                    | VU identification (VU from which printout is taken)           |
| 6                                    | Last calibration of this VU                                   |
| 7                                    | Last control on this recording equipment                      |
| 9                                    | Driver activities delimiter                                   |
| 10                                   | Driver slot delimiter (slot 1)                                |
| 10.1 / 10.2 / 10.3 / 10.3a /<br>10.4 | Activities in chronological order (driver slot)               |
| 10                                   | Co-driver slot delimiter (slot 2)                             |
| 10.1 / 10.2 / 10.3 / 10.3a /<br>10.4 | Activities in chronological order (co-driver slot)            |
| 11                                   | Daily summary delimiter                                       |
| 11.1                                 | Summary of periods without card in driver slot                |
| 11.4                                 | Places entered in chronological order                         |
| 11.6                                 | Activity totals                                               |

|      |                                                                            |                                                                                                 |
|------|----------------------------------------------------------------------------|-------------------------------------------------------------------------------------------------|
| 11.2 | Summary of periods without card in co-driver slot                          |                                                                                                 |
| 11.4 | Places entered in chronological order                                      |                                                                                                 |
| 11.7 | Activity totals                                                            |                                                                                                 |
| 11.3 | Summary of activities for a driver both slots included                     |                                                                                                 |
| 11.4 | Places entered by this driver in chronological order                       |                                                                                                 |
| 11.7 | Activity totals for this driver                                            |                                                                                                 |
| 13.1 | Events faults delimiter                                                    |                                                                                                 |
| 13.4 | Event/Fault records (Last 5 events or faults stored or on-going in the VU) |                                                                                                 |
| 21.1 | Control place                                                              |                                                                                                 |
| 21.2 | Controller's signature                                                     |                                                                                                 |
| 21.3 | From time                                                                  | (space available for a driver without a card to indicate which periods are relevant to himself) |
| 21.4 | To time                                                                    |                                                                                                 |
| 21.5 | Driver's signature                                                         |                                                                                                 |

### 3.3. Events and faults from card printout

PRT\_009 The events and faults from card printout shall be in accordance with the following format:

|      |                                                                     |
|------|---------------------------------------------------------------------|
| 1    | Date and time at which the document is printed                      |
| 2    | Type of printout                                                    |
| 3    | Controller identification (if a control card is inserted in the VU) |
| 3    | Driver identification (from card subject of the printout)           |
| 4    | Vehicle identification (vehicle from which printout is taken)       |
| 12.2 | Events delimiter                                                    |
| 12.4 | Event records (all events stored on the card)                       |
| 12.3 | Faults delimiter                                                    |
| 12.4 | Fault records (all faults stored on the card)                       |
| 21.1 | Control place                                                       |
| 21.2 | Controller's signature                                              |
| 21.5 | Driver's signature                                                  |

### 3.4. Events and faults from VU printout

PRT\_010 The events and faults from VU printout shall be in accordance with the following format:

|      |                                                               |
|------|---------------------------------------------------------------|
| 1    | Date and time at which the document is printed                |
| 2    | Type of printout                                              |
| 3    | Card holder identification (for all cards inserted in VU)     |
| 4    | Vehicle identification (vehicle from which printout is taken) |
| 13.2 | Events delimiter                                              |
| 13.4 | Event records (All Events stored or on-going in the VU)       |
| 13.3 | Faults delimiter                                              |
| 13.4 | Fault records (All Faults stored or on-going in the VU)       |
| 21.1 | Control place                                                 |
| 21.2 | Controller's signature                                        |
| 21.5 | Driver's signature                                            |

### 3.5. Technical data printout

PRT\_011 The technical data printout shall be in accordance with the following format:

|      |                                                                                                        |
|------|--------------------------------------------------------------------------------------------------------|
| 1    | Date and time at which the document is printed                                                         |
| 2    | Type of printout                                                                                       |
| 3    | Card holder identification (for all cards inserted in VU)                                              |
| 4    | Vehicle identification (vehicle from which printout is taken)                                          |
| 14   | VU identification                                                                                      |
| 15   | Sensor identification                                                                                  |
| 16   | Calibration data delimiter                                                                             |
| 16.1 | Calibration records (all records available in chronological order)                                     |
| 17   | Time adjustment delimiter                                                                              |
| 17.1 | Time adjustment records (all records available from time adjustment and from calibration data records) |
| 18   | Most recent event and Fault recorded in the VU                                                         |

### 3.6. Over speeding printout

PRT\_012 The over speeding printout shall be in accordance with the following format:

|             |                                                                           |
|-------------|---------------------------------------------------------------------------|
| 1           | Date and time at which the document is printed                            |
| 2           | Type of printout                                                          |
| 3           | Card holder identification (for all cards inserted in VU)                 |
| 4           | Vehicle identification (vehicle from which printout is taken)             |
| 19          | Over speeding control information                                         |
| 20.1        | Over speeding data identifier                                             |
| 20.4 / 20.5 | First over speeding after the last calibration                            |
| 20.2        | Over speeding data identifier                                             |
| 20.4 / 20.5 | The 5 most serious over speeding events over the last 365 days            |
| 20.3        | Over speeding data identifier                                             |
| 20.4 / 20.5 | The most serious over speeding for each of the last 10 days of occurrence |
| 21.1        | Control place                                                             |
| 21.2        | Controller's signature                                                    |
| 21.5        | Driver's signature.                                                       |

*Appendix 5*

**DISPLAY**

In this appendix the following format notation conventions have been used:

- characters printed in **bold** denote plain text to be displayed (display remains in normal character),
  - normal characters denote variables (pictograms or data) to be replaced by their values for displaying:
- dd mm yyyy: day, month, year,  
 hh: hours,  
 mm: minutes,  
 D: duration pictogram,  
 EF: event or fault pictograms combination,  
 O: mode of operation pictogram.

DIS\_001 The recording equipment shall display data using the following formats:

| Data                                                                     | Format                                                       |
|--------------------------------------------------------------------------|--------------------------------------------------------------|
| <b>Default display</b>                                                   |                                                              |
| Local time                                                               | hh:mm                                                        |
| Mode of operation                                                        | O                                                            |
| Information related to the driver                                        | <b>1</b> $\text{Dhhmm}$ <b>  </b> $\text{hhmm}$              |
| Information related to the co-driver                                     | <b>2</b> $\text{Dhhmm}$                                      |
| Out of scope condition opened                                            | <b>OUT</b>                                                   |
| <b>Warning display</b>                                                   |                                                              |
| Exceeding continuous driving time                                        | <b>1</b> $\text{O hhmm}$ <b>  </b> $\text{hhmm}$             |
| Event or fault                                                           | EF                                                           |
| <b>Other displays</b>                                                    |                                                              |
| UTC date                                                                 | UTC $\text{O dd/mm/yyyy}$<br>or<br>UTC $\text{O dd.mm.yyyy}$ |
| time                                                                     | hh:mm                                                        |
| Driver's continuous driving time and cumulative break time               | <b>1</b> $\text{O hhmm}$ <b>  </b> $\text{hhmm}$             |
| Co-driver's continuous driving time and cumulative break time            | <b>2</b> $\text{O hhmm}$ <b>  </b> $\text{hhmm}$             |
| Driver's cumulated driving time for the previous and the current week    | <b>1</b> $\text{O   hhmm}$                                   |
| Co-driver's cumulated driving time for the previous and the current week | <b>2</b> $\text{O   hhmm}$                                   |

*Appendix 6***EXTERNAL INTERFACES**

## CONTENT

|      |                             |     |
|------|-----------------------------|-----|
| 1.   | Hardware .....              | 144 |
| 1.1. | Connector .....             | 144 |
| 1.2. | Contact allocation .....    | 146 |
| 1.3. | Block diagram .....         | 146 |
| 2.   | Downloading Interface ..... | 146 |
| 3.   | Calibration Interface ..... | 147 |

## 1. HARDWARE

## 1.1. Connector

INT\_001 The downloading/calibration connector shall be a six pin connector, accessible on the front panel without the need to disconnect any part of the recording equipment, and shall comply with the following drawing (all dimensions in millimetres):

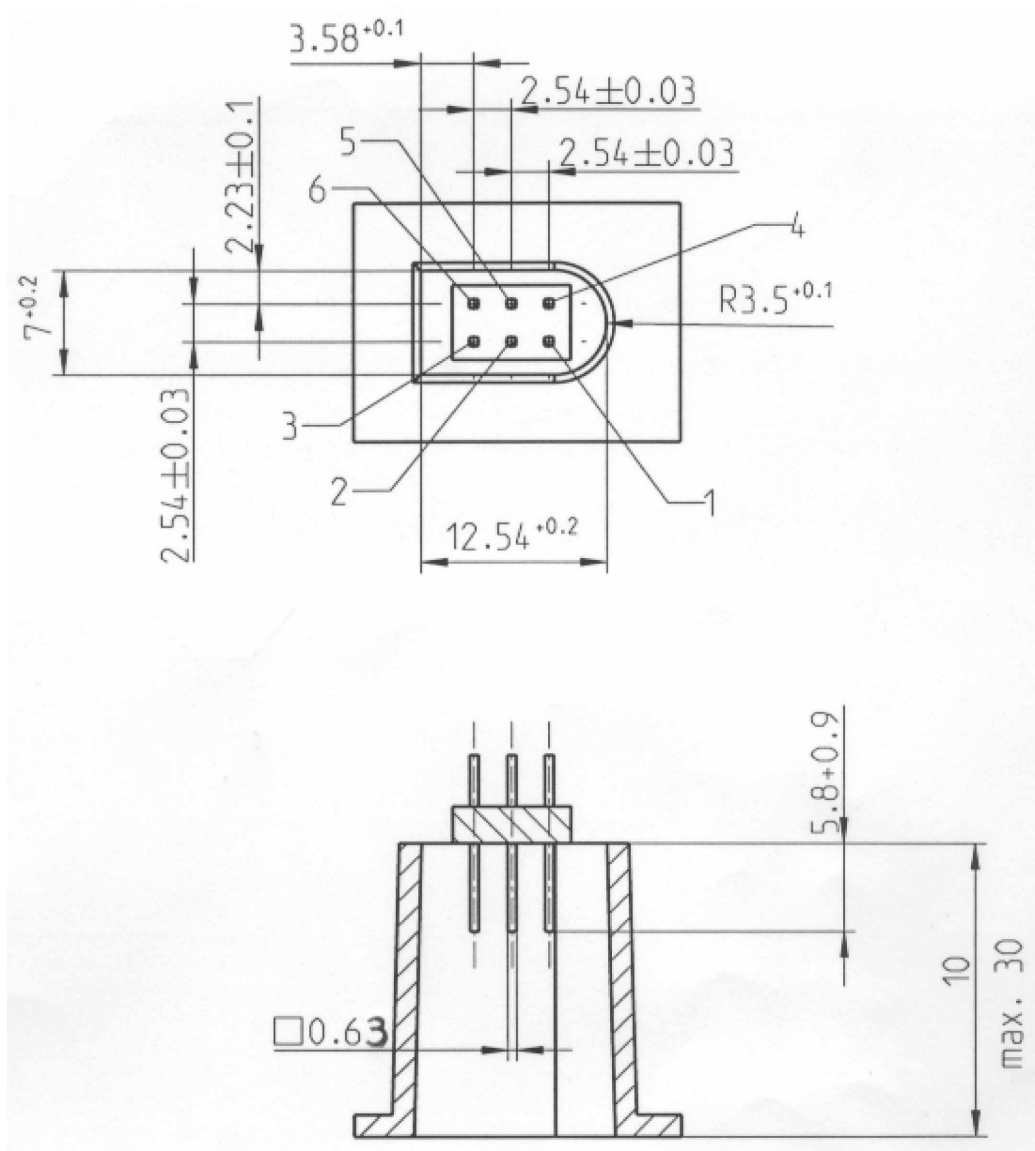



The following diagram shows a typical six pin mating plug:

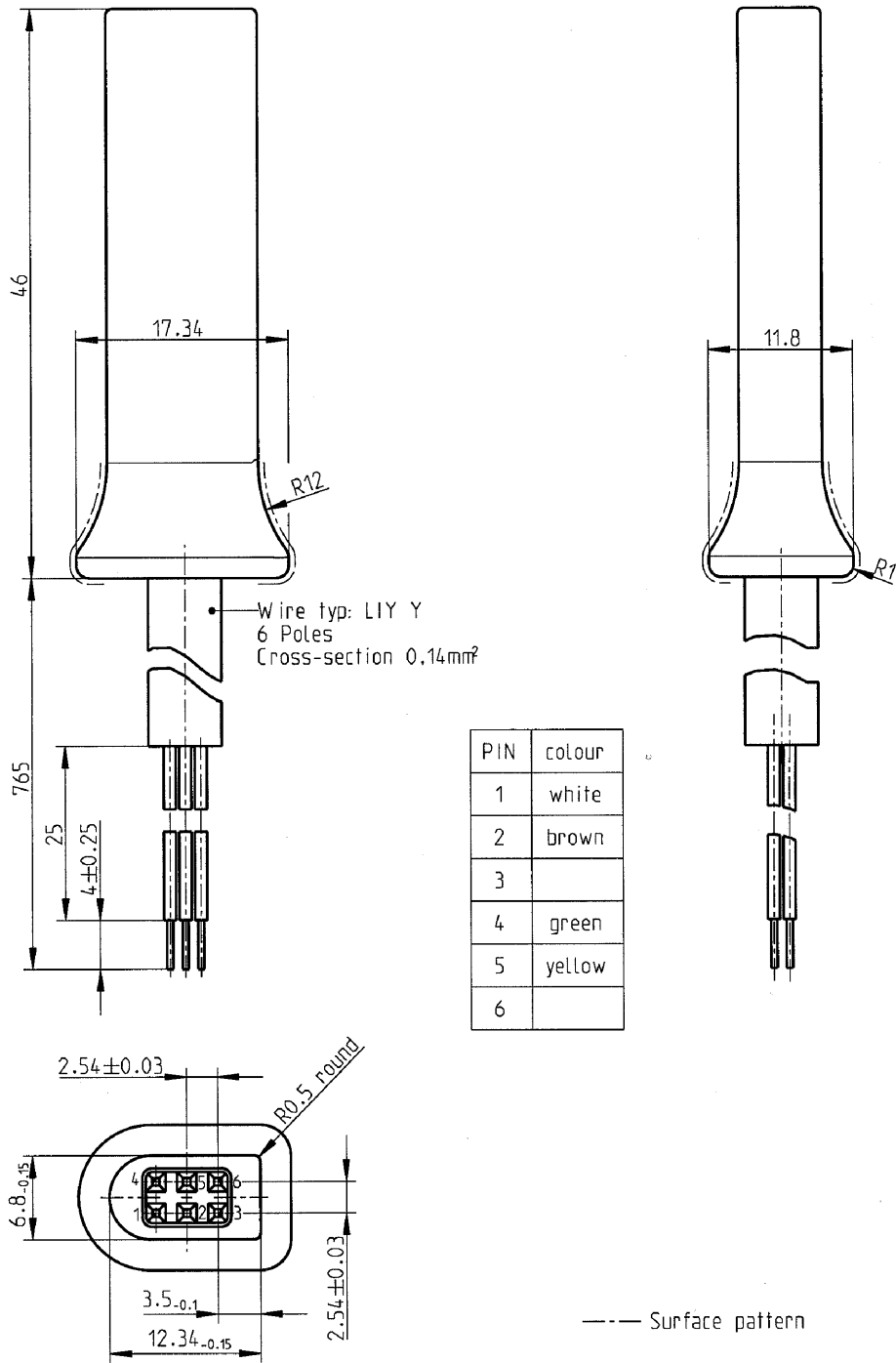

1.2. Contact allocation

INT\_002 Contacts shall be allocated in accordance with the following table:

| Pin | Description            | Remark                                                                                                                                                    |
|-----|------------------------|-----------------------------------------------------------------------------------------------------------------------------------------------------------|
| 1   | Battery minus          | Connected to the battery minus of the vehicle                                                                                                             |
| 2   | Data communication     | K-line (ISO 14 230-1)                                                                                                                                     |
| 3   | RxD — Downloading      | Data input to recording equipment                                                                                                                         |
| 4   | Input/output signal    | Calibration                                                                                                                                               |
| 5   | Permanent power output | The voltage range is specified to be that of the vehicle power minus 3V to allow for the voltage drop across the protective circuitry<br><br>Output 40 mA |
| 6   | TxD — Downloading      | Data output from recording equipment                                                                                                                      |

1.3. Block diagram

INT\_003 The block diagram shall comply with the following:

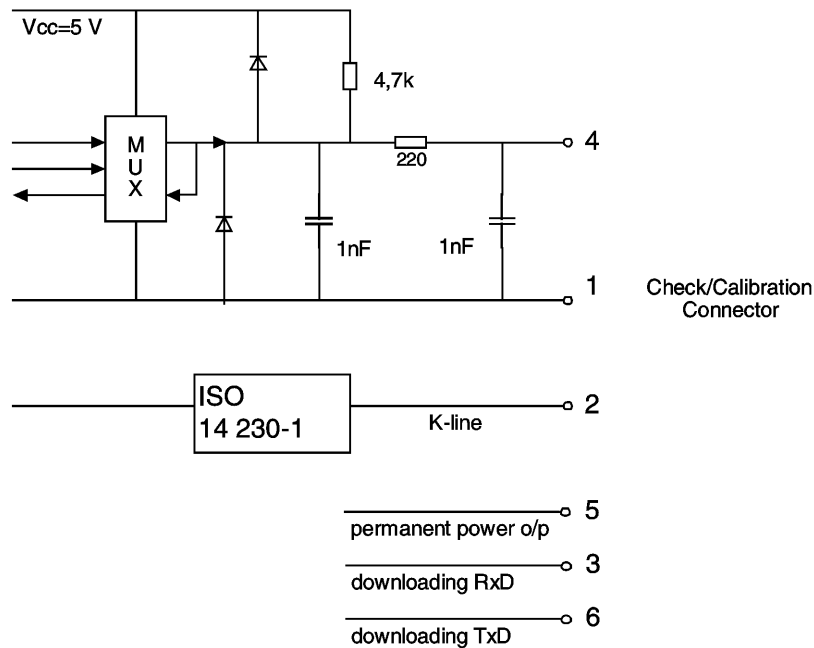

2. DOWNLOADING INTERFACE

INT\_004 The downloading interface shall comply to RS232 specifications.

INT\_005 The downloading interface shall use one start bit, 8 data bits LSB first, one even parity bit and 1 stop bit.

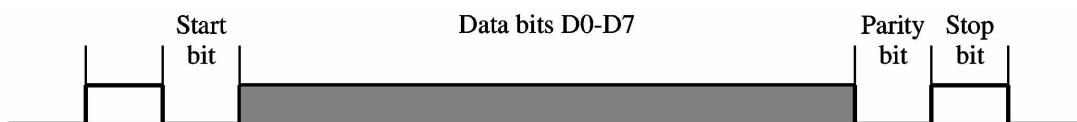

Data byte organisation

- Start bit: one bit with logic level 0
- Data bits: transmitted with LSB first
- Parity bit: even parity
- Stop bit: one bit with logic level 1

When numerical data composed by more than one byte are transmitted, the most significant byte is transmitted first and the least significant byte last.

INT\_006 Transmission baud rates shall be adjustable from 9 600 bps to 115 200 bps. Transmission shall be achieved at the highest possible transmission speed, the initial baud rate after a start of communication being set at 9 600 bps.

### 3. CALIBRATION INTERFACE

INT\_007 The data communication shall comply to ISO 14 230-1 Road vehicles — Diagnostic systems — Keyword protocol 2000 — Part 1: Physical layer, First edition: 1999.

INT\_008 The input/output signal shall comply with the following electrical specification:

| Parameter               | Minimum | Typical | Maximum | Remark                |
|-------------------------|---------|---------|---------|-----------------------|
| $U_{\text{low}}$ (in)   |         |         | 1,0 V   | $I = 750 \mu\text{A}$ |
| $U_{\text{high}}$ (in)  | 4 V     |         |         | $I = 200 \mu\text{A}$ |
| Frequency               |         |         | 4 kHz   |                       |
| $U_{\text{low}}$ (out)  |         |         | 1,0 V   | $I = 1 \text{ mA}$    |
| $U_{\text{high}}$ (out) | 4 V     |         |         | $I = 1 \text{ mA}$    |

INT\_009 The input/output signal shall comply with the following timing diagrams:

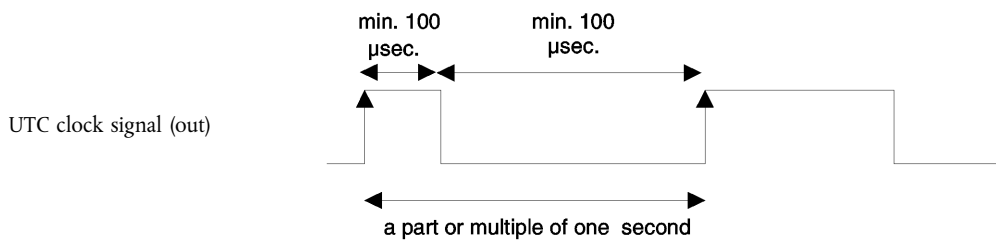
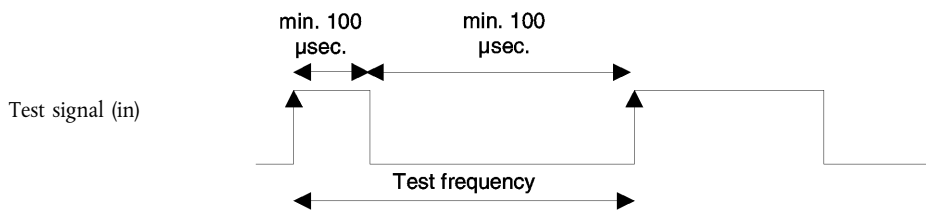
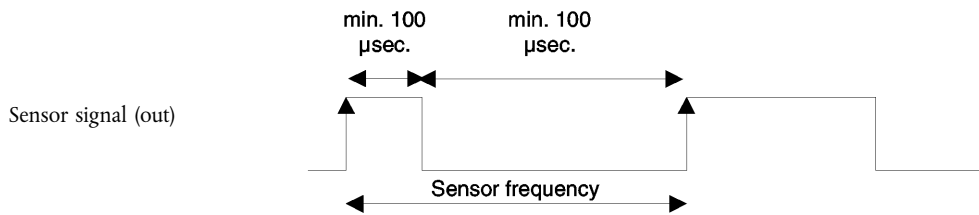

## Appendix 7

**DATA DOWNLOADING PROTOCOLS**

## CONTENTS

|           |                                                         |     |
|-----------|---------------------------------------------------------|-----|
| 1.        | Introduction .....                                      | 150 |
| 1.1.      | Scope .....                                             | 150 |
| 1.2.      | Acronyms and notations .....                            | 150 |
| 2.        | VU data downloading .....                               | 151 |
| 2.1.      | Download procedure .....                                | 151 |
| 2.2.      | Data download protocol .....                            | 151 |
| 2.2.1.    | Message structure .....                                 | 151 |
| 2.2.2.    | Message types .....                                     | 152 |
| 2.2.2.1.  | Start communication request (SID 81) .....              | 154 |
| 2.2.2.2.  | Positive response start communication (SID C1) .....    | 154 |
| 2.2.2.3.  | Start diagnostic session request (SID 10) .....         | 154 |
| 2.2.2.4.  | Positive response start diagnostic (SID 50) .....       | 154 |
| 2.2.2.5.  | Link control service (SID 87) .....                     | 154 |
| 2.2.2.6.  | Link control positive response (SID C7) .....           | 154 |
| 2.2.2.7.  | Request upload (SID 35) .....                           | 154 |
| 2.2.2.8.  | Positive response request upload (SID 75) .....         | 154 |
| 2.2.2.9.  | Transfer data request (SID 36) .....                    | 154 |
| 2.2.2.10. | Positive response transfer data (SID 76) .....          | 155 |
| 2.2.2.11. | Transfer exit request (SID 37) .....                    | 155 |
| 2.2.2.12. | Positive response request transfer exit (SID 77) .....  | 155 |
| 2.2.2.13. | Stop communication request (SID 82) .....               | 155 |
| 2.2.2.14. | Positive response stop communication (SID C2) .....     | 155 |
| 2.2.2.15. | Acknowledge sub message (SID 83) .....                  | 155 |
| 2.2.2.16. | Negative response (SID 7F) .....                        | 155 |
| 2.2.3.    | Message flow .....                                      | 156 |
| 2.2.4.    | Timing .....                                            | 157 |
| 2.2.5.    | Error handling .....                                    | 157 |
| 2.2.5.1.  | Start communication phase .....                         | 157 |
| 2.2.5.2.  | Communication phase .....                               | 157 |
| 2.2.6.    | Response message content .....                          | 160 |
| 2.2.6.1.  | Positive response transfer data overview .....          | 160 |
| 2.2.6.2.  | Positive response transfer data activities .....        | 161 |
| 2.2.6.3.  | Positive response transfer data events and faults ..... | 162 |

---

|          |                                                        |     |
|----------|--------------------------------------------------------|-----|
| 2.2.6.4. | Positive response transfer data detailed speed .....   | 163 |
| 2.2.6.5. | Positive response transfer data technical data .....   | 163 |
| 2.3.     | ESM file storage .....                                 | 164 |
| 3.       | Tachograph cards downloading protocol .....            | 164 |
| 3.1.     | Scope .....                                            | 164 |
| 3.2.     | Definitions .....                                      | 164 |
| 3.3.     | Card downloading .....                                 | 164 |
| 3.3.1.   | Initialisation sequence .....                          | 165 |
| 3.3.2.   | Sequence for un-signed data files .....                | 165 |
| 3.3.3.   | Sequence for signed data files .....                   | 165 |
| 3.3.4.   | Sequence for resetting the calibration counter .....   | 166 |
| 3.4.     | Data storage format .....                              | 166 |
| 3.4.1.   | Introduction .....                                     | 166 |
| 3.4.2.   | File format .....                                      | 166 |
| 4.       | Downloading a tachograph card via a vehicle unit ..... | 167 |

## 1. INTRODUCTION

This appendix specifies the procedures to follow in order to perform the different types of data download to an external storage medium, together with the protocols that must be implemented to assure the correct data transfer and the full compatibility of the downloaded data format to allow any controller to inspect these data and be able to control their authenticity and their integrity before analysing them.

### 1.1. Scope

Data may be downloaded to an ESM:

- from a vehicle unit by an intelligent dedicated equipment (IDE) connected to the VU,
- from a tachograph card by an IDE fitted with a card interface device (IFD),
- from a tachograph card via a vehicle unit by an IDE connected to the VU.

To give the possibility to verify the authenticity and integrity of downloaded data stored on an ESM, data is downloaded with a signature appended in accordance with Appendix 11 Common Security Mechanisms. The source equipment (VU or card) identification and its security certificates (Member State and equipment) are also downloaded. The verifier of the data must possess independently a trusted European public key.

DDP\_001 Data downloaded during one download session must be stored in the ESM within one file.

### 1.2. Acronyms and notations

The following acronyms are used in this appendix:

|      |                                                                                                                     |
|------|---------------------------------------------------------------------------------------------------------------------|
| AID  | application identifier                                                                                              |
| ATR  | answer to reset                                                                                                     |
| CS   | checksum byte                                                                                                       |
| DF   | dedicated file                                                                                                      |
| DS_  | diagnostic session                                                                                                  |
| EF   | elementary file                                                                                                     |
| ESM  | external storage medium                                                                                             |
| FID  | file identifier (File ID)                                                                                           |
| FMT  | format byte (first byte of message header)                                                                          |
| ICC  | integrated circuit card                                                                                             |
| IDE  | intelligent dedicated equipment: The equipment used to perform data downloading to the ESM (e.g. personal computer) |
| IFD  | interface device                                                                                                    |
| KWP  | keyword protocol 2000                                                                                               |
| LEN  | length byte (last byte of message header)                                                                           |
| PPS  | protocol parameter selection                                                                                        |
| PSO  | perform security operation                                                                                          |
| SID  | service identifier                                                                                                  |
| SRC  | source byte                                                                                                         |
| TGT  | target byte                                                                                                         |
| TLV  | tag length value                                                                                                    |
| TREP | transfer response parameter                                                                                         |
| TRTP | transfer request parameter                                                                                          |
| VU   | vehicle unit.                                                                                                       |

## 2. VU DATA DOWNLOADING

### 2.1. Download procedure

In order to carry on a VU data download, the operator must perform the following operations:

- insert his tachograph card inside a card slot of the VU <sup>(1)</sup>,
- connect the IDE to the VU download connector,
- establish the connection between the IDE and the VU,
- select on the IDE the data to download and send the request to the VU,
- close the download session.

### 2.2. Data download protocol

The protocol is structured on a master-slave basis, with the IDE playing the master role and the VU playing the slave role.

The message structure, types and flow are principally based on the Keyword Protocol 2000 (KWP) (ISO 14230-2 Road vehicles — Diagnostic systems — Keyword protocol 2000 — Part 2: Data link layer).

The application layer is principally based on the current draft to date of ISO 14229-1 (Road vehicles — Diagnostic systems — Part 1: Diagnostic services, version 6 of 22 February 2001).

#### 2.2.1. Message structure

DDP\_002 All the messages exchanged between the IDE and the VU are formatted with a structure consisting of three parts:

- header composed by a format byte (FMT), a target byte (TGT), a source byte (SRC) and possibly a length byte (LEN),
- data field composed by a service identifier byte (SID) and a variable number of data bytes, which can include an optional diagnostic session byte (DS\_) or an optional transfer parameter byte (TRTP or TREP).
- checksum composed by a checksum byte (CS).

| Header  |     |     |     | Data field    |      |     |     |     | Checksum |
|---------|-----|-----|-----|---------------|------|-----|-----|-----|----------|
| FMT     | TGT | SRC | LEN | SID           | DATA | ... | ... | ... | CS       |
| 4 bytes |     |     |     | Max 225 bytes |      |     |     |     | 1 byte   |

The TGT and SRC byte represent the physical address of the recipient and originator of the message. Values are F0 Hex for the IDE and EE Hex for the VU.

The LEN byte is the length of the data field part.

The checksum byte is the 8 bit sum series modulo 256 of all the bytes of the message excluding the CS itself.

FMT, SID, DS\_, TRTP and TREP bytes are defined later in this document.

<sup>(1)</sup> The card inserted will trigger the appropriate access rights to the downloading function and to the data.

DDP\_003 In the case where the data to be carried by the message is longer than the space available in the data field part, the message is actually sent in several submessages. Each submessage bears a header, the same SID, TREP and a 2-byte submessage counter indicating the submessage number within the total message. To enable error checking and abort the IDE acknowledges every submessage. The IDE can accept the submessage, ask for it to be re-transmitted, request the VU to start again or abort the transmission.

DDP\_004 If the last submessage contains exactly 255 bytes in the data field, a final submessage with an empty (except SID TREP and submessage counter) data field must be appended to show the end of the message.

Example:

|         |                       |      |         |  |  |    |
|---------|-----------------------|------|---------|--|--|----|
| Header  | SID                   | TREP | Message |  |  | CS |
| 4 Bytes | Longer than 255 Bytes |      |         |  |  |    |

Will be transmitted as:

|         |           |      |    |    |              |    |
|---------|-----------|------|----|----|--------------|----|
| Header  | SID       | TREP | 00 | 01 | Submessage 1 | CS |
| 4 Bytes | 255 Bytes |      |    |    |              |    |

|         |           |      |    |    |              |    |
|---------|-----------|------|----|----|--------------|----|
| Header  | SID       | TREP | 00 | 01 | Submessage 2 | CS |
| 4 Bytes | 255 Bytes |      |    |    |              |    |

...

|         |                     |      |    |    |              |    |
|---------|---------------------|------|----|----|--------------|----|
| Header  | SID                 | TREP | xx | yy | Submessage n | CS |
| 4 Bytes | Less than 255 Bytes |      |    |    |              |    |

or as:

|         |           |      |    |    |              |    |
|---------|-----------|------|----|----|--------------|----|
| Header  | SID       | TREP | 00 | 01 | Submessage 1 | CS |
| 4 Bytes | 255 Bytes |      |    |    |              |    |

|         |           |      |    |    |              |    |
|---------|-----------|------|----|----|--------------|----|
| Header  | SID       | TREP | 00 | 02 | Submessage 2 | CS |
| 4 Bytes | 255 Bytes |      |    |    |              |    |

...

|         |           |      |    |    |              |    |
|---------|-----------|------|----|----|--------------|----|
| Header  | SID       | TREP | xx | yy | Submessage n | CS |
| 4 Bytes | 255 Bytes |      |    |    |              |    |

|         |         |      |    |      |    |
|---------|---------|------|----|------|----|
| Header  | SID     | TREP | xx | yy+1 | CS |
| 4 Bytes | 4 bytes |      |    |      |    |

### 2.2.2. Message types

The communication protocol for data download between the VU and the IDE requires the exchange of eight different message types.

The following table summarises these messages.



| Message Structure                                | Maximum 4 bytes Header |     |     |     | Maximum 255 bytes Data |          |                                    | 1 byte CheckSum |
|--------------------------------------------------|------------------------|-----|-----|-----|------------------------|----------|------------------------------------|-----------------|
|                                                  | FMT                    | TGT | SRC | LEN | SID                    | DS_/TRTP | DATA                               | CS              |
| IDE ->                                           | <- VU                  |     |     |     |                        |          |                                    |                 |
| Start communication request                      | 81                     | EE  | F0  |     | 81                     |          |                                    | E0              |
| Positive response start communication            | 80                     | F0  | EE  | 03  | C1                     |          | 8F,EA                              | 9B              |
| Start diagnostic session request                 | 80                     | EE  | F0  | 02  | 10                     | 81       |                                    | F1              |
| Positive response start diagnostic               | 80                     | F0  | EE  | 02  | 50                     | 81       |                                    | 31              |
| Link control service                             |                        |     |     |     |                        |          |                                    |                 |
| Verify Baud rate (stage 1)                       |                        |     |     |     |                        |          |                                    |                 |
| 9 600 Bd                                         | 80                     | EE  | F0  | 04  | 87                     |          | 01,01,01                           | EC              |
| 19 200 Bd                                        | 80                     | EE  | F0  | 04  | 87                     |          | 01,01,02                           | ED              |
| 38 400 Bd                                        | 80                     | EE  | F0  | 04  | 87                     |          | 01,01,03                           | ED              |
| 57 600 Bd                                        | 80                     | EE  | F0  | 04  | 87                     |          | 01,01,04                           | EF              |
| 115 200 Bd                                       | 80                     | EE  | F0  | 04  | 87                     |          | 01,01,05                           | F0              |
| Positive response verify Baud rate               | 80                     | F0  | EE  | 02  | C7                     |          | 01                                 | 28              |
| Transition baud rate (stage 2)                   | 80                     | EE  | F0  | 03  | 87                     |          | 02,03                              | ED              |
| Request Upload                                   | 80                     | EE  | F0  | 0A  | 35                     |          | 00,00,00,<br>00,00,FF,FF,<br>FF,FF | 99              |
| Positive response request upload                 | 80                     | F0  | EE  | 03  | 75                     |          | 00,FF                              | D5              |
| Transfer data request                            |                        |     |     |     |                        |          |                                    |                 |
| Overview                                         | 80                     | EE  | F0  | 02  | 36                     | 01       |                                    | 97              |
| Activities                                       | 80                     | EE  | F0  | 06  | 36                     | 02       | Date                               | CS              |
| Events and faults                                | 80                     | EE  | F0  | 02  | 36                     | 03       |                                    | 99              |
| Detailed speed                                   | 80                     | EE  | F0  | 02  | 36                     | 04       |                                    | 9A              |
| Technical data                                   | 80                     | EE  | F0  | 02  | 36                     | 05       |                                    | 9B              |
| Card download                                    | 80                     | EE  | F0  | 02  | 36                     | 06       |                                    | 9C              |
| Positive response transfer data                  | 80                     | F0  | EE  | Len | 76                     | TREP     | Data                               | CS              |
| Request transfer exit                            | 80                     | EE  | F0  | 01  | 37                     |          |                                    | 96              |
| Positive response request transfer exit          | 80                     | F0  | EE  | 01  | 77                     |          |                                    | D6              |
| Stop communication request                       | 80                     | EE  | F0  | 01  | 82                     |          |                                    | E1              |
| Positive response stop communication             | 80                     | F0  | EE  | 01  | C2                     |          |                                    | 21              |
| Acknowledge sub message                          | 80                     | EE  | F0  | Len | 83                     |          | Data                               | CS              |
| Negative responses                               |                        |     |     |     |                        |          |                                    |                 |
| General reject                                   | 80                     | F0  | EE  | 03  | 7F                     | Sid Req  | 10                                 | CS              |
| Service not supported                            | 80                     | F0  | EE  | 03  | 7F                     | Sid Req  | 11                                 | CS              |
| Subfunction not supported                        | 80                     | F0  | EE  | 03  | 7F                     | Sid Req  | 12                                 | CS              |
| Incorrect message length                         | 80                     | F0  | EE  | 03  | 7F                     | Sid Req  | 13                                 | CS              |
| Conditions not correct or request sequence error | 80                     | F0  | EE  | 03  | 7F                     | Sid Req  | 22                                 | CS              |
| Request out of range                             | 80                     | F0  | EE  | 03  | 7F                     | Sid Req  | 31                                 | CS              |
| Upload not accepted                              | 80                     | F0  | EE  | 03  | 7F                     | Sid Req  | 50                                 | CS              |
| Response pending                                 | 80                     | F0  | EE  | 03  | 7F                     | Sid Req  | 78                                 | CS              |
| Data not available                               | 80                     | F0  | EE  | 03  | 7F                     | Sid Req  | FA                                 | CS              |

## Notes:

- Sid Req = the Sid of the corresponding request.
- TREP = the TRTP of the corresponding request.
- Dark cells denotes that nothing is transmitted.
- The term upload (as seen from the IDE) is used for compatibility with ISO 14229. It means the same as download (as seen from the VU).
- Potential 2-byte submessage counters are not shown in this Table.

2.2.2.1. *Start communication request (SID 81)*

DDP\_005 This message is issued by the IDE to establish the communication link with the VU. Initial communications are always performed at 9 600 baud (until baud rate is eventually changed using the appropriate Link control services).

2.2.2.2. *Positive response start communication (SID C1)*

DDP\_006 This message is issued by the VU to answer positively to a start communication request. It includes the 2 key bytes '8F' 'EA' indicating that the unit supports protocol with header including target source and length information.

2.2.2.3. *Start diagnostic session request (SID 10)*

DDP\_007 The start diagnostic session request message is issued by the IDE in order to request a new diagnostic session with the VU. The sub function 'default session' (81 Hex) indicates a standard diagnostic session is to be opened.

2.2.2.4. *Positive response start diagnostic (SID 50)*

DDP\_008 The positive response start diagnostic message is sent by the VU to answer positively to Diagnostic Session Request.

2.2.2.5. *Link control service (SID 87)*

DDP\_052 The link control service is used by the IDE to initiate a change in baud rate. This takes place in two steps. In step one the IDE proposes the baud rate change, indicating the new rate. On receipt of a positive message from the VU the IDE sends out confirmation of the baud rate change to the VU (step two). The IDE then changes to the new baud rate. After receipt of the confirmation the VU changes to the new baud rate

2.2.2.6. *Link control positive response (SID C7)*

DDP\_053 The link control positive response is issued by the VU to answer positively to Link Control Service request (step one). Note that no response is given to the confirmation request (step two).

2.2.2.7. *Request upload (SID 35)*

DDP\_009 The request upload message is issued by the IDE to specify to the VU that a download operation is requested. To meet the requirements of ISO14229 data is included covering address, the size and format details for the data requested. As these are not known to the IDE prior to a download, the memory address is set to 0, format is unencrypted and uncompressed and the memory size is set to the maximum.

2.2.2.8. *Positive response request upload (SID 75)*

DDP\_010 The positive response request upload message is sent by the VU to indicate to the IDE that the VU is ready to download data. To meet the requirements of ISO 14229 data is included in this positive response message, indicating to the IDE that further positive response transfer data messages will include 00FF hex bytes maximum.

2.2.2.9. *Transfer data request (SID 36)*

DDP\_011 The transfer data request is sent by the IDE to specify to the VU the type of data that are to be downloaded. A one byte transfer request parameter (TRTP) indicates the type of transfer.

There are six types of data transfer:

- overview (TRTP 01),
- activities of a specified date (TRTP 02),
- events and faults (TRTP 03),
- detailed speed (TRTP 04),
- technical data (TRTP 05),
- card download (TRTP 06).

DDP\_054 It is mandatory for the IDE to request the overview data transfer (TRTP 01) during a download session as this only will ensure that the VU certificates are recorded within the downloaded file (and allow for verification of digital signature).

In the second case (TRTP 02) the transfer data request message includes the indication of the calendar day `TimeReal` format) to be downloaded.

#### 2.2.2.10. Positive response transfer data (SID 76)

DDP\_012 The positive response transfer data is sent by the VU in response to the transfer data request. The message contains the requested data, with a transfer response parameter (TREP) corresponding to the TRTP of the request.

DDP\_055 In the first case (TREP 01), the VU will send data helping the IDE operator to choose the data he wants to download further. The information contained within this message is:

- security certificates,
- vehicle identification,
- VU current date and time,
- minimum and maximum downloadable date (VU data),
- indication of cards presence in the VU,
- previous download to a company,
- company locks,
- previous controls.

#### 2.2.2.11. Request transfer exit (SID 37)

DDP\_013 The request transfer exit message is sent by the IDE to inform the VU that the download session is terminated.

#### 2.2.2.12. Positive response request transfer exit (SID 77)

DDP\_014 The positive response request transfer exit message is sent by the VU to acknowledge the Request Transfer Exit.

#### 2.2.2.13. Stop communication request (SID 82)

DDP\_015 The stop communication request message is sent by the IDE to disconnect the communication link with the VU.

#### 2.2.2.14. Positive response stop communication (SID C2)

DDP\_016 The positive response stop communication message is sent by the VU to acknowledge the stop communication request.

#### 2.2.2.15. Acknowledge submessage (SID 83)

DDP\_017 The acknowledge sub message is sent by the IDE to confirm receipt of each part of a message that is being transmitted as several submessages. The data field contains the SID received from the VU and a 2-byte code as follows:

- `MsgC +1` Acknowledges correct receipt of submessage number `MsgC`.  
Request from the IDE to the VU to send next submessage,
- `MsgC` indicates a problem with the receipt of submessage number `MsgC`.  
Request from the IDE to the VU to send the submessage again,
- `FFFF` requests termination of the message.

This can be used by the IDE to end the transmission of the VU message for any reason.

The last submessage of a message (`LEN` byte < 255) may be acknowledged using any of these codes or not acknowledged.

The VU responses that will consist of several sub messages are:

- positive response transfer Data (SID 76)

#### 2.2.2.16. Negative Response (SID 7F)

DDP\_018 The negative response message is sent by the VU in response to the above request messages when the VU cannot satisfy the request. The data fields of the message contains the SID of the response (7F), the SID of the request, and a code specifying the reason of the negative response. The following codes are available:

- 10 general reject  
The action cannot be performed for a reason not covered below
- 11 service not supported  
The SID of the request is not understood
- 12 sub function not supported  
The DS\_ or TRTP of the request is not understood, or there are no further sub messages to be transmitted
- 13 incorrect message length  
The length of the received message is wrong
- 22 conditions not correct or request sequence error  
The required service is not active or the sequence of request messages is not correct
- 31 request out of range  
The request parameter record (data field) is not valid
- 50 upload not accepted  
The request cannot be performed (VU in a non appropriate mode of operation or internal fault of the VU)
- 78 response pending  
The action requested cannot be completed in time and the VU is not ready to accept another request
- FA data not available  
The data object of a data transfer request are not available in the VU (e.g. no card is inserted, ...)

### 2.2.3. *Message flow*

A typical message flow during a normal data download procedure is the following:

| IDE                               |     | FE                                         |
|-----------------------------------|-----|--------------------------------------------|
| Start communication request       | ⇒   |                                            |
|                                   | ⇐   | Positive response                          |
| Start diagnostic service request  | ⇒   |                                            |
|                                   | ⇐   | Positive response                          |
| Request upload                    | ⇒   |                                            |
|                                   | ⇐   | Positive response                          |
| Transfer data request overview    | ⇒   |                                            |
|                                   | ⇐   | Positive response transfer                 |
| Data request #2                   | ⇒   |                                            |
|                                   | ⇐   | Positive response #1                       |
| Acknowledge submessage #1         | ⇒   |                                            |
|                                   | ⇐   | Positive response #2                       |
| Acknowledge submessage #2         | ⇒   |                                            |
|                                   | ⇐   | Positive response #m                       |
| Acknowledge submessage #m         | ⇒   |                                            |
|                                   | ⇐   | Positive response (Data field < 255 Bytes) |
| Acknowledge submessage (optional) | ⇒   |                                            |
|                                   | ... |                                            |
| Transfer data request #n          | ⇒   |                                            |
|                                   | ⇐   | Positive response                          |
| Request transfer exit             | ⇒   |                                            |
|                                   | ⇐   | Positive response                          |
| Stop communication request        | ⇒   |                                            |
|                                   | ⇐   | Positive response                          |

### 2.2.4. Timing

DDP\_019 During normal operation the timing parameters shown in the following figure are relevant:

Figure 1

#### Message flow, timing

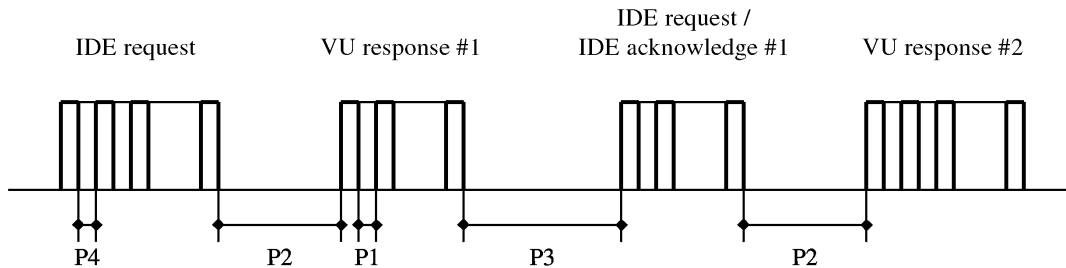

Where:

P1 = Inter byte time for VU response.

P2 = Time between end of IDE request and start of VU response, or between end of IDE acknowledge and start of next VU response.

P3 = Time between end of VU response and start of new IDE request, or between end of VU response and start of IDE acknowledge, or between end of IDE request and start of new IDE request if VU fails to respond.

P4 = Inter byte time for IDE request.

P5 = Extended value of P3 for card downloading.

The allowed values for the timing parameters are showed in the following table (KWP extended timing parameters set, used in case of physical addressing for faster communication).

| Timing Parameter | Lower limit Value (ms) | Upper limit value (ms) |
|------------------|------------------------|------------------------|
| P1               | 0                      | 20                     |
| P2               | 20                     | 1 000 (*)              |
| P3               | 10                     | 5 000                  |
| P4               | 5                      | 20                     |
| P5               | 10                     | 20 minutes             |

(\*) If the VU responds with a negative response containing a code meaning "request correctly received, response pending", this value is extended to the same upper limit value of P3.

### 2.2.5. Error handling

If an error occurs during the message exchange, the message flow scheme is modified depending on which equipment has detected the error and on the message generating the error.

In Figure 2 and Figure 3 the error handling procedures for the VU and the IDE are respectively shown.

#### 2.2.5.1. Start communication phase

DDP\_020 If the IDE detects an error during the Start Communication phase, either by timing or by the bit stream, then it will wait for a period P3 min before issuing again the request.

DDP\_021 If the VU detects an error in the sequence coming from the IDE, it shall send no response and wait for another Start Communication Request message within a period P3 max.

#### 2.2.5.2. Communication phase

Two different error handling areas can be defined:

##### 1. The VU detects an IDE transmission error.

DDP\_022 For every received message the VU shall detect timing errors, byte format errors (e.g. start and stop bit violations) and frame errors (wrong number of bytes received, wrong checksum byte).

DDP\_023 If the VU detects one of the above errors, then it sends no response and ignores the message received.

DDP\_024 The VU may detect other errors in the format or content of the received message (e.g. message not supported) even if the message satisfies the length and checksum requirements; in such a case, the VU shall respond to the IDE with a Negative Response message specifying the nature of the error.

Figure 2

VU error handling

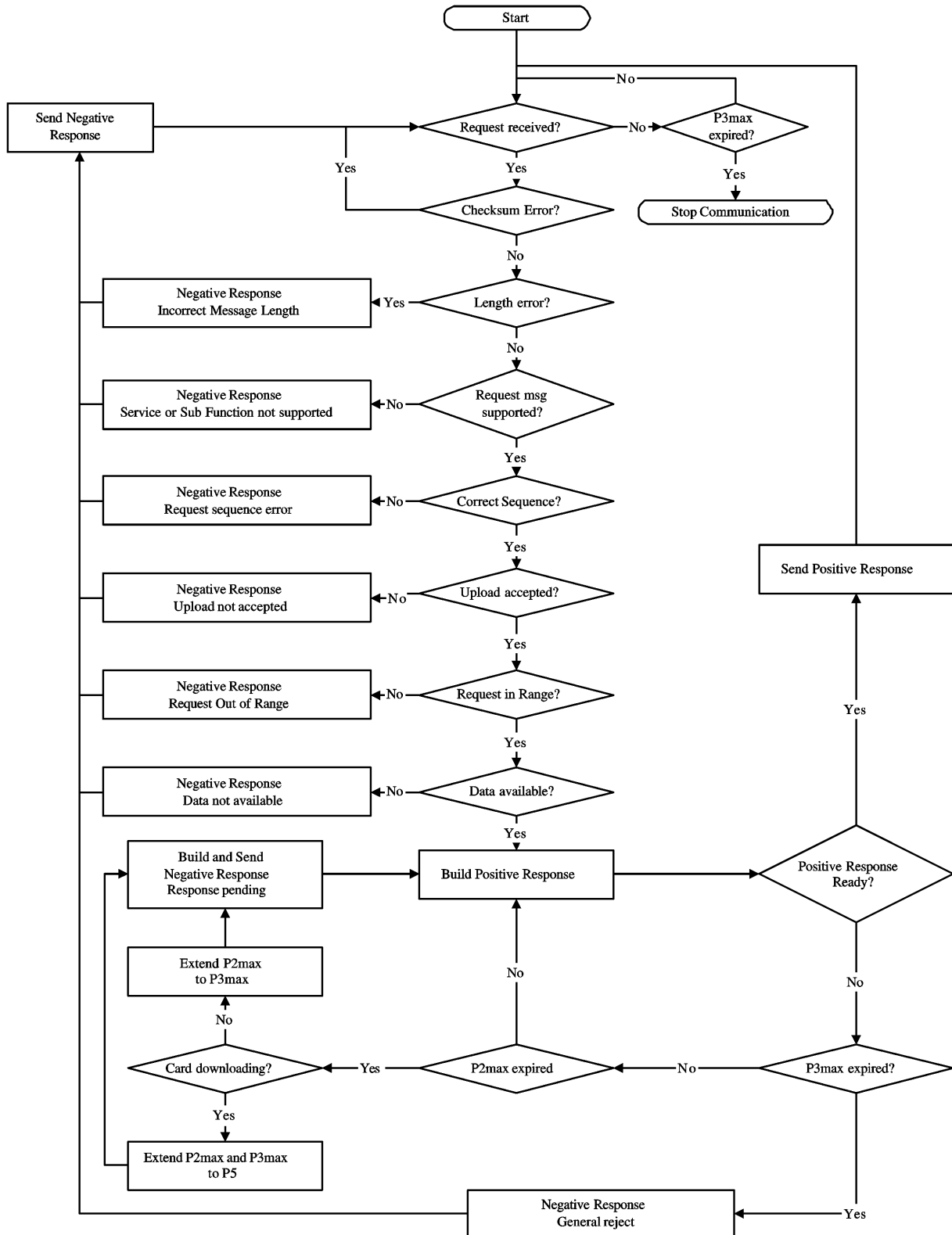

## 2. The IDE detects a VU transmission error.

- DDP\_025 For every received message the IDE shall detect timing errors, byte format errors (e.g. start and stop bit violations) and frame errors (wrong number of bytes received, wrong checksum byte).
- DDP\_026 The IDE shall detect sequence errors, e.g. incorrect sub message counter increments in successive received messages.
- DDP\_027 If the IDE detects an error or there was no response from the VU within a P2max period, the request message will be sent again for a maximum of three transmissions in total. For the purposes of this error detection a submessage acknowledge will be considered as a request to the VU.
- DDP\_028 The IDE shall wait at least for a period of P3min before beginning each transmission; the wait period shall be measured from the last calculated occurrence of a stop bit after the error was detected.

Figure 3

### IDE error handling

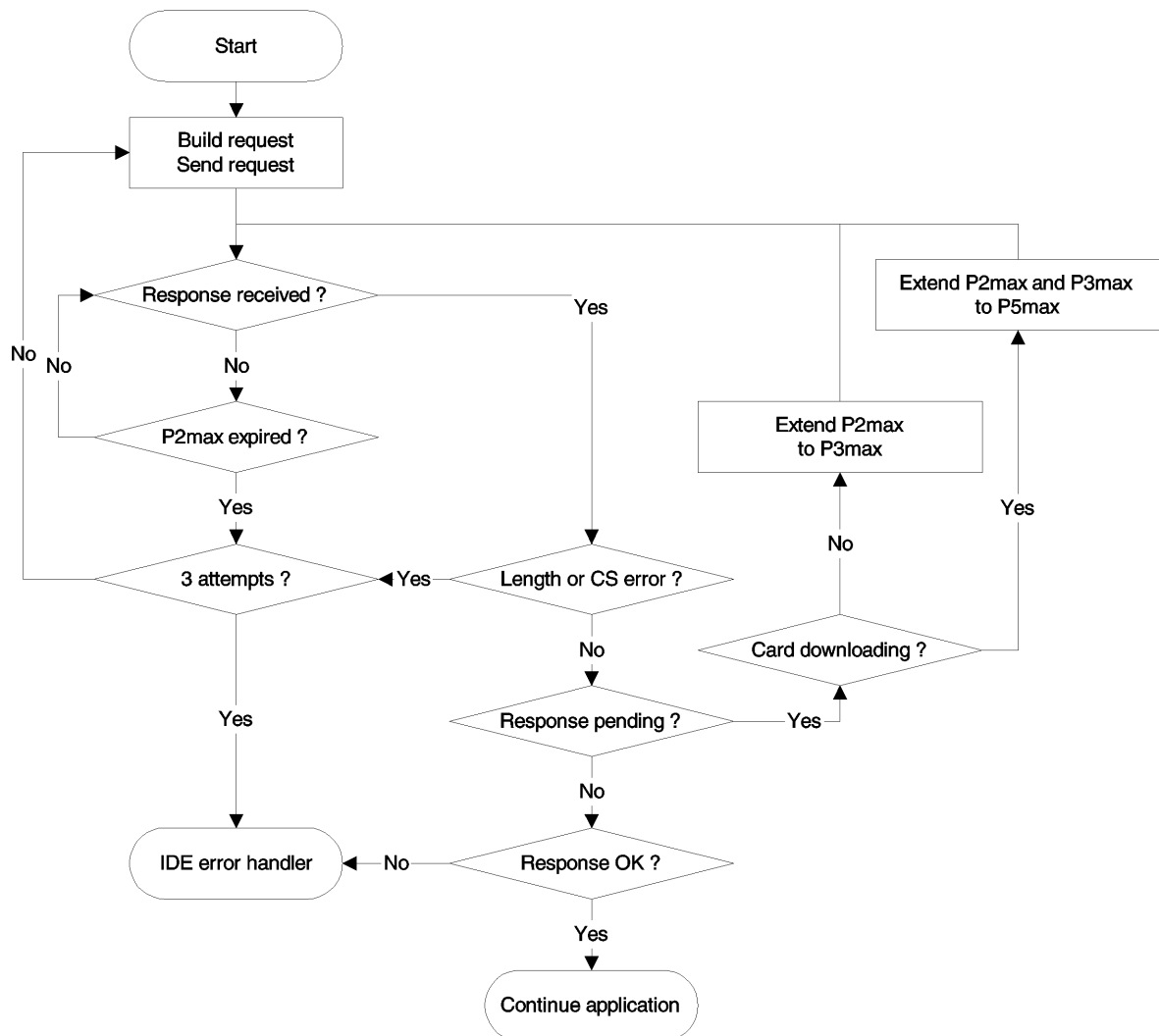

### 2.2.6. Response message content

This paragraph specifies the content of the data fields of the various positive response messages.

Data elements are defined in Appendix 1 data dictionary.

#### 2.2.6.1. Positive response transfer data overview

DDP\_029 The data field of the "positive response transfer data overview" message shall provide the following data in the following order under the SID 76 Hex, the TREP 01 Hex and appropriate sub message splitting and counting:

| Data element                                                                                                                                                                                    | Length (Bytes)                        | Comment                                                                                                                                      |
|-------------------------------------------------------------------------------------------------------------------------------------------------------------------------------------------------|---------------------------------------|----------------------------------------------------------------------------------------------------------------------------------------------|
| MemberStateCertificate<br>VUCertificate                                                                                                                                                         | 194<br>194                            | VU Security certificates                                                                                                                     |
| VehicleIdentificationNumber<br>VehicleRegistrationIdentification<br>vehicleRegistrationNation<br>vehicleRegistrationNumber                                                                      | 17<br>1<br>14                         | Vehicle identification                                                                                                                       |
| CurrentDateTime                                                                                                                                                                                 | 4                                     | VU current date and time                                                                                                                     |
| VuDownloadablePeriod<br>minDownloadableTime<br>maxDownloadableTime                                                                                                                              | 4<br>4                                | Downloadable period                                                                                                                          |
| CardSlotsStatus                                                                                                                                                                                 | 1                                     | Type of cards inserted in the VU                                                                                                             |
| VuDownloadActivityData<br>downloadingTime<br>fullCardNumber<br>companyOrWorkshopName                                                                                                            | 4<br>18<br>36                         | Previous VU download                                                                                                                         |
| VuCompanyLocksData<br>noOfLocks<br>...<br>Vu Company Locks Record<br>lockInTime<br>lockOutTime<br>companyName<br>companyAddress<br>companyCardNumber<br>...<br>...                              | 1<br>(98)<br>4<br>4<br>36<br>36<br>18 | All company locks stored. If the section is empty, only noOfLocks = 0 is sent.                                                               |
| VuControlActivityData<br>noOfControls<br>...<br>Vu Control Activity Record<br>controlType<br>controlTime<br>controlCardNumber<br>downloadPeriodBeginTime<br>downloadPeriodEndTime<br>...<br>... | 1<br>(31)<br>1<br>4<br>18<br>4<br>4   | All control records stored in the VU. If the section is empty, only noOfControls = 0 is sent.                                                |
| Signature                                                                                                                                                                                       | 128                                   | RSA signature of all data (except certificates) starting from VehicleIdentificationNumber down to last byte of last VuControlActivityRecord. |



## 2.2.6.2. Positive response transfer data activities

DDP\_030 The data field of the "positive response transfer data activities" message shall provide the following data in the following order under the SID 76 Hex, the TREP 02 Hex and appropriate sub message splitting and counting:

| Data element                                            | Length (Bytes) | Comment                                                                                                                                                                              |
|---------------------------------------------------------|----------------|--------------------------------------------------------------------------------------------------------------------------------------------------------------------------------------|
| TimeReal                                                | 4              | Date of day downloaded                                                                                                                                                               |
| OdometerValueMidnight                                   | 3              | Odometer at end of downloaded day                                                                                                                                                    |
| VuCardIWData<br>noOfVuCardIWRecords                     | 2              | Cards insertion withdrawal cycles data.                                                                                                                                              |
| ...                                                     | (129)          | — If this section contains no available data, only noOfVuCardIWRecords = 0 is sent.                                                                                                  |
| VuCardIWRecord                                          |                | — When a VuCardIWRecord lies across 00:00 (card insertion on previous day) or across 24:00 (card withdrawal the following day) it shall appear in full within the two days involved. |
| cardHolderName                                          | 36             |                                                                                                                                                                                      |
| holderSurname                                           | 36             |                                                                                                                                                                                      |
| holderFirstNames                                        | 36             |                                                                                                                                                                                      |
| fullCardNumber                                          | 18             |                                                                                                                                                                                      |
| cardExpiryDate                                          | 4              |                                                                                                                                                                                      |
| cardInsertionTime                                       | 4              |                                                                                                                                                                                      |
| vehicleOdometerValueAtInsertion                         | 3              |                                                                                                                                                                                      |
| cardSlotNumber                                          | 1              |                                                                                                                                                                                      |
| cardWithdrawalTime                                      | 4              |                                                                                                                                                                                      |
| vehicleOdometerValueAtWithdrawal                        | 3              |                                                                                                                                                                                      |
| previousVehicleInfo                                     |                |                                                                                                                                                                                      |
| vehicleRegistrationIdentification                       | 1              |                                                                                                                                                                                      |
| vehicleRegistrationNation                               | 14             |                                                                                                                                                                                      |
| vehicleRegistrationNumber                               | 4              |                                                                                                                                                                                      |
| cardWithdrawalTime                                      | 4              |                                                                                                                                                                                      |
| manualInputFlag                                         | 1              |                                                                                                                                                                                      |
| ...                                                     |                |                                                                                                                                                                                      |
| VuActivityDailyData<br>noOfActivityChanges              | 2              | Slots status at 00:00 and activity changes recorded for the day downloaded.                                                                                                          |
| ...                                                     |                |                                                                                                                                                                                      |
| ActivityChangeInfo                                      | 2              |                                                                                                                                                                                      |
| ...                                                     |                |                                                                                                                                                                                      |
| VuPlaceDailyWorkPeriodData<br>noOfPlaceRecords          | 1              | Places related data recorded for the day downloaded. If the section is empty, only noOfPlaceRecords = 0 is sent.                                                                     |
| ...                                                     | (28)           |                                                                                                                                                                                      |
| VuPlaceDailyWorkPeriodRecord                            | 18             |                                                                                                                                                                                      |
| fullCardNumber                                          | 18             |                                                                                                                                                                                      |
| placeRecord                                             | 4              |                                                                                                                                                                                      |
| entryTime                                               | 1              |                                                                                                                                                                                      |
| entryTypeDailyWorkPeriod                                | 1              |                                                                                                                                                                                      |
| dailyWorkPeriodCountry                                  | 1              |                                                                                                                                                                                      |
| dailyWorkPeriodRegion                                   | 1              |                                                                                                                                                                                      |
| vehicleOdometerValue                                    | 3              |                                                                                                                                                                                      |
| ...                                                     |                |                                                                                                                                                                                      |
| VuSpecificConditionData<br>noOfSpecificConditionRecords | 2              | Specific conditions data recorded for the day downloaded. If the section is empty, only noOfSpecificConditionRecords = 0 is sent                                                     |
| ...                                                     | (5)            |                                                                                                                                                                                      |
| SpecificConditionRecord                                 | 4              |                                                                                                                                                                                      |
| EntryTime                                               | 4              |                                                                                                                                                                                      |
| specificConditionType                                   | 1              |                                                                                                                                                                                      |
| ...                                                     |                |                                                                                                                                                                                      |
| Signature                                               | 128            | RSA signature of all data starting from TimeReal down to last byte of last specific condition record.                                                                                |

## 2.2.6.3. Positive response transfer data events and faults

DDP\_031 The data field of the "positive response transfer data events and faults" message shall provide the following data in the following order under the SID 76 Hex, the TREP 03 Hex and appropriate sub message splitting and counting:

| Data element              |                             | Length<br>(Bytes) | Comment                                                                                                                                                |                                                                                                        |
|---------------------------|-----------------------------|-------------------|--------------------------------------------------------------------------------------------------------------------------------------------------------|--------------------------------------------------------------------------------------------------------|
| VuFaultData               |                             |                   |                                                                                                                                                        |                                                                                                        |
| NoOfVuFaults              |                             | 1                 | All faults stored or on-going in the VU. If the section is empty, only noOfVuFaults = 0 is sent.                                                       |                                                                                                        |
| ...                       |                             | (82)              |                                                                                                                                                        |                                                                                                        |
| VuFaultRecord             | FaultType                   | 1                 |                                                                                                                                                        |                                                                                                        |
|                           | FaultRecordPurpose          | 1                 |                                                                                                                                                        |                                                                                                        |
|                           | FaultBeginTime              | 4                 |                                                                                                                                                        |                                                                                                        |
|                           | FaultEndTime                | 4                 |                                                                                                                                                        |                                                                                                        |
|                           | CardNumberDriverSlotBegin   | 18                |                                                                                                                                                        |                                                                                                        |
|                           | cardNumberCodriverSlotBegin | 18                |                                                                                                                                                        |                                                                                                        |
|                           | CardNumberDriverSlotEnd     | 18                |                                                                                                                                                        |                                                                                                        |
| CardNumberCodriverSlotEnd | 18                          |                   |                                                                                                                                                        |                                                                                                        |
| ...                       |                             |                   |                                                                                                                                                        |                                                                                                        |
| VuEventData               |                             |                   |                                                                                                                                                        |                                                                                                        |
| NoOfVuEvents              |                             | 1                 | All events (except over speeding) stored or on-going in the VU. If the section is empty, only noOfVuEvents = 0 is sent.                                |                                                                                                        |
| ...                       |                             | (83)              |                                                                                                                                                        |                                                                                                        |
| VuEventRecord             | EventType                   | 1                 |                                                                                                                                                        |                                                                                                        |
|                           | EventRecordPurpose          | 1                 |                                                                                                                                                        |                                                                                                        |
|                           | EventBeginTime              | 4                 |                                                                                                                                                        |                                                                                                        |
|                           | EventEndTime                | 4                 |                                                                                                                                                        |                                                                                                        |
|                           | CardNumberDriverSlotBegin   | 18                |                                                                                                                                                        |                                                                                                        |
|                           | cardNumberCodriverSlotBegin | 18                |                                                                                                                                                        |                                                                                                        |
|                           | CardNumberDriverSlotEnd     | 18                |                                                                                                                                                        |                                                                                                        |
|                           | CardNumberCodriverSlotEnd   | 18                |                                                                                                                                                        |                                                                                                        |
|                           | SimilarEventsNumber         | 1                 |                                                                                                                                                        |                                                                                                        |
| ...                       |                             |                   |                                                                                                                                                        |                                                                                                        |
| VuOverSpeedingControlData |                             |                   |                                                                                                                                                        |                                                                                                        |
| LastOverspeedControlTime  |                             | 4                 | Data related to last over speeding control (default value if no data).                                                                                 |                                                                                                        |
| FirstOverspeedSince       |                             | 4                 |                                                                                                                                                        |                                                                                                        |
| NumberOfOverspeedSince    |                             | 1                 |                                                                                                                                                        |                                                                                                        |
| VuOverSpeedingEventData   |                             |                   |                                                                                                                                                        |                                                                                                        |
| NoOfVuOverSpeedingEvents  |                             | 1                 | All over speeding events stored in the VU. If the section is empty, only noOfVuOverSpeedingEvents = 0 is sent.                                         |                                                                                                        |
| ...                       |                             | (31)              |                                                                                                                                                        |                                                                                                        |
| VuOverSpeedingEventRecord | EventType                   | 1                 |                                                                                                                                                        |                                                                                                        |
|                           | EventRecordPurpose          | 1                 |                                                                                                                                                        |                                                                                                        |
|                           | EventBeginTime              | 4                 |                                                                                                                                                        |                                                                                                        |
|                           | EventEndTime                | 4                 |                                                                                                                                                        |                                                                                                        |
|                           | MaxSpeedValue               | 1                 |                                                                                                                                                        |                                                                                                        |
|                           | AverageSpeedValue           | 1                 |                                                                                                                                                        |                                                                                                        |
|                           | CardNumberDriverSlotBegin   | 18                |                                                                                                                                                        |                                                                                                        |
|                           | SimilarEventsNumber         | 1                 |                                                                                                                                                        |                                                                                                        |
| ...                       |                             |                   |                                                                                                                                                        |                                                                                                        |
| VuTimeAdjustmentData      |                             |                   |                                                                                                                                                        |                                                                                                        |
| NoOfVuTimeAdjRecords      |                             | 1                 | All time adjustment events stored in the VU (outside the frame of a full calibration). If the section is empty, only noOfVuTimeAdjRecords = 0 is sent. |                                                                                                        |
| ...                       |                             | (98)              |                                                                                                                                                        |                                                                                                        |
| VuTimeAdjustmentRecord    | OldTimeValue                | 4                 |                                                                                                                                                        |                                                                                                        |
|                           | NewTimeValue                | 4                 |                                                                                                                                                        |                                                                                                        |
|                           | WorkshopName                | 36                |                                                                                                                                                        |                                                                                                        |
|                           | WorkshopAddress             | 36                |                                                                                                                                                        |                                                                                                        |
|                           | WorkshopCardNumber          | 18                |                                                                                                                                                        |                                                                                                        |
| ...                       |                             |                   |                                                                                                                                                        |                                                                                                        |
| Signature                 |                             | 128               |                                                                                                                                                        | RSA signature of all data starting from noOfVuFaults down to last byte of last time adjustment record. |

## 2.2.6.4. Positive response transfer data detailed speed

DDP\_032 The data field of the "positive response transfer data detailed speed" message shall provide the following data in the following order under the SID 76 Hex, the TREP 04 Hex and appropriate sub message splitting and counterling:

| Data element                           | Length (Bytes) | Comment                                                                                                                                                |
|----------------------------------------|----------------|--------------------------------------------------------------------------------------------------------------------------------------------------------|
| VuDetailedSpeedData                    |                |                                                                                                                                                        |
| NoOfSpeedBlocks                        | 2              | All time adjustment events stored in the VU (outside the frame of a full calibration). If the section is empty, only noOfVuTimeAdjRecords = 0 is sent. |
| ...                                    |                |                                                                                                                                                        |
| VuDetailedSpeedBlock                   | 4              |                                                                                                                                                        |
| SpeedBlockBeginDate<br>speedsPerSecond | 60             |                                                                                                                                                        |
| ...                                    |                |                                                                                                                                                        |
| Signature                              | 128            | RSA signature of all data starting from noOfVuFaults down to last byte of last time adjustment record.                                                 |

## 2.2.6.5. Positive response transfer data technical data

DDP\_033 The data field of the "positive response transfer data technical data" message shall provide the following data in the following order under the SID 76 Hex, the TREP 05 Hex and appropriate sub message splitting and counting:

| Data element                      | Length (Bytes) | Comment                                                                                                   |
|-----------------------------------|----------------|-----------------------------------------------------------------------------------------------------------|
| VuIdentification                  |                |                                                                                                           |
| vuManufacturerName                | 36             |                                                                                                           |
| vuManufacturerAddress             | 36             |                                                                                                           |
| vuPartNumber                      | 16             |                                                                                                           |
| vuSerialNumber                    | 8              |                                                                                                           |
| vuSoftwareIdentification          |                |                                                                                                           |
| vuSoftwareVersion                 | 4              |                                                                                                           |
| vuSoftInstallationDate            | 4              |                                                                                                           |
| vuManufacturingDate               | 4              |                                                                                                           |
| vuApprovalNumber                  | 8              |                                                                                                           |
| SensorPaired                      |                |                                                                                                           |
| sensorSerialNumber                | 8              |                                                                                                           |
| sensorApprovalNumber              | 8              |                                                                                                           |
| sensorPairingDateFirst            | 4              |                                                                                                           |
| VuCalibrationData                 |                | All calibration records stored in the VU.                                                                 |
| noOfVuCalibrationRecords          | 1              |                                                                                                           |
| ...                               | (164)          |                                                                                                           |
| VuCalibrationRecord               |                |                                                                                                           |
| calibrationPurpose                | 1              |                                                                                                           |
| workshopName                      | 36             |                                                                                                           |
| workshopAddress                   | 36             |                                                                                                           |
| workshopCardNumber                | 18             |                                                                                                           |
| workshopCardExpiryDate            | 4              |                                                                                                           |
| vehicleIdentificationNumber       | 17             |                                                                                                           |
| vehicleRegistrationIdentification |                |                                                                                                           |
| vehicleRegistrationNation         | 1              |                                                                                                           |
| vehicleRegistrationNumber         | 14             |                                                                                                           |
| wVehicleCharacteristicConstant    | 2              |                                                                                                           |
| kConstantOfRecordingEquipment     | 2              |                                                                                                           |
| lTyreCircumference                | 2              |                                                                                                           |
| tyreSize                          | 15             |                                                                                                           |
| authorisedSpeed                   | 1              |                                                                                                           |
| oldOdometerValue                  | 3              |                                                                                                           |
| newOdometerValue                  | 3              |                                                                                                           |
| oldTimeValue                      | 4              |                                                                                                           |
| newTimeValue                      | 4              |                                                                                                           |
| nextCalibrationDate               | 4              |                                                                                                           |
| ...                               |                |                                                                                                           |
| Signature                         | 128            | RSA signature of all data starting from vuManufacturerName down to last byte of last VuCalibrationRecord. |

### 2.3. ESM File storage

DDP\_034 When a download session has included a VU data transfer, the IDE shall store within one physical file all data received from the VU during the download session within positive response transfer data messages. Data stored excludes message headers, sub-message counters, empty sub-messages and checksums but include the SID and TREP (of the first sub-message only if several sub-messages).

## 3. TACHOGRAPH CARDS DOWNLOADING PROTOCOL

### 3.1. Scope

This paragraph describes the direct card data downloading of a tachograph card to an IDE. The IDE is not part of the secure environment; therefore no authentication between the card and the IDE is performed.

### 3.2. Definitions

**Download session:** Each time a download of the ICC data is performed. The session covers the complete procedure from the reset of the ICC by an IFD until the deactivation of the ICC (withdraw of the card or next reset).

**Signed data file:** A file from the ICC. The file is transferred to the IFD in plain text. On the ICC the file is hashed and signed and the signature is transferred to the IFD.

### 3.3. Card downloading

DDP\_035 The download of a tachograph card includes the following steps:

- download the common information of the card in the EFs ICC and IC. This information is optional and is not secured with a digital signature,
- Download the EFs Card\_Certificate and CA\_Certificate. This information is not secured with a digital signature,

It is mandatory to download these files for each download session.

- download the other application data EFs (within Tachograph DF) except EF Card\_Download. This information is secured with a digital signature,
  - it is mandatory to download at least the EFs Application\_Identification and ID for each download session,
  - when downloading a driver card it is also mandatory to download the following EFs:
    - Events\_Data,
    - Faults\_Data,
    - Driver\_Activity\_Data,
    - Vehicles\_Used,
    - Places,
    - Control\_Activity\_Data,
    - Specific\_Conditions.
- When downloading a driver card, update the LastCardDownload date in EF Card\_Download,
- When downloading a workshop card, reset the calibration counter in EF Card\_Download.

### 3.3.1. Initialisation sequence

DDP\_036 The IDE shall initiate the sequence as follows:

| Card | Direction | IDE/IFD        | Meaning/Remarks |
|------|-----------|----------------|-----------------|
|      | ⇐         | Hardware reset |                 |
| ATR  | ⇒         |                |                 |

It is optional to use PPS to switch to a higher baudrate as long as the ICC supports it.

### 3.3.2. Sequence for unsigned data files

DDP\_037 The sequence to download the ICC, IC, Card\_Certificate and CA\_Certificate is as follows:

| Card            | Direction | IDE/IFD           | Meaning/Remarks                                                                                                                               |
|-----------------|-----------|-------------------|-----------------------------------------------------------------------------------------------------------------------------------------------|
|                 | ⇐         | Select file       | Select file select by file identifiers                                                                                                        |
| OK              | ⇒         |                   |                                                                                                                                               |
|                 | ⇐         | Read Binary       | If the file contains more data than the buffer size of the reader or the card the command has to be repeated until the complete file is read. |
| File data<br>OK | ⇒         | Store data to ESM | according to 3.4, (Data storage format)                                                                                                       |

Note: Before selecting the Card\_Certificate EF, the Tachograph Application must be selected (selection by AID).

### 3.3.3. Sequence for signed data files

DDP\_038 The following sequence shall be used for each of the following files that has to be downloaded with their signature:

| Card                                                                                                    | Direction | IDE/IFD                                               | Meaning/Remarks                                                                                                                                                              |
|---------------------------------------------------------------------------------------------------------|-----------|-------------------------------------------------------|------------------------------------------------------------------------------------------------------------------------------------------------------------------------------|
|                                                                                                         | ⇐         | Select File                                           |                                                                                                                                                                              |
| OK                                                                                                      | ⇒         |                                                       |                                                                                                                                                                              |
|                                                                                                         | ⇐         | Perform hash of File                                  | Calculates the hash value over the data content of the selected file using the prescribed hash algorithm in accordance with Appendix 11. This command is not an ISO-Command. |
| Calculate hash of file and<br>store hash value temporarily                                              |           |                                                       |                                                                                                                                                                              |
| OK                                                                                                      | ⇒         |                                                       |                                                                                                                                                                              |
|                                                                                                         | ⇐         | Read Binary                                           | If the file contains more data than the buffer of the reader or the card can hold, the command has to be repeated until the complete file is read.                           |
| File Data<br>OK                                                                                         | ⇒         | Store received data to ESM                            | according to 3.4, (Data storage format)                                                                                                                                      |
|                                                                                                         | ⇐         | PSO: Compute digital<br>signature                     |                                                                                                                                                                              |
| Perform security operation<br>"compute digital signature"<br>using the temporarily stored<br>hash value |           |                                                       |                                                                                                                                                                              |
| Signature<br>OK                                                                                         | ⇒         | Append data to the previous<br>stored data on the ESM | according to 3.4, (Data storage format)                                                                                                                                      |

### 3.3.4. Sequence for resetting the calibration counter

DDP\_039 The sequence to reset the NoOfCalibrationsSinceDownload counter in the EF Card\_Download in a workshop card is the following:

| Card                        | Direction | IDE/IFD                                                       | Meaning/Remarks            |
|-----------------------------|-----------|---------------------------------------------------------------|----------------------------|
| OK                          | ←         | Select File EF<br>Card_Download                               | Select by file identifiers |
|                             | ⇒         |                                                               |                            |
| Resets card download number | ←         | Update Binary<br>NoOfCalibrations-<br>SinceDownload = '00 00' |                            |
|                             | ⇒         |                                                               |                            |

## 3.4. Data storage format

### 3.4.1. Introduction

DDP\_040 The downloaded data has to be stored according to the following conditions:

- the data shall be stored transparent. This means that the order of the bytes as well as the order of the bits inside the byte that are transferred from the card has to be preserved during storage,
- all files of the card downloaded within a download session are stored in one file on the ESM.

### 3.4.2. File format

DDP\_041 The file format is a concatenation of several TLV objects.

DDP\_042 The tag for an EF shall be the FID plus the appendix "00".

DDP\_043 The tag of an EF's signature shall be the FID of the file plus the appendix "01".

DDP\_044 The length is a two byte value. The value defines the number of bytes in the value field. The value "FF FF" in the length field is reserved for future use.

DDP\_045 When a file is not downloaded nothing related to the file shall be stored (no tag and no zero length).

DDP\_046 A signature shall be stored as the next TLV object directly after the TLV object that contains the data of the file.

| Definition            | Meaning                      | Length  |
|-----------------------|------------------------------|---------|
| FID (2 Bytes)    "00" | Tag for EF (FID)             | 3 Bytes |
| FID (2 Bytes)    "01" | Tag for Signature of EF(FID) | 3 Bytes |
| xx xx                 | Length of value field        | 2 Bytes |

Example of data in a download file on an ESM:

| Tag      | Length | Value                         |
|----------|--------|-------------------------------|
| 00 02 00 | 00 11  | Data of EF ICC                |
| C1 00 00 | 00 C2  | Data of EF Card_Certificate   |
|          |        | ...                           |
| 05 05 00 | 0A 2E  | Data of EF Vehicles_Used      |
| 05 05 01 | 00 80  | Signature of EF Vehicles_Used |

#### 4. DOWNLOADING A TACHOGRAPH CARD VIA A VEHICLE UNIT

- DDP\_047 The VU must allow for downloading the content of a driver card inserted to a connected IDE.
- DDP\_048 The IDE shall send a "transfer data request card download" message to the VU to initiate this mode (see 2.2.2.9).
- DDP\_049 The VU shall then download the whole card, file by file, in accordance with the card downloading protocol defined in paragraph 3, and forward all data received from the card to the IDE within the appropriate TLV file format (see 3.4.2) and encapsulated within a "positive response transfer data" message.
- DDP\_050 The IDE shall retrieve card data from the "positive response transfer data" message (stripping all headers, SIDs, TREPs, submessage counters, and checksums) and store them within one physical file as described in paragraph 2.3.
- DDP\_051 The VU shall then, as applicable, update the `Control_Activity_Data` or the `Card_Download` file of the driver card.
-

## Appendix 8

**CALIBRATION PROTOCOL**

## CONTENTS

|        |                                                                     |     |
|--------|---------------------------------------------------------------------|-----|
| 1.     | Introduction .....                                                  | 170 |
| 2.     | Terms, Definitions and References .....                             | 170 |
| 3.     | Overview of services .....                                          | 170 |
| 3.1.   | Services available .....                                            | 170 |
| 3.2.   | Response codes .....                                                | 171 |
| 4.     | Communication Services .....                                        | 171 |
| 4.1.   | StartCommunication Service .....                                    | 171 |
| 4.2.   | StopCommunication Service .....                                     | 173 |
| 4.2.1. | Message description .....                                           | 173 |
| 4.2.2. | Message format .....                                                | 174 |
| 4.2.3. | Parameter Definition .....                                          | 175 |
| 4.3.   | TesterPresent Service .....                                         | 175 |
| 4.3.1. | Message description .....                                           | 175 |
| 4.3.2. | Message format .....                                                | 175 |
| 5.     | Management Services .....                                           | 176 |
| 5.1.   | StartDiagnosticSession service .....                                | 176 |
| 5.1.1. | Message description .....                                           | 176 |
| 5.1.2. | Message format .....                                                | 177 |
| 5.1.3. | Parameter definition .....                                          | 178 |
| 5.2.   | SecurityAccess service .....                                        | 178 |
| 5.2.1. | Message description .....                                           | 178 |
| 5.2.2. | Message format — SecurityAccess — requestSeed .....                 | 179 |
| 5.2.3. | Message format — SecurityAccess — sendKey .....                     | 180 |
| 6.     | Data Transmission Services .....                                    | 181 |
| 6.1.   | DataByIdentifier service .....                                      | 181 |
| 6.1.1. | Message description .....                                           | 181 |
| 6.1.2. | Message format .....                                                | 181 |
| 6.1.3. | Parameter Definition .....                                          | 182 |
| 6.2.   | WriteDataByIdentifier service .....                                 | 183 |
| 6.2.1. | Message description .....                                           | 183 |
| 6.2.2. | Message format .....                                                | 183 |
| 6.2.3. | Parameter definition .....                                          | 184 |
| 7.     | Control of Test Pulses — Input/Output Control functional unit ..... | 184 |
| 7.1.   | InputOutputControlByIdentifier service .....                        | 184 |



---

|        |                                    |     |
|--------|------------------------------------|-----|
| 7.1.1. | Message description .....          | 184 |
| 7.1.2. | Message format .....               | 185 |
| 7.1.3. | Parameter definition .....         | 186 |
| 8.     | dataRecords formats .....          | 187 |
| 8.1.   | Transmitted parameter ranges ..... | 187 |
| 8.2.   | dataRecords formats .....          | 188 |

## 1. INTRODUCTION

This appendix describes how data is exchanged between a vehicle unit and a tester via the K-line which forms part of the calibration interface described in Appendix 6. It also describes control of the input/output signal line on the calibration connector.

Establishing K-line communications is described in Section 4 "Communication Services".

This appendix uses the idea of diagnostic "sessions" to determine the scope of K-line control under different conditions. The default session is the "StandardDiagnosticSession" where all data can be read from a vehicle unit but no data can be written to a vehicle unit.

Selection of the diagnostic session is described in Section 5 "Management Services".

CPR\_001 The "ECUProgrammingSession" allows data entry into the vehicle unit. In the case of entry of calibration data (requirements 097 and 098), the vehicle unit must, in addition be in the CALIBRATION mode of operation.

Data transfer via K-line is described in Section 6 "Data Transmission Services". Formats of data transferred are detailed in Section 8 "dataRecords formats".

CPR\_002 The "ECUAdjustmentSession" allows the selection of the I/O mode of the calibration I/O signal line via the K-line interface. Control of the calibration I/O signal line is described in section 7 "Control of Test Pulses — Input/Output Control functional unit".

CPR\_003 Throughout this document the address of the tester is referred to as 'tt'. Although there may be preferred addresses for testers, the VU shall respond correctly to any tester address. The physical address of the VU is 0xEE.

## 2. TERMS, DEFINITIONS AND REFERENCES

The protocols, messages and error codes are principally based on the current draft to date of ISO 14229-1 (Road vehicles — Diagnostic systems — Part 1: Diagnostic services, version 6 of 22 February 2001).

Byte encoding and hexadecimal values are used for the service identifiers, the service requests and responses, and the standard parameters.

The term "tester" refers to the equipment used to enter programming/calibration data into the VU.

The terms "client" and "server" refer to the tester and the VU respectively.

The term ECU means "Electronic Control Unit" and refers to the VU.

### References:

ISO 14230-2: Road Vehicles — Diagnostic Systems — Keyword Protocol 2000- Part 2: Data Link Layer. First edition: 1999. Vehicles — Diagnostic Systems.

## 3. OVERVIEW OF SERVICES

### 3.1. Services available

The following table provides an overview of the services that will be available in the recording equipment and are defined in this document.

CPR\_004 The table indicates the services that are available in an enabled diagnostic session.

— The first column lists the services that are available,

— the second column includes the section number in this appendix where of service is further defined,

- the third column assigns the service identifier values for request messages,
- the fourth column specifies the services of the "StandardDiagnosticSession" (SD) which must be implemented in each VU,
- the fifth column specifies the services of the "ECUAdjustmentSession" (ECUAS) which must be implemented to allow control of the I/O signal line in the front panel calibration connector of the VU,
- the sixth column specifies the services of the "ECUProgrammingSession" (ECUPS) which must be implemented to allow for programming of parameters in the VU.

Table 1

**Service Identifier value summary table**

| Diagnostic Service Name        | Section No | Sid Req.Value | Diagnostic Sessions |       |       |
|--------------------------------|------------|---------------|---------------------|-------|-------|
|                                |            |               | SD                  | ECUAS | ECUPS |
| StartCommunication             | 4.1        | 81            | ■                   | ■     | ■     |
| StopCommunication              | 4.2        | 82            | ■                   |       |       |
| TesterPresent                  | 4.3        | 3E            | ■                   | ■     | ■     |
| StartDiagnosticSession         | 5.1        | 10            | ■                   | ■     | ■     |
| SecurityAccess                 | 5.2        | 27            | ■                   | ■     | ■     |
| ReadDataByIdentifier           | 6.1        | 22            | ■                   | ■     | ■     |
| WriteDataByIdentifier          | 6.2        | 2E            |                     |       | ■     |
| InputOutputControlByIdentifier | 7.1        | 2F            |                     | ■     |       |

■ This symbol indicates that the service is mandatory in this diagnostic session.  
 No symbol indicates that this service is not allowed in this diagnostic session.

### 3.2. Response codes

Response codes are defined for each service.

## 4. COMMUNICATION SERVICES

Some services are necessary to establish and maintain communication. They do not appear on the application layer. The services available are detailed in the following table:

Table 2

**Communication services**

| Service name       | Description                                                           |
|--------------------|-----------------------------------------------------------------------|
| StartCommunication | The client requests to start a communication session with a server(s) |
| StopCommunication  | The client requests to stop the current communication session         |
| TesterPresent      | The client indicates to the server that it is still present           |

CPR\_005 The StartCommunication Service is used for starting a communication. In order to perform any service, communication must be initialised and the communication parameters need to be appropriate for the desired mode.

### 4.1. StartCommunication Service

CPR\_006 Upon receiving a StartCommunication indication primitive, the VU shall check if the requested communication link can be initialised under the present conditions. Valid conditions for the initialisation of a communication link are described in document ISO 14230-2.

CPR\_007 Then the VU shall perform all actions necessary to initialise the communication link and send a StartCommunication response primitive with the positive response parameters selected.

- CPR\_008 If a VU that is already initialised (and has entered any diagnostic session) receives a new StartCommunication request (e.g. due to error recovery in the tester) the request shall be accepted and the VU shall be re-initialised.
- CPR\_009 If the communication link cannot be initialised for any reason, the VU shall continue operating as it was immediately prior to the attempt to initialise the communication link.
- CPR\_010 The StartCommunication Request message must be physically addressed.
- CPR\_011 Initialising the VU for services is performed through a "fast initialisation" method,
- there is a bus-idle time prior to any activity,
  - the tester then sends an initialisation pattern,
  - all information which is necessary to establish communication is contained in the response of the VU.
- CPR\_012 After completion of the initialisation,
- all communication parameters are set to values defined in Table 4 according to the key bytes,
  - the VU is waiting for the first request of the tester,
  - the VU is in the default diagnostic mode, i.e. StandardDiagnosticSession,
  - the calibration I/O signal line is in the default state, i.e. disabled state.
- CPR\_014 The data rate on the K-line shall be 10 400 Baud.
- CPR\_016 The fast initialisation is started by the tester transmitting a wake-up pattern (Wup) on the K-line. The pattern begins after the idle time on K-line with a low time of  $T_{inil}$ . The tester transmits the first bit of the StartCommunication Service after a time of  $T_{wup}$  following the first falling edge.

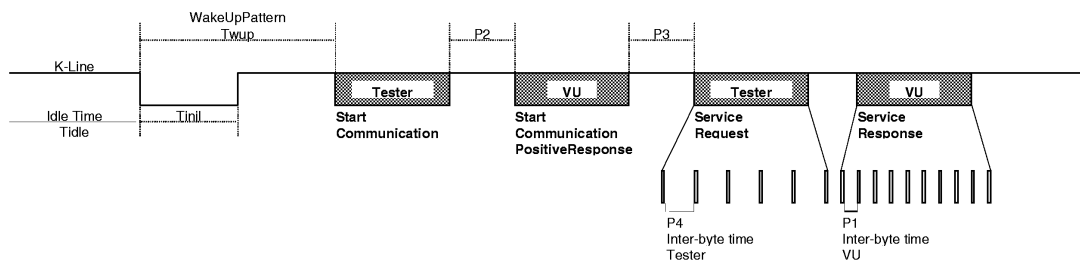

- CPR\_017 The timing values for the fast initialisation and communications in general are detailed in the tables below. There are different possibilities for the idle time:
- first transmission after power on,  $T_{idle} = 300$  ms.
  - after completion of a StopCommunication Service,  $T_{idle} = P3$  min.
  - after stopping communication by time-out  $P3$  max,  $T_{idle} = 0$ .

Table 3

## Timing values for fast initialisation

| Parameter  |               | minimum value | maximum value |
|------------|---------------|---------------|---------------|
| $T_{inil}$ | $25 \pm 1$ ms | 24 ms         | 26 ms         |
| $T_{wup}$  | $50 \pm 1$ ms | 49 ms         | 51 ms         |

Table 4

**Communication timing values**

| Timing parameter | Parameter description                                            | Lower limit values (ms) | Upper limit values (ms) |
|------------------|------------------------------------------------------------------|-------------------------|-------------------------|
|                  |                                                                  | minimum                 | maximum                 |
| P1               | Inter byte time for VU response                                  | 0                       | 20                      |
| P2               | Time between tester request and VU response or two VU responses  | 25                      | 250                     |
| P3               | Time between end of VU responses and start of new tester request | 55                      | 5 000                   |
| P4               | Inter byte time for tester request                               | 5                       | 20                      |

CPR\_018 The message format for fast initialisation is detailed in the following tables:

Table 5

**StartCommunication request message**

| Byte # | Parameter Name                     | Hex value | Mnemonic |
|--------|------------------------------------|-----------|----------|
| #1     | Format byte — physical addressing  | 81        | FMT      |
| #2     | Target address byte                | EE        | TGT      |
| #3     | Source address byte                | tt        | SRC      |
| #4     | StartCommunication Request Service | 81        | SCR      |
| #5     | Checksum                           | 00-FF     | CS       |

Table 6

**StartCommunication positive response message**

| Byte # | Parameter Name                                  | Hex value | Mnemonic |
|--------|-------------------------------------------------|-----------|----------|
| #1     | Format byte — physical addressing               | 80        | FMT      |
| #2     | Target address byte                             | tt        | TGT      |
| #3     | Source address byte                             | EE        | SRC      |
| #4     | Additional length byte                          | 03        | LEN      |
| #5     | StartCommunication Positive Response Service Id | C1        | SCRPR    |
| #6     | Key byte 1                                      | EA        | KB1      |
| #7     | Key byte 2                                      | 8F        | KB2      |
| #8     | Checksum                                        | 00-FF     | CS       |

CPR\_019 There is no negative response to the StartCommunication Request message, if there is no positive response message to be transmitted then the VU is not initialised, nothing is transmitted and it remains in its normal operation.

#### 4.2. StopCommunication service

##### 4.2.1. Message description

The purpose of this communication layer service is to terminate a communication session.

CPR\_020 Upon receiving a StopCommunication indication primitive, the VU shall check if the current conditions allow to terminate this communication. In this case the VU shall perform all actions necessary to terminate this communication.

- CPR\_021 If it is possible to terminate the communication, the VU shall issue a StopCommunication response primitive with the Positive Response parameters selected, before the communication is terminated.
- CPR\_022 If the communication cannot be terminated by any reason, the VU shall issue a StopCommunication response primitive with the Negative Response parameter selected.
- CPR\_023 If time -out of P3max is detected by the VU, the communication shall be terminated without any response primitive being issued.

#### 4.2.2. Message format

- CPR\_024 The message formats for the StopCommunication primitives are detailed in the following tables:

Table 7

##### StopCommunication request message

| Byte # | Parameter Name                       | Hex value | Mnemonic |
|--------|--------------------------------------|-----------|----------|
| #1     | Format byte — physical addressing    | 80        | FMT      |
| #2     | Target address byte                  | EE        | TGT      |
| #3     | Source address byte                  | tt        | SRC      |
| #4     | Additional length byte               | 01        | LEN      |
| #5     | StopCommunication Request Service Id | 82        | SPR      |
| #6     | Checksum                             | 00-FF     | CS       |

Table 8

##### StopCommunication positive response message

| Byte # | Parameter Name                              | Hex value | Mnemonic |
|--------|---------------------------------------------|-----------|----------|
| #1     | Format byte — physical addressing           | 80        | FMT      |
| #2     | Target address byte                         | tt        | TGT      |
| #3     | Source address byte                         | EE        | SRC      |
| #4     | Additional length byte                      | 01        | LEN      |
| #5     | StopCommunication Positive Response Service | C2        | SPRPR    |
| #6     | Checksum                                    | 00-FF     | CS       |

Table 9

##### StopCommunication negative response message

| Byte # | Parameter Name                                   | Hex value | Mnemonic |
|--------|--------------------------------------------------|-----------|----------|
| #1     | Format byte — physical addressing                | 80        | FMT      |
| #2     | Target address byte                              | tt        | TGT      |
| #3     | Source address byte                              | EE        | SRC      |
| #4     | Additional length byte                           | 03        | LEN      |
| #5     | negative Response Service Id                     | 7F        | NR       |
| #6     | StopCommunication Request Service Identification | 82        | SPR      |
| #7     | responseCode = generalReject                     | 10        | RC_GR    |
| #8     | Checksum                                         | 00-FF     | CS       |

#### 4.2.3. *Parameter definition*

This service does not require any parameter definition.

### 4.3. **TesterPresent service**

#### 4.3.1. *Message description*

The TesterPresent service is used by the tester to indicate to the server that it is still present, in order to prevent the server from automatically returning to normal operation and possibly stopping the communication. This service, sent periodically, keeps the diagnostic session/communication active by resetting the P3 timer each time a request for this service is received.

#### 4.3.2. *Message format*

CPR\_079 The message formats for the TesterPresent primitives are detailed in the following tables.

Table 10

**TesterPresent request message**

| Byte # | Parameter Name                                | Hex value | Mnemonic                |
|--------|-----------------------------------------------|-----------|-------------------------|
| #1     | Format byte — physical addressing             | 80        | FMT                     |
| #2     | Target address byte                           | EE        | TGT                     |
| #3     | Source address byte                           | tt        | SRC                     |
| #4     | Additional length byte                        | 02        | LEN                     |
| #5     | TesterPresent Request Service Id              | 3E        | TP                      |
| #6     | Sub Function = responseRequired = [yes<br>no] | 01<br>02  | RESPREQ_Y<br>RESPREQ_NO |
| #7     | Checksum                                      | 00-FF     | CS                      |

CPR\_080 If the responseRequired parameter is set to “yes”, then the server shall respond with the following positive response message. If set to “no”, then no response is sent by the server.

Table 11

**TesterPresent positive response message**

| Byte # | Parameter Name                             | Hex value | Mnemonic |
|--------|--------------------------------------------|-----------|----------|
| #1     | Format byte — physical addressing          | 80        | FMT      |
| #2     | Target address byte                        | tt        | TGT      |
| #3     | Source address byte                        | EE        | SRC      |
| #4     | Additional length byte                     | 01        | LEN      |
| #5     | TesterPresent Positive Response Service Id | 7E        | TPPR     |
| #6     | Checksum                                   | 00-FF     | CS       |

CPR\_081 The service shall support the following negative responses codes:

Table 12

**TesterPresent negative response message**

| Byte # | Parameter Name                                                                   | Hex value | Mnemonic   |
|--------|----------------------------------------------------------------------------------|-----------|------------|
| #1     | Format byte — physical addressing                                                | 80        | FMT        |
| #2     | Target address byte                                                              | tt        | TGT        |
| #3     | Source address byte                                                              | EE        | SRC        |
| #4     | Additional length byte                                                           | 03        | LEN        |
| #5     | negative Response Service Id                                                     | 7F        | NR         |
| #6     | TesterPresent Request Service Identification                                     | 3E        | TP         |
| #7     | responseCode = [SubFunctionNotSupported-InvalidFormat<br>incorrectMessageLength] | 12        | RC_SFNS_IF |
|        |                                                                                  | 13        | RC_IML     |
| #8     | Checksum                                                                         | 00-FF     | CS         |

## 5. MANAGEMENT SERVICES

The services available are detailed in the following table:

Table 13

**Management services**

| Service name           | Description                                                            |
|------------------------|------------------------------------------------------------------------|
| StartDiagnosticSession | The client requests to start a diagnostic session with a VU            |
| SecurityAccess         | The client requests access to functions restricted to authorised users |

### 5.1. StartDiagnosticSession service

#### 5.1.1. Message description

CPR\_025 The service StartDiagnosticSession is used to enable different diagnostic sessions in the server. A diagnostic session enables a specific set of services according to Table 17. A session can enable vehicle manufacturer specific services which are not part of this document. Implementation rules shall conform to the following requirements:

- there shall be always exactly one diagnostic session active in the VU,
- the VU shall always start the StandardDiagnosticSession when powered up. If no other diagnostic session is started, then the StandardDiagnosticSession shall be running as long as the VU is powered,
- if a diagnostic session which is already running has been requested by the tester, then the VU shall send a positive response message,
- whenever the tester requests a new diagnostic session, the VU shall first send a StartDiagnosticSession positive response message before the new session becomes active in the VU. If the VU is not able to start the requested new diagnostic session, then it shall respond with a StartDiagnosticSession negative response message, and the current session shall continue.

CPR\_026 The diagnostic session shall only be started if communication has been established between the client and the VU.

CPR\_027 The timing parameters defined in Table 4 shall be active after a successful StartDiagnosticSession with the diagnosticSession parameter set to "StandardDiagnosticSession" in the request message if another diagnostic session was previously active.



5.1.2. *Message format*

CPR\_028 The message formats for the StartDiagnosticSession primitives are detailed in the following tables:

Table 14

**StartDiagnosticSession request message**

| Byte # | Parameter Name                                | Hex value | Mnemonic |
|--------|-----------------------------------------------|-----------|----------|
| #1     | Format byte — physical addressing             | 80        | FMT      |
| #2     | Target address byte                           | EE        | TGT      |
| #3     | Source address byte                           | tt        | SRC      |
| #4     | Additional length byte                        | 02        | LEN      |
| #5     | StartDiagnosticSession request service Id     | 10        | STDS     |
| #6     | diagnosticSession = (one value from Table 17) | xx        | DS_...   |
| #7     | Checksum                                      | 00-FF     | CS       |

Table 15

**StartDiagnosticSession positive response message**

| Byte # | Parameter Name                                          | Hex value | Mnemonic |
|--------|---------------------------------------------------------|-----------|----------|
| #1     | Format byte — physical addressing                       | 80        | FMT      |
| #2     | Target address byte                                     | tt        | TGT      |
| #3     | Source address byte                                     | EE        | SRC      |
| #4     | Additional length byte                                  | 02        | LEN      |
| #5     | StartDiagnosticSession Positive Response Service Id     | 50        | STDSR    |
| #6     | DiagnosticSession = (same value as in byte #6 Table 14) | xx        | DS_...   |
| #7     | Checksum                                                | 00-FF     | CS       |

Table 16

**StartDiagnosticSession negative response message**

| Byte # | Parameter Name                                           | Hex value | Mnemonic |
|--------|----------------------------------------------------------|-----------|----------|
| #1     | Format byte — physical addressing                        | 80        | FMT      |
| #2     | Target address byte                                      | tt        | TGT      |
| #3     | Source address byte                                      | EE        | SRC      |
| #4     | Additional length byte                                   | 03        | LEN      |
| #5     | Negative response service Id                             | 7F        | NR       |
| #6     | StartDiagnosticSession request service Id                | 10        | STDS     |
| #7     | ResponseCode = (subFunctionNotSupported <sup>(a)</sup> ) | 12        | RC_SFNS  |
|        | incorrectMessageLength <sup>(b)</sup>                    | 13        | RC_IML   |
|        | conditionsNotCorrect <sup>(c)</sup>                      | 22        | RC_CNC   |
| #8     | Checksum                                                 | 00-FF     | CS       |

<sup>(a)</sup> The value inserted in byte #6 of the request message is not supported, i.e. not in Table 17.

<sup>(b)</sup> The length of the message is wrong.

<sup>(c)</sup> The criteria for the request StartDiagnosticSession are not met.

### 5.1.3. *Parameter definition*

CPR\_029 The parameter *diagnosticSession* (DS\_) is used by the StartDiagnosticSession service to select the specific behaviour of the server(s). The following diagnostic sessions are specified in this document:

Table 17

#### Definition of diagnosticSession values

| Hex | Description                                                                                                                                                                                                                                                                                                                                                                                                   | Mnemonic |
|-----|---------------------------------------------------------------------------------------------------------------------------------------------------------------------------------------------------------------------------------------------------------------------------------------------------------------------------------------------------------------------------------------------------------------|----------|
| 81  | StandardDiagnosticSession<br>This diagnostic session enables all services specified in Table 1 column 4 "SD". These services allow reading of data from a server (VU). This diagnostic Session is active after the initialisation has been successfully completed between client (tester) and server (VU). This diagnostic session may be overwritten by other diagnostic sessions specified in this section. | SD       |
| 85  | ECUProgrammingSession<br>This diagnostic session enables all services specified in Table 1 column 6 "ECUPS". These services support the memory programming of a server (VU) This diagnostic session may be overwritten by other diagnostic sessions specified in this section.                                                                                                                                | ECUPS    |
| 87  | ECUAdjustmentSession<br>This diagnostic session enables all services specified in Table 1 column 5 "ECUAS". These services support the input/output control of a server (VU). This diagnostic session may be overwritten by other diagnostic sessions specified in this section.                                                                                                                              | ECUAS    |

### 5.2. *SecurityAccess service*

Writing of calibration data or access to the calibration input/output line is not possible unless the VU is in CALIBRATION mode. In addition to insertion of a valid workshop card into the VU, it is necessary to enter the appropriate PIN into the VU before access to the CALIBRATION mode is granted.

The SecurityAccess service provides a means to enter the PIN and to indicate to the tester whether or not the VU is in CALIBRATION mode.

It is acceptable that the PIN may be entered through alternative methods.

#### 5.2.1. *Message description*

The SecurityAccess service consists of a SecurityAccess "requestSeed" message, eventually followed by a SecurityAccess "sendKey" message. The SecurityAccess service must be carried out after the StartDiagnosticSession service.

CPR\_033 The tester shall use the SecurityAccess "requestSeed" message to check if the vehicle unit is ready to accept a PIN.

CPR\_034 If the vehicle unit is already in CALIBRATION mode, it shall answer the request by sending a "seed" of 0x0000 using the service SecurityAccess Positive Response.

CPR\_035 If the vehicle unit is ready to accept a PIN for verification by a workshop card, it shall answer the request by sending a "seed" greater than 0x0000 using the service SecurityAccess positive response.

CPR\_036 If the vehicle unit is not ready to accept a PIN from the tester, either because the workshop card inserted is not valid, or because no workshop card has been inserted, or because the vehicle unit expects the PIN from another method, it shall answer the request with a negative response with a response code set to conditionsNotCorrectOrRequestSequenceError.

CPR\_037 The tester shall then, eventually, use the SecurityAccess "sendKey" message to forward a PIN to the Vehicle Unit. To allow time for the card authentication process to take place, the VU shall use the negative response code requestCorrectlyReceived-ResponsePending to extend the time to respond. However, the maximum time to respond shall not exceed five minutes. As soon as the requested service has been completed, the VU shall send a positive response message or negative response message with a response code different from this one. The negative response code requestCorrectlyReceived-ResponsePending may be repeated by the VU until the requested service is completed and the final response message is sent.

CPR\_038 The vehicle unit shall answer to this request using the service SecurityAccess Positive Response only when in CALIBRATION mode.

CPR\_039 In the following cases, the vehicle unit shall answer to this request with a Negative Response with a response code set to:

- subFunctionNot supported: invalid format for the subfunction parameter (accessType),
- conditionsNotCorrectOrRequestSequenceError: vehicle unit not ready to accept a PIN entry,
- invalidKey: PIN not valid and number of PIN checks attempts not exceeded,
- exceededNumberOfAttempts: PIN not valid and number of PIN checks attempts exceeded,
- generalReject: Correct PIN but mutual authentication with workshop card failed.

#### 5.2.2. Message format — SecurityAccess — requestSeed

CPR\_040 The message formats for the SecurityAccess “requestSeed” primitives are detailed in the following tables:

Table 18

**SecurityAccess request — requestSeed message**

| Byte # | Parameter Name                    | Hex value | Mnemonic |
|--------|-----------------------------------|-----------|----------|
| #1     | Format byte — physical addressing | 80        | FMT      |
| #2     | Target address byte               | EE        | TGT      |
| #3     | Source address byte               | tt        | SRC      |
| #4     | Additional length byte            | 02        | LEN      |
| #5     | SecurityAccess request service Id | 27        | SA       |
| #6     | accessType — requestSeed          | 7D        | AT_RSD   |
| #7     | Checksum                          | 00-FF     | CS       |

Table 19

**SecurityAccess — requestSeed positive response message**

| Byte # | Parameter Name                              | Hex value | Mnemonic |
|--------|---------------------------------------------|-----------|----------|
| #1     | Format byte — physical addressing           | 80        | FMT      |
| #2     | Target address byte                         | tt        | TGT      |
| #3     | Source address byte                         | EE        | SRC      |
| #4     | Additional length byte                      | 04        | LEN      |
| #5     | SecurityAccess positive response service Id | 67        | SAPR     |
| #6     | accessType — requestSeed                    | 7D        | AT_RSD   |
| #7     | Seed High                                   | 00-FF     | SEEDH    |
| #8     | Seed Low                                    | 00-FF     | SEEDL    |
| #9     | Checksum                                    | 00-FF     | CS       |

Table 20

**SecurityAccess negative response message**

| Byte # | Parameter Name                                                                        | Hex value | Mnemonic |
|--------|---------------------------------------------------------------------------------------|-----------|----------|
| #1     | Format byte — physical addressing                                                     | 80        | FMT      |
| #2     | Target address byte                                                                   | tt        | TGT      |
| #3     | Source address byte                                                                   | EE        | SRC      |
| #4     | Additional length byte                                                                | 03        | LEN      |
| #5     | negativeResponse Service Id                                                           | 7F        | NR       |
| #6     | SecurityAccess request service Id                                                     | 27        | SA       |
| #7     | responseCode = (conditionsNotCorrectOrRequestSequenceError<br>incorrectMessageLength) | 22        | RC_CNC   |
|        |                                                                                       | 13        | RC_JML   |
| #8     | Checksum                                                                              | 00-FF     | CS       |

5.2.3. **Message format — SecurityAccess — sendKey**

CPR\_041 The message formats for the SecurityAccess “sendKey” primitives are detailed in the following tables:

Table 21

**SecurityAccess request — sendKey message**

| Byte #     | Parameter Name                                             | Hex value | Mnemonic |
|------------|------------------------------------------------------------|-----------|----------|
| #1         | Format byte — physical addressing                          | 80        | FMT      |
| #2         | Target address byte                                        | EE        | TGT      |
| #3         | Source address byte                                        | tt        | SRC      |
| #4         | Additional length byte                                     | m+2       | LEN      |
| #5         | SecurityAccess Request Service Id                          | 27        | SA       |
| #6         | accessType — sendKey                                       | 7E        | AT_SK    |
| #7 to #m+6 | Key #1 (High)                                              | xx        | KEY      |
|            | ...                                                        | ...       |          |
|            | Key #m (low, m must be a minimum of 4, and a maximum of 8) | xx        |          |
| #m+7       | Checksum                                                   | 00-FF     | CS       |

Table 22

**SecurityAccess — sendKey positive response message**

| Byte # | Parameter Name                              | Hex value | Mnemonic |
|--------|---------------------------------------------|-----------|----------|
| #1     | Format byte — physical addressing           | 80        | FMT      |
| #2     | Target address byte                         | tt        | TGT      |
| #3     | Source address byte                         | EE        | SRC      |
| #4     | Additional length byte                      | 02        | LEN      |
| #5     | SecurityAccess positive response service Id | 67        | SAPR     |
| #6     | accessType — sendKey                        | 7E        | AT_SK    |
| #7     | Checksum                                    | 00-FF     | CS       |

Table 23

**SecurityAccess negative response message**

| Byte # | Parameter Name                             | Hex value | Mnemonic  |
|--------|--------------------------------------------|-----------|-----------|
| #1     | Format byte — physical addressing          | 80        | FMT       |
| #2     | Target address byte                        | tt        | TGT       |
| #3     | Source address byte                        | EE        | SRC       |
| #4     | Additional length byte                     | 03        | LEN       |
| #5     | NegativeResponse Service Id                | 7F        | NR        |
| #6     | SecurityAccess request service Id          | 27        | SA        |
| #7     | ResponseCode = (generalReject              | 10        | RC_GR     |
|        | subFunctionNotSupported                    | 12        | RC_SFNS   |
|        | incorrectMessageLength                     | 13        | RC_IML    |
|        | conditionsNotCorrectOrRequestSequenceError | 22        | RC_CNC    |
|        | invalidKey                                 | 35        | RC_IK     |
|        | exceededNumberOfAttempts                   | 36        | RC_ENA    |
|        | requestCorrectlyReceived-ResponsePending)  | 78        | RC_RCR_RP |
| #8     | Checksum                                   | 00-FF     | CS        |

## 6. DATA TRANSMISSION SERVICES

The services available are detailed in the following table:

Table 24

**Data transmission services**

| Service name          | Description                                                                                               |
|-----------------------|-----------------------------------------------------------------------------------------------------------|
| ReadDataByIdentifier  | The client requests the transmission of the current value of a record with access by recordDataIdentifier |
| WriteDataByIdentifier | The client requests to write a record accessed by recordDataIdentifier                                    |

## 6.1. ReadDataByIdentifier service

## 6.1.1. Message description

CPR\_050 The ReadDataByIdentifier service is used by the client to request data record values from a server. The data are identified by a recordDataIdentifier. It is the VU manufacturer's responsibility that the server conditions are met when performing this service.

## 6.1.2. Message format

CPR\_051 The message formats for the ReadDataByIdentifier primitives are detailed in the following tables:

Table 25

**ReadDataByIdentifier request message**

| Byte #    | Parameter Name                                 | Hex value | Mnemonic |
|-----------|------------------------------------------------|-----------|----------|
| #1        | Format byte — physical addressing              | 80        | FMT      |
| #2        | Target address byte                            | EE        | TGT      |
| #3        | Source address byte                            | tt        | SRC      |
| #4        | Additional length byte                         | 03        | LEN      |
| #5        | ReadDataByIdentifier Request Service Id        | 22        | RDBI     |
| #6 and #7 | recordDataIdentifier = (a valor from Table 28) | xxxx      | RDI_...  |
| #8        | Checksum                                       | 00-FF     | CS       |

Table 26

**ReadDataByIdentifier positive response message**

| Byte #     | Parameter Name                                                         | Hex value     | Mnemonic                      |
|------------|------------------------------------------------------------------------|---------------|-------------------------------|
| #1         | Format byte — physical addressing                                      | 80            | FMT                           |
| #2         | Target address byte                                                    | tt            | TGT                           |
| #3         | Source address byte                                                    | EE            | SRC                           |
| #4         | Additional length byte                                                 | m+3           | LEN                           |
| #5         | ReadDataByIdentifier Positive Response Service Id                      | 62            | RDBIPR                        |
| #6 and #7  | recordDataIdentifier = (the same value as bytes #6 and #7<br>Table 25) | xxxx          | RDI_...                       |
| #8 to #m+7 | dataRecord() = (data#1<br>:<br>data#m)                                 | xx<br>:<br>xx | DREC_DATA1<br>:<br>DREC_DATAm |
| #m+8       | Checksum                                                               | 00-FF         | CS                            |

Table 27

**ReadDataByIdentifier negative response message**

| Byte # | Parameter Name                                                                       | Hex value      | Mnemonic                    |
|--------|--------------------------------------------------------------------------------------|----------------|-----------------------------|
| #1     | Format byte — physical addressing                                                    | 80             | FMT                         |
| #2     | Target address byte                                                                  | tt             | TGT                         |
| #3     | Source address byte                                                                  | EE             | SRC                         |
| #4     | Additional length byte                                                               | 03             | LEN                         |
| #5     | NegativeResponse Service Id                                                          | 7F             | NR                          |
| #6     | ReadDataByIdentifier Request Service Id                                              | 22             | RDBI                        |
| #7     | ResponseCode = (requestOutOfRange<br>incorrectMessageLength<br>conditionsNotCorrect) | 31<br>13<br>22 | RC_ROOR<br>RC_IML<br>RC_CNC |
| #8     | Checksum                                                                             | 00-FF          | CS                          |

**6.1.3. Parameter definition**

CPR\_052 The parameter recordDataIdentifier (RDI\_) in the ReadDataByIdentifier request message identifies a data record.

CPR\_053 recordDataIdentifier values defined by this document are shown in the table below.

The recordDataIdentifier table consists of four columns and multiple lines.

- The first column (Hex) includes the “hex value” assigned to the recordDataIdentifier specified in the third column.
- The second column (Data element) specifies the data element of Appendix 1 on which the recordDataIdentifier is based (transcoding is sometimes necessary).
- The third column (Description) specifies the corresponding recordDataIdentifier name.
- The fourth column (Mnemonic) specifies the mnemonic of this recordDataIdentifier.

Table 28

**Definition of recordDataIdentifier values**

| Hex  | Data element                    | recordDataIdentifier Name<br>(see format in Section 8.2) | Mnemonic  |
|------|---------------------------------|----------------------------------------------------------|-----------|
| F90B | CurrentDateTime                 | TimeDate                                                 | RDI_TD    |
| F912 | HighResOdometer                 | HighResolutionTotalVehicleDistance                       | RDI_HRTVD |
| F918 | K-ConstantOfRecordingEquipment  | Kfactor                                                  | RDI_KF    |
| F91C | L-TyreCircumference             | LfactorTyreCircumference                                 | RDI_LF    |
| F91D | W-VehicleCharacteristicConstant | WvehicleCharacteristicFactor                             | RDI_WVCF  |
| F921 | TyreSize                        | TyreSize                                                 | RDI_TS    |
| F922 | nextCalibrationDate             | NextCalibrationDate                                      | RDI_NCD   |
| F92C | SpeedAuthorised                 | SpeedAuthorised                                          | RDI_SA    |
| F97D | vehicleRegistrationNation       | RegisteringMemberState                                   | RDI_RMS   |
| F97E | VehicleRegistrationNumber       | VehicleRegistrationNumber                                | RDI_VRN   |
| F190 | VehicleIdentificationNumber     | VIN                                                      | RDI_VIN   |

CPR\_054 The parameter dataRecord (DREC\_) is used by the ReadDataByIdentifier positive response message to provide the data record value identified by the recordDataIdentifier to the client (tester). Data formats are specified in Section 8. Additional user optional dataRecords including VU specific input, internal and output data may be implemented, but are not defined in this document.

**6.2. WriteDataByIdentifier service****6.2.1. Message description**

CPR\_056 The WriteDataByIdentifier service is used by the client to write data record values to a server. The data are identified by a recordDataIdentifier. It is the VU manufacturer's responsibility that the server conditions are met when performing this service. To update the parameters listed in Table 28 the VU must be in CALIBRATION mode.

**6.2.2. Message format**

CPR\_057 The message formats for the WriteDataByIdentifier primitives are detailed in the following tables:

Table 29

**WriteDataByIdentifier request message**

| Byte #     | Parameter Name                                 | Hex value     | Mnemonic                      |
|------------|------------------------------------------------|---------------|-------------------------------|
| #1         | Format byte — physical addressing              | 80            | FMT                           |
| #2         | Target address byte                            | EE            | TGT                           |
| #3         | Source address byte                            | tt            | SRC                           |
| #4         | Additional length byte                         | m+3           | LEN                           |
| #5         | WriteDataByIdentifier request service Id       | 2E            | WDBI                          |
| #6 and #7  | recordDataIdentifier = (a value from Table 28) | xxxx          | RDI_...                       |
| #8 to #m+7 | dataRecord() = (data#1<br>:<br>data#m)         | xx<br>:<br>xx | DREC_DATA1<br>:<br>DREC_DATAm |
| #m+8       | Checksum                                       | 00-FF         | CS                            |

Table 30

**WriteDataByIdentifier positive response message**

| Byte #    | Parameter Name                                                      | Hex value | Mnemonic |
|-----------|---------------------------------------------------------------------|-----------|----------|
| #1        | Format byte — physical addressing                                   | 80        | FMT      |
| #2        | Target address byte                                                 | tt        | TGT      |
| #3        | Source address byte                                                 | EE        | SRC      |
| #4        | Additional length byte                                              | 03        | LEN      |
| #5        | WriteDataByIdentifier positive response service Id                  | 6E        | WDBIPR   |
| #6 and #7 | recordDataIdentifier = (the same value as bytes #6 and #7 Table 29) | xxxx      | RDI_...  |
| #8        | Checksum                                                            | 00-FF     | CS       |

Table 31

**WriteDataByIdentifier negative response message**

| Byte # | Parameter Name                           | Hex value | Mnemonic |
|--------|------------------------------------------|-----------|----------|
| #1     | Format byte — physical addressing        | 80        | FMT      |
| #2     | Target address byte                      | tt        | TGT      |
| #3     | Source address byte                      | EE        | SRC      |
| #4     | Additional length byte                   | 03        | LEN      |
| #5     | NegativeResponse Service Id              | 7F        | NR       |
| #6     | WriteDataByIdentifier request service Id | 2E        | WDBI     |
| #7     | ResponseCode = (requestOutOfRange        | 31        | RC_ROOR  |
|        | incorrectMessageLength                   | 13        | RC_IML   |
|        | conditionsNotCorrect)                    | 22        | RC_CNC   |
| #8     | Checksum                                 | 00-FF     | CS       |

**6.2.3. Parameter definition**

The parameter recordDataIdentifier (RDI\_) is defined in Table 28.

The parameter dataRecord (DREC\_) is used by the WriteDataByIdentifier request message to provide the data record values identified by the recordDataIdentifier to the server (VU). Data formats are specified in Section 8.

**7. CONTROL OF TEST PULSES — INPUT/OUTPUT CONTROL FUNCTIONAL UNIT**

The services available are detailed in the following table:

Table 32

**Input/Output control functional unit**

| Service name                   | Description                                                               |
|--------------------------------|---------------------------------------------------------------------------|
| InputOutputControlByIdentifier | The client requests the control of an input/output specific to the server |

**7.1. Message description****7.1.1. Message description**

There is a connection via the front connector which allows test pulses to be controlled or monitored using a suitable tester.



CPR\_058 This calibration I/O signal line can be configured by K-line command using the InputOutputControlByIdentifier service to select the required input or output function for the line. The available states of the line are:

- disabled,
- speedSignalInput, where the calibration I/O signal line is used to input a speed signal (test signal) replacing the motion sensor speed signal,
- realTimeSpeedSignalOutputSensor, where the calibration I/O signal line is used to output the speed signal of the motion sensor,
- RTCOutput, where the calibration I/O signal line is used to output the UTC clock signal.

CPR\_059 The vehicle unit must have entered an adjustment session and must be in CALIBRATION mode to configure the state of the line. On exit of the adjustment session or of the CALIBRATION mode the vehicle unit must ensure the calibration I/O signal line is returned to the “disabled” (default) state.

CPR\_060 If speed pulses are received at the real time speed signal input line of the VU while the calibration I/O signal line is set to input then the calibration I/O signal line shall be set to output or returned to the disabled state.

CPR\_061 The sequence shall be:

- establish communications by StartCommunication Service
- enter an adjustment session by StartDiagnosticSession Service and be in CALIBRATION mode of operation (the order of these two operations is not important).
- change the state of the output by InputOutputControlByIdentifier Service.

### 7.1.2. Message format

CPR\_062 The message formats for the InputOutputControlByIdentifier primitives are detailed in the following tables:

Table 33

#### InputOutputControlByIdentifier request message

| Byte #         | Parameter name                                                                                                                               | Hex value | Mnemonic                      |
|----------------|----------------------------------------------------------------------------------------------------------------------------------------------|-----------|-------------------------------|
| #1             | Format byte — physical addressing                                                                                                            | 80        | FMT                           |
| #2             | Target address byte                                                                                                                          | EE        | TGT                           |
| #3             | Source address byte                                                                                                                          | tt        | SRC                           |
| #4             | Additional length byte                                                                                                                       | xx        | LEN                           |
| #5             | InputOutputControlByIdentifier request Sid                                                                                                   | 2F        | IOCBI                         |
| #6 and #7      | InputOutputIdentifier = (CalibrationInputOutput)                                                                                             | F960      | IOI_CIO                       |
| #8 or #8 to #9 | ControlOptionRecord = (<br>inputOutputControlParameter — one value from Table 36<br>controlState — one value from Table 38 (see note below)) | xx<br>xx  | COR_...<br>IOCP_...<br>CS_... |
| #9 or #10      | Checksum                                                                                                                                     | 00-FF     | CS                            |

Note: The controlState parameter is present only in some cases (see 7.1.3).

Table 34

**InputOutputControlByIdentifier positive response message**

| Byte #         | Parameter Name                                                                                                                                            | Hex value | Mnemonic                |
|----------------|-----------------------------------------------------------------------------------------------------------------------------------------------------------|-----------|-------------------------|
| #1             | Format byte — physical addressing                                                                                                                         | 80        | FMT                     |
| #2             | Target address byte                                                                                                                                       | tt        | TGT                     |
| #3             | Source address byte                                                                                                                                       | EE        | SRC                     |
| #4             | Additional length byte                                                                                                                                    | xx        | LEN                     |
| #5             | inputOutputControlByIdentifier positive response SId                                                                                                      | 6F        | IOCBIPR                 |
| #6 and #7      | inputOutputIdentifier = (CalibrationInputOutput)                                                                                                          | F960      | IOI_CIO                 |
| #8 or #8 to #9 | controlStatusRecord = (<br>inputOutputControlParameter (same value as byte #8 Table 33)<br>controlState (same value as byte #9 Table 33)) (if applicable) | xx<br>xx  | CSR_<br>IOCP_<br>CS_... |
| #9 or #10      | Checksum                                                                                                                                                  | 00-FF     | CS                      |

Table 35

**InputOutputControlByIdentifier negative response message**

| Byte # | Parameter Name                                                                                                          | Hex value            | Mnemonic                               |
|--------|-------------------------------------------------------------------------------------------------------------------------|----------------------|----------------------------------------|
| #1     | Format byte — physical addressing                                                                                       | 80                   | FMT                                    |
| #2     | Target address byte                                                                                                     | tt                   | TGT                                    |
| #3     | Source address byte                                                                                                     | EE                   | SRC                                    |
| #4     | Additional length byte                                                                                                  | 03                   | LEN                                    |
| #5     | negativeResponse Service Id                                                                                             | 7F                   | NR                                     |
| #6     | inputOutputControlByIdentifier request SId                                                                              | 2F                   | IOCBi                                  |
| #7     | responseCode = (<br>incorrectMessageLength<br>conditionsNotCorrect<br>requestOutOfRange<br>deviceControlLimitsExceeded) | 13<br>22<br>31<br>7A | RC_IML<br>RC_CNC<br>RC_ROOR<br>RC_DCLE |
| #8     | Checksum                                                                                                                | 00-FF                | CS                                     |

**7.1.3. Parameter definition**

CPR\_064 The parameter inputOutputControlParameter (IOCP\_) is defined in the following table:

Table 36

**Definition of inputOutputControlParameter values**

| Hex | Description                                                                                                                                                                             | Mnemonic |
|-----|-----------------------------------------------------------------------------------------------------------------------------------------------------------------------------------------|----------|
| 00  | ReturnControlToECU<br>This value shall indicate to the server (VU) that the tester does no longer have control about the calibration I/O signal line.                                   | RCTECU   |
| 01  | ResetToDefault<br>This value shall indicate to the server (VU) that it is requested to reset the calibration I/O signal line to its default state.                                      | RTD      |
| 03  | ShortTermAdjustment<br>This value shall indicate to the server (VU) that it is requested to adjust the calibration I/O signal line to the value included in the controlState parameter. | STA      |

CPR\_065 The parameter controlState is present only when the inputOutputControlParameter is set to ShortTermAdjustment and is defined in the following table:

Table 37

**Definition of controlState values**

| Mode    | Hex value | Description                                                    |
|---------|-----------|----------------------------------------------------------------|
| Disable | 00        | I/O line is disabled (default state)                           |
| Enable  | 01        | Enable calibration I/O line as speedSignalInput                |
| Enable  | 02        | Enable calibration I/O line as realTimeSpeedSignalOutputSensor |
| Enable  | 03        | Enable calibration I/O line as RTCOutput                       |

## 8. DATARECORDS FORMATS

This section details:

- general rules that shall be applied to ranges of parameters transmitted by the vehicle unit to the tester,
- formats that shall be used for data transferred via the Data Transmission Services described in Section 6.

CPR\_067 All parameters identified shall be supported by the VU.

CPR\_068 Data transmitted by the VU to the tester in response to a request message shall be of the measured type (i.e. current value of the requested parameter as measured or observed by the VU).

### 8.1. Transmitted parameter ranges

CPR\_069 Table 38 defines the ranges used to determine the validity of a transmitted parameter.

CPR\_070 The values in the range “error indicator” provide a means for the vehicle unit to immediately indicate that valid parametric data is not currently available due to some type of error in the recording equipment.

CPR\_071 The values in the range “not available” provide a means for the vehicle unit to transmit a message which contains a parameter that is not available or not supported in that module. The values in the range “not requested” provide a means for a device to transmit a command message and identify those parameters where no response is expected from the receiving device.

CPR\_072 If a component failure prevents the transmission of valid data for a parameter, the error indicator as described in Table 38 should be used in place of that parameter's data. However, if the measured or calculated data has yielded a value that is valid yet exceeds the defined parameter range, the error indicator should not be used. The data should be transmitted using the appropriate minimum or maximum parameter value.

Table 38

**dataRecords ranges**

| Range Name                               | 1 byte<br>(Hex value) | 2 bytes<br>(Hex value) | 4 bytes<br>(Hex value) | ASCII    |
|------------------------------------------|-----------------------|------------------------|------------------------|----------|
| Valid signal                             | 00 to FA              | 0000 to FAFF           | 00000000 to FFFFFFFF   | 1 to 254 |
| Parameter specific indicator             | FB                    | FB00 to FBFF           | FB000000 to FBFFFFFF   | none     |
| Reserved range for future indicator bits | FC to FD              | FC00 to FDFF           | FC000000 to FDFFFFFF   | none     |
| Error indicator                          | FE                    | FE00 to FEFF           | FE000000 to FEFFFFFF   | 0        |
| Not available or not requested           | FF                    | FF00 to FFFF           | FF000000 to FFFFFFFF   | FF       |

CPR\_073 For parameters coded in ASCII, the ASCII character "\*" is reserved as a delimiter.

**8.2. dataRecords formats**

Table 40 to Table 44 below detail the formats that shall be used via the ReadDataByIdentifier and WriteDataByIdentifier Services.

CPR\_074 Table 40 provides the length, resolution and operating range for each parameter identified by its recordDataIdentifier:

Table 39

**Format of dataRecords**

| Parameter Name                     | Data length<br>(bytes) | Resolution                                    | Operating range      |
|------------------------------------|------------------------|-----------------------------------------------|----------------------|
| TimeDate                           | 8                      | See details in Table 40                       |                      |
| HighResolutionTotalVehicleDistance | 4                      | 5 m/bit gain,<br>0 m offset                   | 0 to + 21 055 406 km |
| Kfactor                            | 2                      | 0,001 pulse/m/bit gain,<br>offset 0           | 0 to 64,255 pulse/m  |
| LfactorTyreCircumference           | 2                      | 0,125 10 <sup>-3</sup> /bit gain,<br>0 offset | 0 to 8 031 m         |
| WvehicleCharacteristicFactor       | 2                      | 0,001 pulse/m/bit gain,<br>0 offset           | 0 to 64,255 pulse/m  |
| TyreSize                           | 15                     | ASCII                                         | ASCII                |
| NextCalibrationDate                | 3                      | See details in Table 41                       |                      |
| SpeedAuthorised                    | 2                      | 1/256 km/h/bit gain,<br>0 offset              | 0 to 250 996 km/h    |
| RegisteringMemberState             | 3                      | ASCII                                         | ASCII                |
| VehicleRegistrationNumber          | 14                     | See details in Table 44                       |                      |
| VIN                                | 17                     | ASCII                                         | ASCII                |

CPR\_075 Table 40 details the formats of the different bytes of the TimeDate parameter:

Table 40

**Detailed format of TimeDate (recordDataIdentifier value # F00B)**

| Byte | Parameter definition | Resolution                                                      | Operating range   |
|------|----------------------|-----------------------------------------------------------------|-------------------|
| 1    | Seconds              | 0,25 s/bit gain,<br>0 s offset                                  | 0 to 59,75 s      |
| 2    | Minutes              | 1 min/bit gain,<br>0 min offset                                 | 0 to 59 min       |
| 3    | Hours                | 1 h/bit gain,<br>0 h offset                                     | 0 to 23 h         |
| 4    | Month                | 1 month/bit gain,<br>0 month offset                             | 1 to 12 month     |
| 5    | Day                  | 0,25 day/bit gain,<br>0 day offset (see Note below<br>Table 41) | 0,25 to 31,75 day |
| 6    | Year                 | 1 year/bit gain, +1985 year offset<br>(see Note below Table 41) | 1985 to 2235 year |
| 7    | Local Minute Offset  | 1 min/bit gain,<br>- 125 min offset                             | - 59 to 59 min    |
| 8    | Local Hour Offset    | 1 h/bit gain,<br>- 125 offset                                   | - 23 to + 23 h    |

CPR\_076 Table 41 details the formats of the different bytes of the NextCalibrationDate parameter:

Table 41

**Detailed format of NextCalibrationDate (recordDataIdentifier value # F022)**

| Byte | Parameter definition | Resolution                                             | Operating range   |
|------|----------------------|--------------------------------------------------------|-------------------|
| 1    | Month                | 1 month/bit gain,<br>0 month offset                    | 1 to 12 month     |
| 2    | Day                  | 0,25 day/bit gain,<br>0 day offset (see Note below)    | 0,25 to 31,75 day |
| 3    | Year                 | 1 Year/bit gain,<br>+1985 year offset (see Note below) | 1985 to 2235 year |

Note concerning the use of the "Day" parameter:

1. A value of 0 for the date is null. The values 1, 2, 3, and 4 are used to identify the first day of the month; 5, 6, 7, and 8 identify the second day of the month; etc.
2. This parameter does not influence or change the hours parameter above.

Note concerning the use of byte "Year" parameter:

A value of 0 for the year identifies the year 1985; a value of 1 identifies 1986; etc.

CPR\_078 Table 42 details the formats of the different bytes of the VehicleRegistrationNumber parameter:

Table 42

**Detailed format of VehicleRegistrationNumber (recordDataIdentifier value # F07E)**

| Byte    | Parameter definition                                      | Resolution | Operating range |
|---------|-----------------------------------------------------------|------------|-----------------|
| 1       | Code Page (as defined in<br>Appendix 1)                   | ASCII      | 01 to 0A        |
| 2 to 14 | Vehicle Registration Number (as<br>defined in Appendix 1) | ASCII      | ASCII           |

*Appendix 9***TYPE APPROVAL — LIST OF MINIMUM REQUIRED TESTS**

## CONTENTS

|      |                                         |     |
|------|-----------------------------------------|-----|
| 1.   | Introduction .....                      | 191 |
| 1.1. | Type approval .....                     | 191 |
| 1.2. | References .....                        | 191 |
| 2.   | Vehicle unit functional tests .....     | 192 |
| 3.   | Motion sensor functional tests .....    | 195 |
| 4.   | Tachograph cards functional tests ..... | 197 |
| 5.   | Interoperability tests .....            | 198 |

## 1. INTRODUCTION

### 1.1. Type approval

The EEC type approval for a recording equipment (or component) or a tachograph card is based on:

- a security certification, performed by an ITSEC authority, against a security target fully compliant with Appendix 10 to this Annex,
- a functional certification performed by a Member State authority certifying that the item tested fulfils the requirements of this Annex in terms of functions performed, measurement accuracy and environmental characteristics,
- an interoperability certification performed by the competent body certifying that the recording equipment (or tachograph card) is fully interoperable with the necessary tachograph card (or recording equipment) models (see Chapter VIII of this Annex).

This Appendix specifies which tests, as a minimum, must be performed by a Member State authority during the functional tests, and which tests, as a minimum, must be performed by the competent body during the interoperability tests. Procedures to follow to carry out the tests or the type of tests are not specified further.

The security certification aspects are not covered by this Appendix. If some tests requested for type approval are performed during the security evaluation and certification process, then these tests do not need to be performed again. In this case, only the results of these security tests may be inspected. For information, the requirements expected to be tested (or closely related to tests expected to be performed) during the security certification, are marked with a "\*" in this Appendix.

This Appendix considers separately the type approval of the motion sensor and of the vehicle unit, as components of the recording equipment. Interoperability between every model of motion sensor and every model of vehicle unit is not required, therefore the type approval for a motion sensor can be granted only in combination with the type approval of a vehicle unit and vice versa.

### 1.2. References

The following references are used in this Appendix:

- |               |                                                                                                                                                                                                                                       |
|---------------|---------------------------------------------------------------------------------------------------------------------------------------------------------------------------------------------------------------------------------------|
| IEC 68-2-1    | Environmental testing — Part 2: Tests — Tests A: Cold. 1990 + Amendment 2: 1994.                                                                                                                                                      |
| IEC 68-2-2    | Environmental testing — Part 2: Tests — Tests B: Dry heat. 1974 + Amendment 2: 1994.                                                                                                                                                  |
| IEC 68-2-6    | Basic environmental testing procedures — Test methods — Test Fc and guidance: Vibration (sinusoidal). 6th edition: 1985.                                                                                                              |
| IEC 68-2-14   | Basic environmental testing procedures — Test methods — Test N: Change of temperature. Modification 1: 1986.                                                                                                                          |
| IEC 68-2-27   | Basic environmental testing procedures — Test methods — Test Ea and guidance: Shock. Edition 3: 1987.                                                                                                                                 |
| IEC 68-2-30   | Basic environmental testing procedures — Test methods — Test Db and guidance: Damp heat, cyclic (12 + 12 — hour cycle). Modification 1: 1985.                                                                                         |
| IEC 68-2-35   | Basic environmental testing procedure — Test methods — Test Fda: Random vibration wide band — Reproducibility High. Modification 1: 1983.                                                                                             |
| IEC 529       | Degrees of protection provided by enclosures (IP code). Edition 2: 1989.                                                                                                                                                              |
| IEC 61000-4-2 | Electromagnetic Compatibility (EMC) — Testing and measurement techniques — Electrostatic discharge immunity test: 1995/Amendment 1: 1998.                                                                                             |
| ISO 7637-1    | Road vehicles — Electrical disturbance by conduction and coupling — Part 1: Passenger cars and light commercial vehicles with nominal 12 V supply voltage — Electrical transient conduction along supply lines only. Edition 2: 1990. |

- ISO 7637-2 Road vehicles — Electrical disturbance by conduction and coupling — Part 1: Passenger cars and light commercial vehicles with nominal 12 V supply voltage — Electrical transient conduction along supply lines only. Edition 2: 1990.
- ISO 7637-3 Road vehicles — Electrical disturbance by conduction and coupling — Part 3: Vehicles with 12 V or 24 V supply voltage — Electrical transient transmission by capacitive and inductive coupling via lines other than supply lines. First Edition: 1995 + Cor 1: 1995.
- ISO/IEC 7816-1 Identification cards — Integrated circuit(s) cards with contacts — Part 1: Physical characteristics. First edition: 1998.
- ISO/IEC 7816-2 Information technology — Identification cards — Integrated circuit(s) cards with contacts — Part 2: Dimensions and location of the contacts. First edition: 1999.
- ISO/IEC 7816-3 Information technology — Identification cards — Integrated circuit(s) cards with contacts — Part 3: Electronic signals and transmission protocol. Edition 2: 1997.
- ISO/IEC 10373 Identification cards — Test methods. First edition: 1993.

## 2. VEHICLE UNIT FUNCTIONAL TESTS

| No    | Test                                       | Description                                                                        | Related requirements                   |
|-------|--------------------------------------------|------------------------------------------------------------------------------------|----------------------------------------|
| 1.    | <b>Administrative examination</b>          |                                                                                    |                                        |
| 1.1.  | Documentation                              | Correctness of documentation                                                       |                                        |
| 1.2.  | Manufacturer test results                  | Results of manufacturer test performed during integration.<br>Paper demonstrations | 070, 071, 073                          |
| 2.    | <b>Visual inspection</b>                   |                                                                                    |                                        |
| 2.1.  | Compliance with documentation              |                                                                                    |                                        |
| 2.2.  | Identification/markings                    |                                                                                    | 168, 169                               |
| 2.3.  | Materials                                  |                                                                                    | 163 to 167                             |
| 2.4.  | Sealing                                    |                                                                                    | 251                                    |
| 2.5.  | External interfaces                        |                                                                                    |                                        |
| 3.    | <b>Functional tests</b>                    |                                                                                    |                                        |
| 3.1.  | Functions provided                         |                                                                                    | 002, 004, 244                          |
| 3.2.  | Modes of operation                         |                                                                                    | 006*, 007*,<br>008*, 009*, 106,<br>107 |
| 3.3.  | Functions and data access rights           |                                                                                    | 010*, 011*, 240,<br>246, 247           |
| 3.4.  | Monitoring cards insertion and withdrawal  |                                                                                    | 013, 014, 015*,<br>016*, 106           |
| 3.5.  | Speed and distance measurement             |                                                                                    | 017 to 026                             |
| 3.6.  | Time measurement (test performed at 20 °C) |                                                                                    | 027 to 032                             |
| 3.7.  | Monitoring driver activities               |                                                                                    | 033 to 043, 106                        |
| 3.8.  | Monitoring driving status                  |                                                                                    | 044, 045, 106                          |
| 3.9.  | Manual entries                             |                                                                                    | 046 to 050b                            |
| 3.10. | Company locks management                   |                                                                                    | 051 to 055                             |
| 3.11. | Monitoring control activities              |                                                                                    | 056, 057                               |
| 3.12. | Detection of events and/or faults          |                                                                                    | 059 to 069, 106                        |



| No    | Test                                       | Description | Related requirements                                       |
|-------|--------------------------------------------|-------------|------------------------------------------------------------|
| 3.13. | Equipment identification data              |             | 075*, 076*, 079                                            |
| 3.14. | Driver card insertion and withdrawal data  |             | 081* to 083*                                               |
| 3.15. | Driver activity data                       |             | 084* to 086*                                               |
| 3.16. | Places data                                |             | 087* to 089*                                               |
| 3.17. | Odometer data                              |             | 090* to 092*                                               |
| 3.18. | Detailed speed data                        |             | 093*                                                       |
| 3.19. | Events data                                |             | 094*, 095                                                  |
| 3.20. | Faults data                                |             | 096*                                                       |
| 3.21. | Calibration data                           |             | 097*, 098*                                                 |
| 3.22. | Time adjustment data                       |             | 100*, 101*                                                 |
| 3.23. | Control activity data                      |             | 102*, 103*                                                 |
| 3.24. | Company locks data                         |             | 104*                                                       |
| 3.25. | Download activity data                     |             | 105*                                                       |
| 3.26. | Specific conditions data                   |             | 105a*, 105b*                                               |
| 3.27. | Recording and storing on tachographs cards |             | 108, 109*,<br>109a*, 110*,<br>111, 112                     |
| 3.28. | Displaying                                 |             | 072, 106, 113 to<br>128, PIC_001,<br>DIS_001               |
| 3.29. | Printing                                   |             | 072, 106, 129 to<br>138, PIC_001,<br>PRT_001 to<br>PRT_012 |
| 3.30. | Warning                                    |             | 106, 139 to 148,<br>PIC_001                                |
| 3.31. | Data downloading to external media         |             | 072, 106, 149 to<br>151                                    |
| 3.32. | Output data to additional external devices |             | 152, 153                                                   |
| 3.33. | Calibration                                |             | 154*, 155*,<br>156*, 245                                   |
| 3.34. | Time adjustment                            |             | 157*, 158*                                                 |
| 3.35. | Non-interference of additional functions   |             | 003, 269                                                   |

| No   | Test                                        | Description                                                                                                                                                                                                                                                                                                                                                                                                                                                                                                                                                                                                                                                                                                                                                                                                                                                                                    | Related requirements |
|------|---------------------------------------------|------------------------------------------------------------------------------------------------------------------------------------------------------------------------------------------------------------------------------------------------------------------------------------------------------------------------------------------------------------------------------------------------------------------------------------------------------------------------------------------------------------------------------------------------------------------------------------------------------------------------------------------------------------------------------------------------------------------------------------------------------------------------------------------------------------------------------------------------------------------------------------------------|----------------------|
| 4.   | <b>Environmental tests</b>                  |                                                                                                                                                                                                                                                                                                                                                                                                                                                                                                                                                                                                                                                                                                                                                                                                                                                                                                |                      |
| 4.1. | Temperature                                 | <p>Verify functionality through:</p> <ul style="list-style-type: none"> <li>— IEC 68-2-1, test Ad, with a test duration of 72 hours at the lower temperature (- 20 °C), 1 hour operating, 1 hour non operating.</li> <li>— IEC 68-2-2, test Bd, with a test duration of 72 hours at the higher temperature (+ 70 °C), 1 hour operating, 1 hour non operating</li> </ul> <p>Temperature cycles: verify that the vehicle unit can withstand rapid changes in the environment temperature through IEC 68-2-14 test Na, 20 cycles, each with temperature varying from the lower temperature (- 20 °C) to the higher temperature (+ 70 °C) and a 2 hours stay at both the lower and the higher temperature</p> <p>A reduced set of tests (among those defined in section 3 of this table) can be carried out at the lower temperature, the higher temperature and during the temperature cycles</p> | 159                  |
| 4.2. | Humidity                                    | <p>Verify that the vehicle unit can withstand a cyclic damp (heat test) through IEC 68-2-30, test Db, six 24 hours cycles, each temperature varying from + 25 °C to + 55 °C and a relative humidity of 97 % at + 25 °C and equal to 93 % at + 55 °C</p>                                                                                                                                                                                                                                                                                                                                                                                                                                                                                                                                                                                                                                        | 160                  |
| 4.3. | Vibration                                   | <p>1. Sinusoidal vibrations:</p> <p>verify that the vehicle unit can withstand sinusoidal vibrations with the following characteristics:</p> <p>constant displacement between 5 and 11 Hz: 10 mm peak</p> <p>constant acceleration between 11 and 300 Hz: 5 g</p> <p>This requirement is verified through IEC 68-2-6, test Fc, with a minimum test duration of 3 × 12 hours (12 hours per axis)</p> <p>2. Random vibrations:</p> <p>verify that the vehicle unit can withstand random vibrations with the following characteristics:</p> <p>frequency 5-150 Hz, level 0,02 g<sup>2</sup>/Hz</p> <p>This requirement is verified through IEC 68-2-35, test Ffda, with a minimum test duration of 3 × 12 hours (12 hours per axis), 1 hour operating, 1 hour non operating</p> <p>The two tests described above are performed on two different samples of the equipment type being tested</p>    | 163                  |
| 4.4. | Protection against water and foreign bodies | <p>Verify that the vehicle unit protection index according to IEC 529 is at least IP 40, when mounted in operating conditions in a vehicle</p>                                                                                                                                                                                                                                                                                                                                                                                                                                                                                                                                                                                                                                                                                                                                                 | 164, 165             |
| 4.5. | Over-voltage protection                     | <p>Verify that the vehicle unit can withstand a power supply of:</p> <p>24V versions: 34 V at + 40 °C 1 hour</p> <p>12V versions: 17 V at + 40 °C 1 hour</p>                                                                                                                                                                                                                                                                                                                                                                                                                                                                                                                                                                                                                                                                                                                                   | 161                  |
| 4.6. | Reverse polarity protection                 | <p>Verify that the vehicle unit can withstand an inversion of its power supply</p>                                                                                                                                                                                                                                                                                                                                                                                                                                                                                                                                                                                                                                                                                                                                                                                                             | 161                  |

| No   | Test                                               | Description                                                                                                                                                                                                                                                                                                                                                                                                                                                                                                                                                                                                                                                                                                                                                                                                                                                            | Related requirements |
|------|----------------------------------------------------|------------------------------------------------------------------------------------------------------------------------------------------------------------------------------------------------------------------------------------------------------------------------------------------------------------------------------------------------------------------------------------------------------------------------------------------------------------------------------------------------------------------------------------------------------------------------------------------------------------------------------------------------------------------------------------------------------------------------------------------------------------------------------------------------------------------------------------------------------------------------|----------------------|
| 4.7. | Short-circuit protection                           | Verify that input output signals are protected against short circuits to power supply and ground                                                                                                                                                                                                                                                                                                                                                                                                                                                                                                                                                                                                                                                                                                                                                                       | 161                  |
| 5.   | <b>EMC tests</b>                                   |                                                                                                                                                                                                                                                                                                                                                                                                                                                                                                                                                                                                                                                                                                                                                                                                                                                                        |                      |
| 5.1. | Radiated emissions and susceptibility              | Compliance with Directive 95/54/EEC                                                                                                                                                                                                                                                                                                                                                                                                                                                                                                                                                                                                                                                                                                                                                                                                                                    | 162                  |
| 5.2. | Electrostatic discharge                            | Compliance with IEC 61000-4-2, $\pm 2$ kV (level 1)                                                                                                                                                                                                                                                                                                                                                                                                                                                                                                                                                                                                                                                                                                                                                                                                                    | 162                  |
| 5.3. | Conducted transient susceptibility on power supply | For 24V versions: compliance with ISO 7637-2:<br>pulse 1a: $V_s = -100$ V, $R_i = 10$ ohms<br>pulse 2: $V_s = +100$ V, $R_i = 10$ ohms<br>pulse 3a: $V_s = -100$ V, $R_i = 50$ ohms<br>pulse 3b: $V_s = +100$ V, $R_i = 50$ ohms<br>pulse 4: $V_s = -16$ V $V_a = -12$ V, $t_6=100$ ms<br>pulse 5: $V_s = +120$ V, $R_i = 2,2$ ohms, $t_d = 250$ ms<br>For 12V versions: compliance with ISO 7637-1:<br>pulse 1: $V_s = -100$ V, $R_i = 10$ ohms<br>pulse 2: $V_s = +100$ V, $R_i = 10$ ohms<br>pulse 3a: $V_s = -100$ V, $R_i = 50$ ohms<br>pulse 3b: $V_s = +100$ V, $R_i = 50$ ohms<br>pulse 4: $V_s = -6$ V, $V_a = -5$ V, $t_6 = 15$ ms<br>pulse 5: $V_s = +65$ V, $R_i = 3$ ohms, $t_d = 100$ ms<br>Pulse 5 shall be tested only for vehicle units designed to be installed in vehicles for which no external common protection against load dump is implemented | 162                  |

## 3. MOTION SENSOR FUNCTIONAL TESTS

| No   | Test                                 | Description                  | Related requirements |
|------|--------------------------------------|------------------------------|----------------------|
| 1.   | <b>Administrative examination</b>    |                              |                      |
| 1.1. | Documentation                        | Correctness of documentation |                      |
| 2.   | <b>Visual inspection</b>             |                              |                      |
| 2.1. | Compliance with documentation        |                              |                      |
| 2.2. | Identification/markings              |                              | 169, 170             |
| 2.3. | Materials                            |                              | 163 to 167           |
| 2.4. | Sealing                              |                              | 251                  |
| 3.   | <b>Functional tests</b>              |                              |                      |
| 3.1. | Sensor identification data           |                              | 077*                 |
| 3.2. | Motion sensor — vehicle unit pairing |                              | 099*, 155            |
| 3.3. | Motion detection                     |                              |                      |
|      | Motion measurement accuracy          |                              | 022 to 026           |

| No   | Test                                              | Description                                                                                                                                                                                                                                                                                                                                                                                                                           | Related requirements |
|------|---------------------------------------------------|---------------------------------------------------------------------------------------------------------------------------------------------------------------------------------------------------------------------------------------------------------------------------------------------------------------------------------------------------------------------------------------------------------------------------------------|----------------------|
| 4.   | <b>Environmental tests</b>                        |                                                                                                                                                                                                                                                                                                                                                                                                                                       |                      |
| 4.1. | Operating temperature                             | Verify functionality (as defined in test No 3.3) in temperature range [- 40 °C; + 135 °C] through:<br>— IEC 68-2-1 test Ad, with a test duration of 96 hours at the lowest temperature $T_{\min}$<br>— IEC 68-2-2 test Bd, with a test duration of 96 hours at the highest temperature $T_{\max}$                                                                                                                                     | 159                  |
| 4.2. | Temperature cycles                                | Verify functionality (as defined in test No 3.3) through IEC 68-2-14 test Na, 20 cycles, each with temperature varying from the lower temperature (- 40 °C) to the higher temperature (+135 °C) and a 2 hours stay at both the lower and the higher temperature<br><br>A reduced set of tests (among those defined in test 3.3) can be carried out at the lower temperature, the higher temperature and during the temperature cycles | 159                  |
| 4.3. | Humidity cycles                                   | Verify functionality (as defined in test No 3.3) through IEC 68-2-30, test Db, six 24 hours cycles, each temperature varying from + 25 °C to + 55 °C and a relative humidity of 97 % at + 25 °C and equal to 93 % at + 55 °C                                                                                                                                                                                                          | 160                  |
| 4.4. | Vibration                                         | Verify functionality (as defined in test No 3.3) through IEC 68-2-6, test Fc, with a test duration of 100 frequency cycles:<br><br>constant displacement between 10 and 57 Hz: 1,5 mm peak<br>constant acceleration between 57 and 500 Hz: 20 g                                                                                                                                                                                       | 163                  |
| 4.5. | Mechanical shock                                  | Verify functionality (as defined in test No 3.3) through IEC 68-2-27, test Ea, 3 shocks in both directions of the 3 perpendicular axes                                                                                                                                                                                                                                                                                                | 163                  |
| 4.6. | Protection against water and foreign bodies       | Verify that the motion sensor protection index according to IEC 529 is at least IP 64, when mounted in operating conditions in a vehicle                                                                                                                                                                                                                                                                                              | 165                  |
| 4.7. | Reverse polarity protection                       | Verify that the motion sensor can withstand an inversion of its power supply                                                                                                                                                                                                                                                                                                                                                          | 161                  |
| 4.8. | Short circuit protection                          | Verify that input output signals are protected against short circuits to power supply and ground                                                                                                                                                                                                                                                                                                                                      | 161                  |
| 5.   | <b>EMC</b>                                        |                                                                                                                                                                                                                                                                                                                                                                                                                                       |                      |
| 5.1. | Radiated emissions and susceptibility             | Verify compliance with Directive 95/54/EEC                                                                                                                                                                                                                                                                                                                                                                                            | 162                  |
| 5.2. | Electrostatic discharge                           | Compliance with IEC 61000-4-2, $\pm 2$ kV (level 1)                                                                                                                                                                                                                                                                                                                                                                                   | 162                  |
| 5.3. | Conducted transient susceptibility on data lines) | Compliance with ISO 7637-3 (level III)                                                                                                                                                                                                                                                                                                                                                                                                | 162                  |

## 4. TACHOGRAPH CARDS FUNCTIONAL TESTS

| No   | Test                              | Description                                                                                                                                                                                                                                                                                              | Related requirements                                                                                                                        |
|------|-----------------------------------|----------------------------------------------------------------------------------------------------------------------------------------------------------------------------------------------------------------------------------------------------------------------------------------------------------|---------------------------------------------------------------------------------------------------------------------------------------------|
| 1.   | <b>Administrative examination</b> |                                                                                                                                                                                                                                                                                                          |                                                                                                                                             |
| 1.1. | Documentation                     | Correctness of documentation                                                                                                                                                                                                                                                                             |                                                                                                                                             |
| 2.   | <b>Visual inspection</b>          |                                                                                                                                                                                                                                                                                                          |                                                                                                                                             |
| 2.1. |                                   | Make sure that all features for protection and visible data are correctly printed on the card and compliant                                                                                                                                                                                              | 171 to 181                                                                                                                                  |
| 3.   | <b>Physical tests</b>             |                                                                                                                                                                                                                                                                                                          |                                                                                                                                             |
| 3.1. |                                   | Check dimension of the card and location of the contacts                                                                                                                                                                                                                                                 | 184<br>ISO/IEC 7816-1<br>ISO/IEC 7816-2                                                                                                     |
| 4.   | <b>Protocol tests</b>             |                                                                                                                                                                                                                                                                                                          |                                                                                                                                             |
| 4.1. | ATR                               | Check that the ATR is compliant                                                                                                                                                                                                                                                                          | ISO/IEC 7816-3<br>TCS 304, 307,<br>308                                                                                                      |
| 4.2. | T=0                               | Check that T=0 protocol is compliant                                                                                                                                                                                                                                                                     | ISO/IEC 7816-3<br>TCS 302, 303,<br>305                                                                                                      |
| 4.3. | PTS                               | Check that the PTS command is compliant by setting T=1 from T=0                                                                                                                                                                                                                                          | ISO/IEC 7816-3<br>TCS 309 to 311                                                                                                            |
| 4.4. | T=1                               | Check that T=1 protocol is compliant                                                                                                                                                                                                                                                                     | ISO/IEC 7816-3<br>TCS 303, / 306                                                                                                            |
| 5.   | <b>Card structure</b>             |                                                                                                                                                                                                                                                                                                          |                                                                                                                                             |
| 5.1. |                                   | Test that the file structure of the card is compliant by checking the presence of the mandatory files in the card and their access conditions                                                                                                                                                            | TCS 312<br>TCS 400*, 401,<br>402, 403*, 404,<br>405*, 406, 407,<br>408*, 409, 410*,<br>411, 412, 413*,<br>414, 415*, 416,<br>417, 418*, 419 |
| 6.   | <b>Functional tests</b>           |                                                                                                                                                                                                                                                                                                          |                                                                                                                                             |
| 6.1. | Normal processing                 | Test at least once each allowed usage of each command (ex: test the UPDATE BINARY command with CLA = '00', CLA = '0C' and with different P1, P2 and Lc parameters)<br><br>Check that the operations have actually been performed in the card (ex: by reading the file the command has been performed on) | TCS 313 to TCS<br>379                                                                                                                       |
| 6.2. | Error messages                    | Test at least once each error message (as specified in Appendix 2) for each command<br><br>Test at least once every generic error (except '6400' integrity errors checked during security certification)                                                                                                 |                                                                                                                                             |
| 7.   | <b>Environmental tests</b>        |                                                                                                                                                                                                                                                                                                          |                                                                                                                                             |
| 7.1. |                                   | Make sure that the cards work within the limit conditions defined in accordance with ISO/IEC 10373                                                                                                                                                                                                       | 185 to 188<br>ISO/IEC 7816-1                                                                                                                |

## 5. INTEROPERABILITY TESTS

| No | Test                  | Description                                                                                                                                                                                                                                                                                                                                                                       |
|----|-----------------------|-----------------------------------------------------------------------------------------------------------------------------------------------------------------------------------------------------------------------------------------------------------------------------------------------------------------------------------------------------------------------------------|
| 1. | Mutual authentication | Check that the mutual authentication between the vehicle unit and the tachograph card runs normally                                                                                                                                                                                                                                                                               |
| 2. | Write/read tests      | Execute a typical activity scenario on the vehicle unit. The scenario shall be adapted to the type of card being tested and involve writings in as many EFs as possible in the card<br>Verify through a card downloading that all corresponding recordings have been properly made<br>Verify through a card daily printout that all corresponding recordings can be properly read |

## Appendix 10

**GENERIC SECURITY TARGETS**

This appendix specifies the minimum required content of motion sensor, vehicle unit and tachograph card security targets.

In order to form the security targets against which they may seek security certification, manufacturers shall refine and complete the documents as necessary, without amending nor deleting existing threats, objectives, procedural means and security enforcing functions specifications.

## CONTENTS

**Motion sensor generic security target**

|        |                                                                     |     |
|--------|---------------------------------------------------------------------|-----|
| 1.     | Introduction .....                                                  | 204 |
| 2.     | Abbreviations, definitions and references .....                     | 204 |
| 2.1.   | Abbreviations .....                                                 | 204 |
| 2.2.   | Definitions .....                                                   | 204 |
| 2.3.   | References .....                                                    | 204 |
| 3.     | Product rationale .....                                             | 205 |
| 3.1.   | Motion sensor description and method of use .....                   | 205 |
| 3.2.   | Motion sensor life cycle .....                                      | 206 |
| 3.3.   | Threats .....                                                       | 206 |
| 3.3.1. | Threats to access control policies .....                            | 206 |
| 3.3.2. | Design related threats .....                                        | 207 |
| 3.3.3. | Operation oriented threats .....                                    | 207 |
| 3.4.   | Security objectives .....                                           | 207 |
| 3.5.   | Information technology security objectives .....                    | 207 |
| 3.6.   | Physical, personnel or procedural means .....                       | 208 |
| 3.6.1. | Equipment design .....                                              | 208 |
| 3.6.2. | Equipment delivery .....                                            | 208 |
| 3.6.3. | Security data generation and delivery .....                         | 208 |
| 3.6.4. | Recording equipment installation, calibration, and inspection ..... | 208 |
| 3.6.5. | Law enforcement control .....                                       | 208 |
| 3.6.6. | Software upgrades .....                                             | 208 |
| 4.     | Security enforcing functions .....                                  | 208 |
| 4.1.   | Identificacion and authentication .....                             | 208 |
| 4.2.   | Access control .....                                                | 209 |
| 4.2.1. | Access control policy .....                                         | 209 |
| 4.2.2. | Data access rights .....                                            | 209 |
| 4.2.3. | File structure and access conditions .....                          | 209 |
| 4.3.   | Accountability .....                                                | 209 |

|        |                                         |     |
|--------|-----------------------------------------|-----|
| 4.4.   | Audit                                   | 210 |
| 4.5.   | Accuracy                                | 210 |
| 4.5.1. | Information flow control policy         | 210 |
| 4.5.2. | Internal data transfers                 | 210 |
| 4.5.3. | Stored data integrity                   | 210 |
| 4.6.   | Reliability of service                  | 210 |
| 4.6.1. | Tests                                   | 210 |
| 4.6.2. | Software                                | 211 |
| 4.6.3. | Physical protection                     | 211 |
| 4.6.4. | Power supply interruptions              | 211 |
| 4.6.5. | Reset conditions                        | 211 |
| 4.6.6. | Data availability                       | 211 |
| 4.6.7. | Multiple applications                   | 211 |
| 4.7.   | Data exchange                           | 211 |
| 4.8.   | Cryptographic support                   | 211 |
| 5.     | Definition of security mechanisms       | 212 |
| 6.     | Minimum strength of security mechanisms | 212 |
| 7.     | Level of assurance                      | 212 |
| 8.     | Rationale                               | 212 |

#### **Vehicle Unit generic security target**

|        |                                                       |     |
|--------|-------------------------------------------------------|-----|
| 1.     | Introduction                                          | 214 |
| 2.     | Abbreviations, definitions and references             | 214 |
| 2.1.   | Abbreviations                                         | 214 |
| 2.2.   | Definitions                                           | 214 |
| 2.3.   | References                                            | 214 |
| 3.     | Product rationale                                     | 214 |
| 3.1.   | Vehicle unit description and method of use            | 214 |
| 3.2.   | Vehicle unit life cycle                               | 216 |
| 3.3.   | Threats                                               | 216 |
| 3.3.1. | Threats to identification and access control policies | 216 |
| 3.3.2. | Design related threats                                | 217 |
| 3.3.3. | Operation oriented threats                            | 217 |
| 3.4.   | Security objectives                                   | 217 |
| 3.5.   | Information technology security objectives            | 218 |
| 3.6.   | Physica, personnel or procedural means                | 218 |
| 3.6.1. | Equipment design                                      | 218 |
| 3.6.2. | Equipment delivery and activation                     | 218 |



|                                                                               |     |
|-------------------------------------------------------------------------------|-----|
| 3.6.3. Security data generation and delivery .....                            | 218 |
| 3.6.4. Cards delivery .....                                                   | 219 |
| 3.6.5. Recording equipment installation, calibration, and inspection .....    | 219 |
| 3.6.6. Equipment operation .....                                              | 219 |
| 3.6.7. Law enforcement control .....                                          | 219 |
| 3.6.8. Software upgrades .....                                                | 219 |
| 4. Security enforcing functions .....                                         | 219 |
| 4.1. Identification and authentication .....                                  | 219 |
| 4.1.1. Motion sensor identification and authentication .....                  | 219 |
| 4.1.2. User identification and authentication .....                           | 220 |
| 4.1.3. Remotely connected company identificatin and authentication .....      | 221 |
| 4.1.4. Management device identification and authentication .....              | 221 |
| 4.2. Access control .....                                                     | 221 |
| 4.2.1. Access control policy .....                                            | 221 |
| 4.2.2. Access rights to functions .....                                       | 221 |
| 4.2.3. Access rights to data .....                                            | 221 |
| 4.2.4. File structure and access conditions .....                             | 222 |
| 4.3. Accountability .....                                                     | 222 |
| 4.4. Audit .....                                                              | 222 |
| 4.5. Object re-use .....                                                      | 223 |
| 4.6. Accuracy .....                                                           | 223 |
| 4.6.1. Information flow control policy .....                                  | 223 |
| 4.6.2. Internal data transfers .....                                          | 223 |
| 4.6.3. Stored data integrity .....                                            | 223 |
| 4.7. Reliability of service .....                                             | 223 |
| 4.7.1. Tests .....                                                            | 223 |
| 4.7.2. Software .....                                                         | 224 |
| 4.7.3. Physical protection .....                                              | 224 |
| 4.7.4. Power supply interruptions .....                                       | 224 |
| 4.7.5. Reset conditions .....                                                 | 224 |
| 4.7.6. Data availability .....                                                | 224 |
| 4.7.7. Multiple applications .....                                            | 224 |
| 4.8. Data exchange .....                                                      | 224 |
| 4.8.1. Data exchange with motion sensor .....                                 | 224 |
| 4.8.2. Data exchange with tachograph cards .....                              | 225 |
| 4.8.3. Data exchange with external storage media (downloading function) ..... | 225 |
| 4.9. Cryptographic support .....                                              | 225 |

|    |                                         |     |
|----|-----------------------------------------|-----|
| 5. | Definition of security mechanisms       | 225 |
| 6. | Minimum strength of security mechanisms | 225 |
| 7. | Level of assurance                      | 225 |
| 8. | Rationale                               | 226 |

### **Tachograph card generic security target**

|        |                                               |     |
|--------|-----------------------------------------------|-----|
| 1.     | Introduction                                  | 230 |
| 2.     | Abbreviations, definitions and references     | 230 |
| 2.1.   | Abbreviations                                 | 230 |
| 2.2.   | Definitions                                   | 231 |
| 2.3.   | References                                    | 231 |
| 3.     | Product rationale                             | 231 |
| 3.1.   | Tachograph card description and method of use | 231 |
| 3.2.   | Tachograph card life-cycle                    | 231 |
| 3.3.   | Threats                                       | 232 |
| 3.3.1. | Final aims                                    | 232 |
| 3.3.2. | Attack paths                                  | 232 |
| 3.4.   | Security objectives                           | 232 |
| 3.5.   | Information technology security objectives    | 232 |
| 3.6.   | Physical, personnel or procedural means       | 232 |
| 4.     | Security enforcing functions                  | 233 |
| 4.1.   | Compliance to protection profiles             | 233 |
| 4.2.   | User identification and authentication        | 233 |
| 4.2.1. | User identification                           | 233 |
| 4.2.2. | User authentication                           | 233 |
| 4.2.3. | Authentication failures                       | 233 |
| 4.3.   | Access control                                | 234 |
| 4.3.1. | Access control policy                         | 234 |
| 4.3.2. | Access control functions                      | 234 |
| 4.4.   | Accountability                                | 234 |
| 4.5.   | Audit                                         | 234 |
| 4.6.   | Accuracy                                      | 234 |
| 4.6.1. | Stored data integrity                         | 234 |
| 4.6.2. | Basic data authentication                     | 234 |
| 4.7.   | Reliability of service                        | 235 |
| 4.7.1. | Tests                                         | 235 |
| 4.7.2. | Software                                      | 235 |
| 4.7.3. | Power supply                                  | 235 |

---

|                                                                       |     |
|-----------------------------------------------------------------------|-----|
| 4.7.4. Reset conditions .....                                         | 235 |
| 4.8. Data exchange .....                                              | 235 |
| 4.8.1. Data exchange with a vehicle unit .....                        | 235 |
| 4.8.2. Export of data to a non-vehicle unit (download function) ..... | 235 |
| 4.9. Cryptographic support .....                                      | 235 |
| 5. Definition of security mechanisms .....                            | 235 |
| 6. Claimed minimum strength of mechanisms .....                       | 236 |
| 7. Level of assurance .....                                           | 236 |
| 8. Rationale .....                                                    | 236 |

## MOTION SENSOR GENERIC SECURITY TARGET

**1. Introduction**

This document contains a description of the motion sensor, of the threats it must be able to counteract and of the security objectives it must achieve. It specifies the required security enforcing functions. It states the claimed minimum strength of security mechanisms and the required level of assurance for the development and the evaluation.

Requirements referred to in the document, are those of the body of Annex I B. For clarity of reading, duplication sometimes arises between Annex I B body requirements and security target requirements. In case of ambiguity between a security target requirement and the Annex I B body requirement referred by this security target requirement, the Annex I B body requirement shall prevail.

Annex I B body requirements not referred by security targets are not the subject of security enforcing functions.

Unique labels have been assigned to threats, objectives, procedural means and SEF specifications for the purpose of traceability to development and evaluation documentation.

**2. Abbreviations, definitions and references****2.1. Abbreviations**

ROM Read only Memory

SEF Security enforcing function

TBD To be defined

TOE Target of evaluation

VU Vehicle unit.

**2.2. Definitions**

|                            |                                                                                                                                                       |
|----------------------------|-------------------------------------------------------------------------------------------------------------------------------------------------------|
| Digital Tachograph         | Recording equipment                                                                                                                                   |
| Entity                     | A device connected to the motion sensor                                                                                                               |
| Motion data                | The data exchanged with the VU, representative of speed and distance travelled                                                                        |
| Physically separated parts | Physical components of the motion sensor that are distributed in the vehicle as opposed to physical components gathered into the motion sensor casing |
| Security data              | The specific data needed to support security enforcing functions (e.g. crypto keys)                                                                   |
| System                     | Equipment, people or organisations, involved in any way with the recording equipment                                                                  |
| User                       | A human user of the motion sensor (when not used in the expression "user data")                                                                       |
| User data                  | Any data, other than motion or security data, recorded or stored by the motion sensor.                                                                |

### 2.3. References

ITSEC ITSEC Information Technology Security Evaluation Criteria 1991.

## 3. Product rationale

### 3.1. Motion sensor description and method of use

The motion sensor is intended to be installed in road transport vehicles. Its purpose is to provide a VU with secured motion data representative of vehicle's speed and distance travelled.

The motion sensor is mechanically interfaced to a moving part of the vehicle, which movement can be representative of vehicle's speed or distance travelled. It may be located in the vehicle's gear box or in any other part of the vehicle.

In its operational mode, the motion sensor is connected to a VU.

It may also be connected to specific equipment for management purposes (TBD by manufacturer).

The typical motion sensor is described in the following figure:

Figure 1

#### Typical motion sensor

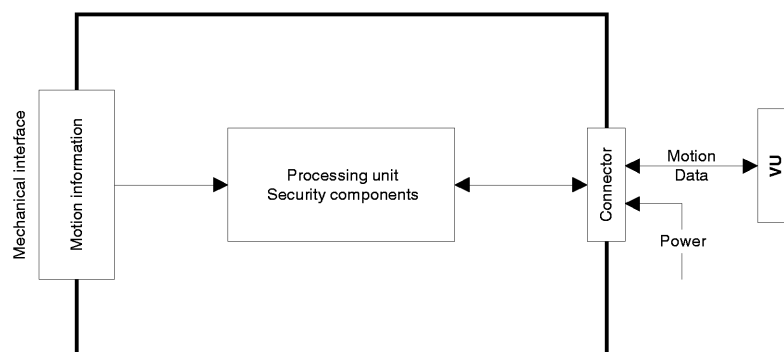

3.2. **Motion sensor life cycle**

The typical life cycle of the motion sensor is described in the following figure:

Figure 2

**Motion sensor typical life cycle**

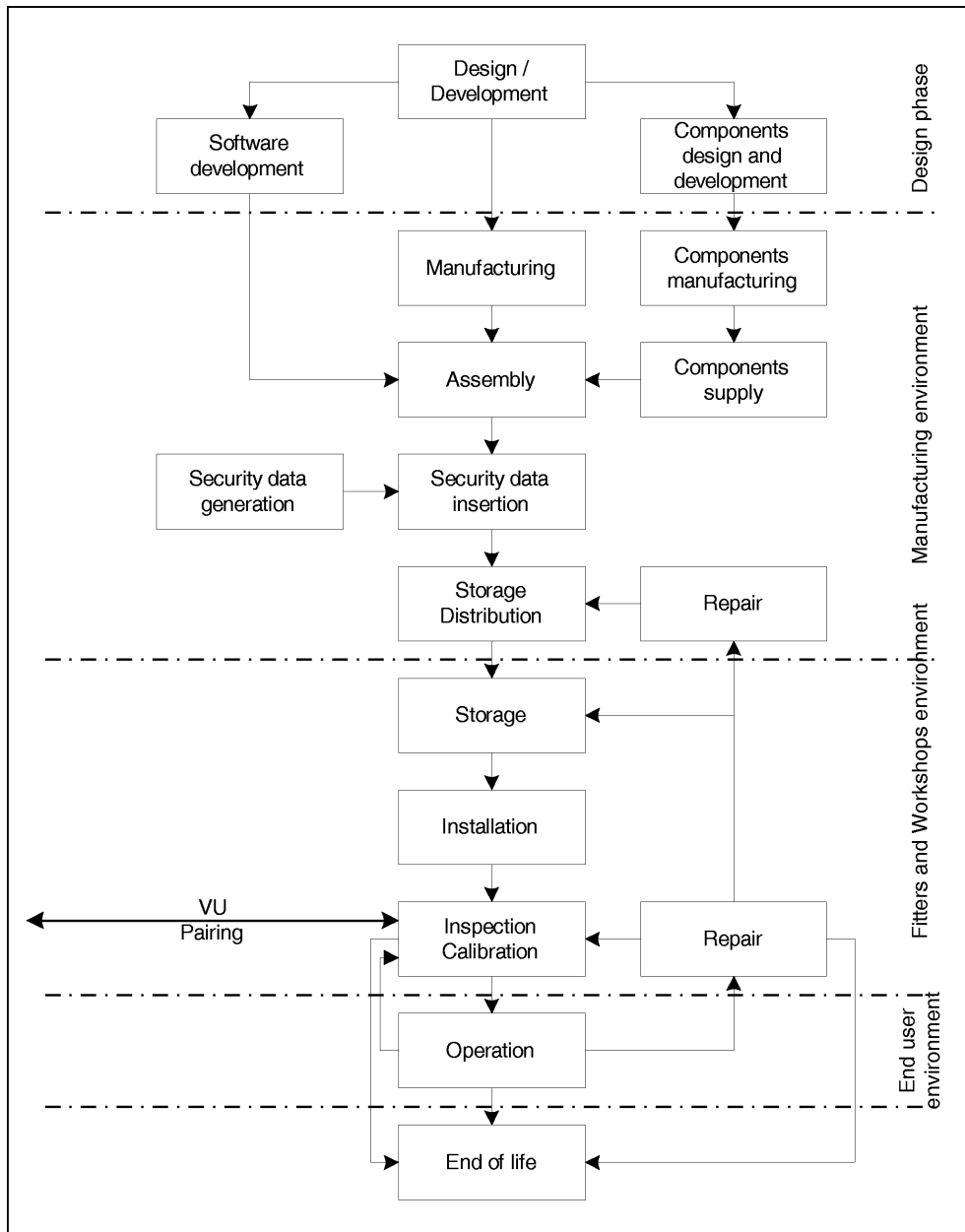

3.3. **Threats**

This paragraph describes the threats the motion sensor may face.

3.3.1. *Threats to access control policies*

T.Access

Users could try to access functions not allowed to them.

### 3.3.2. Design related threats

|          |                                                                                                                                                    |
|----------|----------------------------------------------------------------------------------------------------------------------------------------------------|
| T.Faults | Faults in hardware, software, communication procedures could place the motion sensor in unforeseen conditions compromising its security            |
| T.Tests  | The use of non invalidated test modes or of existing back doors could compromise the motion sensor security                                        |
| T.Design | Users could try to gain illicit knowledge of design either from manufacturer's material (through theft, bribery, ...) or from reverse engineering. |

### 3.3.3. Operation oriented threats

|                     |                                                                                                                                                |
|---------------------|------------------------------------------------------------------------------------------------------------------------------------------------|
| T.Environment       | Users could compromise the motion sensor security through environmental attacks (thermal, electromagnetic, optical, chemical, mechanical, ...) |
| T.Hardware          | Users could try to modify motion sensor hardware                                                                                               |
| T.Mechanical_Origin | Users could try to manipulate the motion sensor input (e.g. unscrewing from gearbox, ...)                                                      |
| T.Motion_Data       | Users could try to modify the vehicle's motion data (addition, modification, deletion, replay of signal)                                       |
| T.Power_Supply      | Users could try to defeat the motion sensor security objectives by modifying (cutting, reducing, increasing) its power supply                  |
| T.Security_Data     | Users could try to gain illicit knowledge of security data during security data generation or transport or storage in the equipment            |
| T.Software          | Users could try to modify motion sensor software                                                                                               |
| T.Stored_Data       | Users could try to modify stored data (security or user data).                                                                                 |

### 3.4. Security objectives

The main security objective of the digital tachograph system is the following:

|        |                                                                                                                                                                                                                                           |
|--------|-------------------------------------------------------------------------------------------------------------------------------------------------------------------------------------------------------------------------------------------|
| O.Main | The data to be checked by control authorities must be available and reflect fully and accurately the activities of controlled drivers and vehicles in terms of driving, work, availability and rest periods and in terms of vehicle speed |
|--------|-------------------------------------------------------------------------------------------------------------------------------------------------------------------------------------------------------------------------------------------|

Therefore the security objective of the motion sensor, contributing to the global security objective, is:

|               |                                                                                                                                                                                                     |
|---------------|-----------------------------------------------------------------------------------------------------------------------------------------------------------------------------------------------------|
| O.Sensor_Main | The data transmitted by the motion sensor must be available to the VU so as to allow the VU to determine fully and accurately the movement of the vehicle in terms of speed and distance travelled. |
|---------------|-----------------------------------------------------------------------------------------------------------------------------------------------------------------------------------------------------|

### 3.5. Information technology security objectives

The specific IT security objectives of the motion sensor contributing to its main security objective, are the following:

|                  |                                                                                                              |
|------------------|--------------------------------------------------------------------------------------------------------------|
| O.Access         | The motion sensor must control connected entities' access to functions and data                              |
| O.Audit          | The motion sensor must audit attempts to undermine its security and should trace them to associated entities |
| O.Authentication | The motion sensor must authenticate connected entities                                                       |

|                         |                                                                                          |
|-------------------------|------------------------------------------------------------------------------------------|
| O.Processing            | The motion sensor must ensure that processing of input to derive motion data is accurate |
| O.Reliability           | The motion sensor must provide a reliable service                                        |
| O.Secured_Data_Exchange | The motion sensor must secure data exchanges with the VU.                                |

### 3.6. **Physical, personnel or procedural means**

This paragraph describes physical, personnel or procedural requirements that contribute to the security of the motion sensor.

#### 3.6.1. *Equipment design*

|                 |                                                                                                                                                                                                                                                                                          |
|-----------------|------------------------------------------------------------------------------------------------------------------------------------------------------------------------------------------------------------------------------------------------------------------------------------------|
| M.Development   | Motion sensor developers must ensure that the assignment of responsibilities during development is done in a manner which maintains IT security                                                                                                                                          |
| M.Manufacturing | Motion sensor manufacturers must ensure that the assignment of responsibilities during manufacturing is done in a manner which maintains IT security, and that during the manufacturing process the motion sensor is protected from physical attacks which might compromise IT security. |

#### 3.6.2. *Equipment delivery*

|            |                                                                                                                                                                             |
|------------|-----------------------------------------------------------------------------------------------------------------------------------------------------------------------------|
| M.Delivery | Motion sensor manufacturers, vehicle manufacturers and fitters or workshops must ensure that handling of the motion sensor is done in a manner which maintains IT security. |
|------------|-----------------------------------------------------------------------------------------------------------------------------------------------------------------------------|

#### 3.6.3. *Security data generation and delivery*

|                       |                                                                                                                                                             |
|-----------------------|-------------------------------------------------------------------------------------------------------------------------------------------------------------|
| M.Sec_Data_Generation | Security data generation algorithms must be accessible to authorised and trusted persons only                                                               |
| M.Sec_Data_Transport  | Security data must be generated, transported, and inserted into the motion sensor, in such a way to preserve its appropriate confidentiality and integrity. |

#### 3.6.4. *Recording equipment installation, calibration, and inspection*

|                        |                                                                                                                          |
|------------------------|--------------------------------------------------------------------------------------------------------------------------|
| M.Approved_Workshops   | Installation, calibration and repair of recording equipment must be carried by trusted and approved fitters or workshops |
| M.Mechanical_Interface | Means of detecting physical tampering with the mechanical interface must be provided (e.g. seals)                        |
| M.Regular_Inspections  | Recording equipment must be periodically inspected and calibrated.                                                       |

#### 3.6.5. *Law enforcement control*

|            |                                                                                                      |
|------------|------------------------------------------------------------------------------------------------------|
| M.Controls | Law enforcement controls must be performed regularly and randomly, and must include security audits. |
|------------|------------------------------------------------------------------------------------------------------|

#### 3.6.6. *Software upgrades*

|                    |                                                                                                              |
|--------------------|--------------------------------------------------------------------------------------------------------------|
| M.Software_Upgrade | Software revisions must be granted security certification before they can be implemented in a motion sensor. |
|--------------------|--------------------------------------------------------------------------------------------------------------|

## 4. **Security enforcing functions**

### 4.1. **Identification and authentication**

UIA\_101 The motion sensor shall be able to establish, for every interaction, the identity of any entity it is connected to.



UIA\_102 The identity of a connected entity shall consist of:

- an entity group:
  - VU,
  - Management device,
  - Other,
- an entity ID (VU only).

UIA\_103 The entity ID of a connected VU shall consist of the VU approval number and the VU serial number.

UIA\_104 The motion sensor shall be able to authenticate any VU or management device it is connected to:

- at entity connection,
- at power supply recovery.

UIA\_105 The motion sensor shall be able to periodically re-authenticate the VU it is connected to.

UIA\_106 The motion sensor shall detect and prevent use of authentication data that has been copied and replayed.

UIA\_107 After (TBD by manufacturer and not more than 20) consecutive unsuccessful authentication attempts have been detected, the SEF shall:

- generate an audit record of the event,
- warn the entity,
- continue to export motion data in a non secured mode.

#### 4.2. **Access control**

Access controls ensure that information is read from, created in, or modified into the TOE only by those authorised to do so.

##### 4.2.1. *Access control policy*

ACC\_101 The motion sensor shall control access rights to function and data.

##### 4.2.2. *Data access rights*

ACC\_102 The motion sensor shall ensure that motion sensor identification data can be written once only (requirement 078).

ACC\_103 The motion sensor shall accept and/or store user data from authenticated entities only.

ACC\_104 The motion sensor shall enforce appropriate read and write access rights to security data.

##### 4.2.3. *File structure and access conditions*

ACC\_105 Application and data files structure and access conditions shall be created during the manufacturing process, and then locked from any future modification or deletion.

#### 4.3. **Accountability**

ACT\_101 The motion sensor shall hold in its memory motion sensor identification data (requirement 077).

ACT\_102 The motion sensor shall store in its memory installation data (requirement 099).

ACT\_103 The motion sensor shall have a capability to output accountability data to authenticated entities at their request.

#### 4.4. **Audit**

AUD\_101 The motion sensor shall, for events impairing its security, generate audit records of the events.

AUD\_102 The events affecting the security of the motion sensor are the following:

- security breach attempts,
  - authentication failure,
  - stored data integrity error,
  - internal data transfer error,
  - unauthorised case opening,
  - hardware sabotage.
- sensor fault.

AUD\_103 Audit records shall include the following data:

- date and time of the event,
- type of event,
- connected entity identity.

when required data is not available, an appropriate default indication shall be given (TBD by manufacturer).

AUD\_104 The motion sensor shall send the generated audit records to the VU at the moment of their generation, and may also store them in its memory.

AUD\_105 In the case where the motion sensor stores audit records, it shall ensure that 20 audit records will be maintained independent of audit storage exhaustion, and shall have a capability to output stored audit records to authenticated entities at their request.

#### 4.5. **Accuracy**

##### 4.5.1. *Information flow control policy*

ACR\_101 The motion sensor shall ensure that motion data may only be processed and derived from sensor mechanical input.

##### 4.5.2. *Internal data transfers*

The requirements of this paragraph apply only if the motion sensor makes use of physically separated parts.

ACR\_102 If data are transferred between physically separated parts of the motion sensor, the data shall be protected from modification.

ACR\_103 Upon detection of a data transfer error during an internal transfer, transmission shall be repeated and the SEF shall generate an audit record of the event.

##### 4.5.3. *Stored data integrity*

ACR\_104 The motion sensor shall check user data stored in its memory for integrity errors.

ACR\_105 Upon detection of a stored user data integrity error, the SEF shall generate an audit record.

#### 4.6. **Reliability of service**

##### 4.6.1 *Tests*

RLB\_101 All commands, actions, or test points, specific to the testing needs of the manufacturing phase shall be disabled or removed before the end of the manufacturing phase. It shall not be possible to restore them for later use.

RLB\_102 The motion sensor shall run self-tests, during initial start-up, and during normal operation to verify its correct operation. The motion sensor self-tests shall include a verification of the integrity of security data and a verification of the integrity of stored executable code (if not in ROM).

RLB\_103 Upon detection of an internal fault during self-test, the SEF shall generate an audit record (sensor fault).

#### 4.6.2. Software

RLB\_104 There shall be no way to analyse or debug the motion sensor software in the field.

RLB\_105 Inputs from external sources shall not be accepted as executable code.

#### 4.6.3. Physical protection

RLB\_106 If the motion sensor is designed so that it can be opened, the motion sensor shall detect any case opening, even without external power supply for a minimum of 6 months. In such a case, the SEF shall generate an audit record of the event (It is acceptable that the audit record is generated and stored after power supply reconnection).

If the motion sensor is designed so that it cannot be opened, it shall be designed such that physical tampering attempts can be easily detected (e.g. through visual inspection).

RLB\_107 The motion sensor shall detect specified (TBD by manufacturer) hardware sabotage.

RLB\_108 In the case described above, the SEF shall generate an audit record and the motion sensor shall: (TBD by manufacturer).

#### 4.6.4. Power supply interruptions

RLB\_109 The motion sensor shall preserve a secure state during power supply cut-off or variations.

#### 4.6.5. Reset conditions

RLB\_110 In case of a power supply interruption, or if a transaction is stopped before completion, or on any other reset conditions, the motion sensor shall be reset cleanly.

#### 4.6.6. Data availability

RLB\_111 The motion sensor shall ensure that access to resources is obtained when required and that resources are not requested nor retained unnecessarily.

#### 4.6.7. Multiple applications

RLB\_112 If the motion sensor provides applications other than the tachograph application, all applications shall be physically and/or logically separated from each other. These applications shall not share security data. Only one task shall be active at a time.

### 4.7. Data exchange

DEX\_101 The motion sensor shall export motion data to the VU with associated security attributes, such that the VU will be able to verify its integrity and authenticity.

### 4.8. Cryptographic support

The requirements of this paragraph are applicable only where needed, depending upon security mechanisms used and upon the manufacturer's solutions.

CSP\_101 Any cryptographic operation performed by the motion sensor shall be in accordance with a specified algorithm and a specified key size.

CSP\_102 If the motion sensor generates cryptographic keys, it shall be in accordance with specified cryptographic key generation algorithms and specified cryptographic key sizes.

CSP\_103 If the motion sensor distributes cryptographic keys, it shall be in accordance with specified key distribution methods.

CSP\_104 If the motion sensor accesses cryptographic keys, it shall be in accordance with specified cryptographic keys access methods.

CSP\_105 If the motion sensor destroys cryptographic keys, it shall be in accordance with specified cryptographic keys destruction methods.

## 5. Definition of security mechanisms

The security mechanisms, fulfilling the motion sensor security enforcing functions, are defined by the motion sensor manufacturers.

## 6. Minimum strength of security mechanisms

The minimum strength of the motion sensor security mechanisms is High, as defined in (ITSEC).

## 7. Level of assurance

The target level of assurance for the motion sensor is ITSEC level E3, as defined in (ITSEC).

## 8. Rationale

The following matrixes give a rationale for the SEFs by showing:

- which SEFs or means counteract which threats,
- which SEFs fulfil which IT security objectives.

|                                     | Threats |        |       |        |             |          |                   |             |              |               |          | IT Objectives |        |       |                |            |             |                       |
|-------------------------------------|---------|--------|-------|--------|-------------|----------|-------------------|-------------|--------------|---------------|----------|---------------|--------|-------|----------------|------------|-------------|-----------------------|
|                                     | Access  | Faults | Tests | Design | Environment | Hardware | Mechanical_Origin | Motion_Data | Power_Supply | Security_Data | Software | Stored_Data   | Access | Audit | Authentication | Processing | Reliability | Secured_Data_Exchange |
| Physical Personnel Procedural means |         |        |       |        |             |          |                   |             |              |               |          |               |        |       |                |            |             |                       |
| Development                         |         | x      | x     | x      |             |          |                   |             |              |               |          |               |        |       |                |            |             |                       |
| Manufacturing                       |         |        | x     | x      |             |          |                   |             |              |               |          |               |        |       |                |            |             |                       |
| Delivery                            |         |        |       |        |             | x        |                   |             |              | x             | x        |               |        |       |                |            |             |                       |
| Security Data Generation            |         |        |       |        |             |          |                   |             | x            |               |          |               |        |       |                |            |             |                       |
| Security Data Transport             |         |        |       |        |             |          |                   |             | x            |               |          |               |        |       |                |            |             |                       |
| Approved Workshops                  |         |        |       |        |             |          | x                 |             |              |               |          |               |        |       |                |            |             |                       |
| Mechanical interface                |         |        |       |        |             |          | x                 |             |              |               |          |               |        |       |                |            |             |                       |
| Regular Inspection                  |         |        |       |        |             | x        | x                 | x           |              | x             |          |               |        |       |                |            |             |                       |
| Law enforcement controls            |         |        |       |        | x           | x        | x                 | x           | x            | x             |          |               |        |       |                |            |             |                       |
| Software Upgrades                   |         |        |       |        |             |          |                   |             |              | x             |          |               |        |       |                |            |             |                       |
| Security Enforcing Functions        |         |        |       |        |             |          |                   |             |              |               |          |               |        |       |                |            |             |                       |
| Identification and authentication   |         |        |       |        |             |          |                   |             |              |               |          |               |        |       |                |            |             |                       |
| UIA_101 Entities identification     | x       |        |       |        |             |          |                   | x           |              |               |          |               | x      |       | x              |            |             | x                     |
| UIA_102 Entities identity           | x       |        |       |        |             |          |                   |             |              |               |          |               | x      |       | x              |            |             |                       |
| UIA_103 VU identity                 |         |        |       |        |             |          |                   |             |              |               |          |               |        | x     |                |            |             |                       |
| UIA_104 Entities authentication     | x       |        |       |        |             |          |                   | x           |              |               |          |               | x      |       | x              |            |             | x                     |
| UIA_105 re-authentication           | x       |        |       |        |             |          |                   | x           |              |               |          |               | x      |       | x              |            |             | x                     |
| UIA_106 Unforgeable authentication  | x       |        |       |        |             |          |                   | x           |              |               |          |               | x      |       | x              |            |             |                       |
| UIA_107 Authentication failure      |         |        |       |        |             |          |                   | x           |              |               |          |               |        | x     |                |            | x           |                       |
| Access control                      |         |        |       |        |             |          |                   |             |              |               |          |               |        |       |                |            |             |                       |
| ACC_101 Access control policy       | x       |        |       |        |             |          |                   |             |              | x             |          | x             | x      |       |                |            |             |                       |
| ACC_102 Motion sensor ID            |         |        |       |        |             |          |                   |             |              |               |          | x             | x      |       |                |            |             |                       |



## VEHICLE UNIT GENERIC SECURITY TARGET

**1. Introduction**

This document contains a description of the vehicle unit, of the threats it must be able to counteract and of the security objectives it must achieve. It specifies the required security enforcing functions. It states the claimed minimum strength of security mechanisms and the required level of assurance for the development and the evaluation.

Requirements referred to in the document, are those of the body of Annex I B. For clarity of reading, duplication sometimes arises between Annex I B body requirements and security target requirements. In case of ambiguity between a security target requirement and the Annex I B body requirement referred by this security target requirement, the Annex I B body requirement shall prevail.

Annex I B body requirements not referred by security targets are not the subject of security enforcing functions.

Unique labels have been assigned to threats, objectives, procedural means and SEF specifications for the purpose of traceability to development and evaluation documentation.

**2. Abbreviations, definitions and references****2.1. Abbreviations**

|     |                                |
|-----|--------------------------------|
| PIN | Personal identification number |
| ROM | Read only memory               |
| SEF | Security enforcing function    |
| TBD | To be defined                  |
| TOE | Target of evaluation           |
| VU  | Vehicle Unit.                  |

**2.2. Definitions**

|                            |                                                                                                                                          |
|----------------------------|------------------------------------------------------------------------------------------------------------------------------------------|
| Digital tachograph         | Recording equipment                                                                                                                      |
| Motion data                | The data exchanged with the motion sensor, representative of speed and distance travelled                                                |
| Physically separated parts | Physical components of the VU that are distributed in the vehicle as opposed to physical components gathered into the VU casing          |
| Security data              | The specific data needed to support security enforcing functions (e.g. crypto keys)                                                      |
| System                     | Equipment, people or organisations, involved in any way with the recording equipment                                                     |
| User                       | Users are to be understood as human user of the equipment. Normal users of the VU comprise drivers, controllers, workshops and companies |
| User data                  | Any data, other than security data, recorded or stored by the VU, required by Chapter III.12.                                            |

**2.3. References**

ITSEC ITSEC Information Technology Security Evaluation Criteria 1991.

**3. Product rationale****3.1. Vehicle unit description and method of use**

The VU is intended to be installed in road transport vehicles. Its purpose is to record, store, display, print and output data related to driver activities.

It is connected to a motion sensor with which it exchanges vehicle's motion data.

Users identify themselves to the VU using tachograph cards.

The VU records and stores user activities data in its data memory, it also records user activities data in tachograph cards.

The VU outputs data to display, printer and external devices.

The vehicle unit's operational environment while installed in a vehicle is described in the following figure:

Figure 1

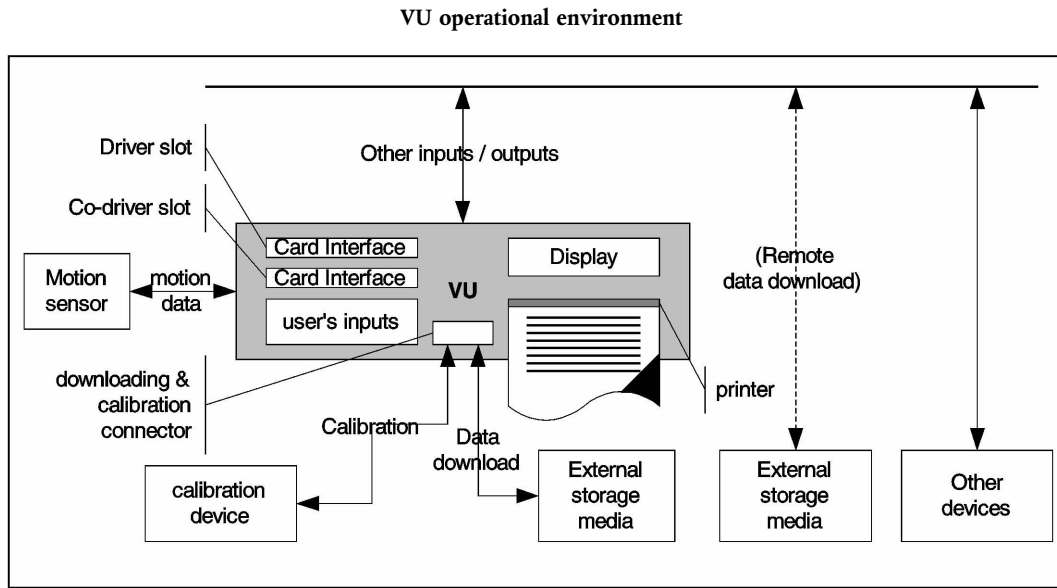

The VU general characteristics, functions and mode of operations are described in Chapter II of Annex I B.

The VU functional requirements are specified in Chapter III of Annex I B.

The typical VU is described in the following figure:

Figure 2

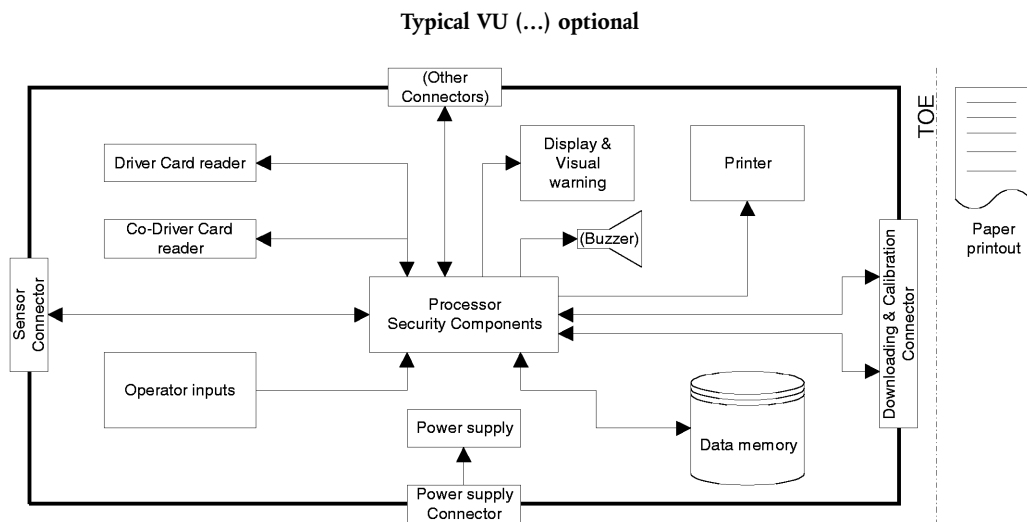

It must be noted that although the printer mechanism is part of the TOE, the paper document once produced is not.

3.2. **Vehicle unit life cycle**

The typical life cycle of the VU is described in the following figure:

Figure 3

**VU typical life cycle**

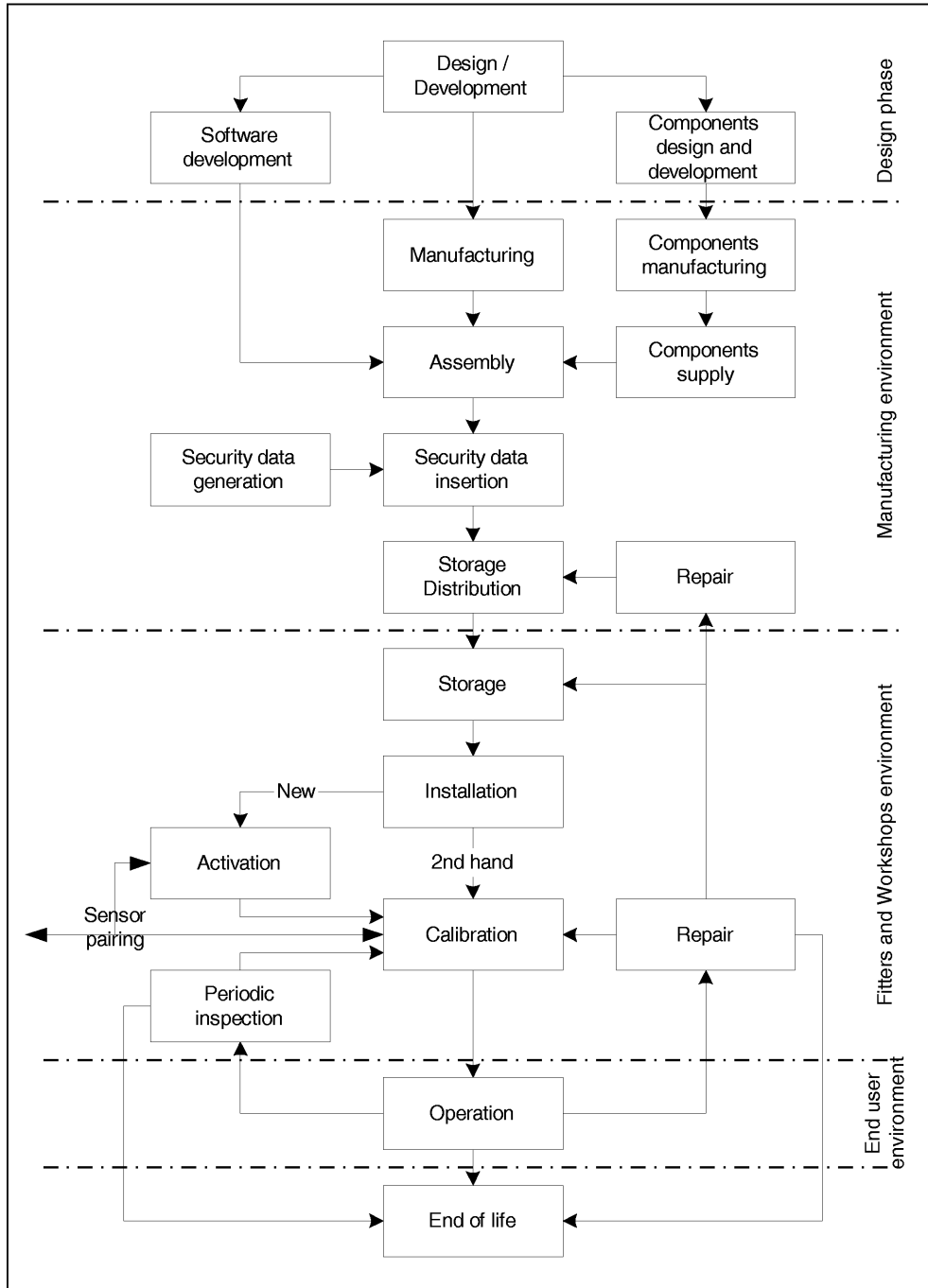

3.3. **Threats**

This paragraph describes the threats the VU may face.

3.3.1. *Threats to identification and access control policies*

T.Access

Users could try to access functions not allowed to them (e.g. drivers gaining access to calibration function)

T.Identification

Users could try to use several identifications or no identification.



### 3.3.2. *Design related threats*

|          |                                                                                                                                                   |
|----------|---------------------------------------------------------------------------------------------------------------------------------------------------|
| T.Faults | Faults in hardware, software, communication procedures could place the VU in unforeseen conditions compromising its security                      |
| T.Tests  | The use of non invalidated test modes or of existing back doors could compromise the VU security                                                  |
| T.Design | Users could try to gain illicit knowledge of design either from manufacturer's material (through theft, bribery, ...) or from reverse engineering |

### 3.3.3. *Operation oriented threats*

|                          |                                                                                                                                     |
|--------------------------|-------------------------------------------------------------------------------------------------------------------------------------|
| T.Calibration_Parameters | Users could try to use mis-calibrated equipment (through calibration data modification, or through organisational weaknesses)       |
| T.Card_Data_Exchange     | Users could try to modify data while exchanged between VU and tachograph cards (addition, modification, deletion, replay of signal) |
| T.Clock                  | Users could try to modify internal clock                                                                                            |
| T.Environment            | Users could compromise the VU security through environmental attacks (thermal, electromagnetic, optical, chemical, mechanical, ...) |
| T.Fake_Devices           | Users could try to connect fake devices (motion sensor, smart cards) to the VU                                                      |
| T.Hardware               | Users could try to modify VU hardware                                                                                               |
| T.Motion_Data            | Users could try to modify the vehicle's motion data (addition, modification, deletion, replay of signal)                            |
| T.Non_Activated          | Users could use non activated equipment                                                                                             |
| T.Output_Data            | Users could try to modify data output (print, display or download)                                                                  |
| T.Power_Supply           | Users could try to defeat the VU security objectives by modifying (cutting, reducing, increasing) its power supply                  |
| T.Security_Data          | Users could try to gain illicit knowledge of security data during security data generation or transport or storage in the equipment |
| T.Software               | Users could try to modify VU software                                                                                               |
| T.Stored_Data            | Users could try to modify stored data (security or user data).                                                                      |

### 3.4. **Security objectives**

The main security objective of the digital tachograph system is the following:

|        |                                                                                                                                                                                                                                           |
|--------|-------------------------------------------------------------------------------------------------------------------------------------------------------------------------------------------------------------------------------------------|
| O.Main | The data to be checked by control authorities must be available and reflect fully and accurately the activities of controlled drivers and vehicles in terms of driving, work, availability and rest periods and in terms of vehicle speed |
|--------|-------------------------------------------------------------------------------------------------------------------------------------------------------------------------------------------------------------------------------------------|

Therefore the security objectives of the VU, contributing to the global security objective, are the following:

|             |                                                                                                                                                                                                                                                                      |
|-------------|----------------------------------------------------------------------------------------------------------------------------------------------------------------------------------------------------------------------------------------------------------------------|
| O.VU_Main   | The data to be measured and recorded and then to be checked by control authorities must be available and reflect accurately the activities of controlled drivers and vehicles in terms of driving, work, availability and rest periods and in terms of vehicle speed |
| O.VU_Export | The VU must be able to export data to external storage media in such a way as to allow for verification of their integrity and authenticity.                                                                                                                         |

### 3.5. *Information technology security objectives*

The specific IT security objectives of the VU contributing to its main security objectives, are the following:

|                         |                                                                                                                        |
|-------------------------|------------------------------------------------------------------------------------------------------------------------|
| O.Access                | The VU must control user access to functions and data                                                                  |
| O.Accountability        | The VU must collect accurate accountability data                                                                       |
| O.Audit                 | The VU must audit attempts to undermine system security and should trace them to associated users                      |
| O.Authentication        | The VU should authenticate users and connected entities (when a trusted path needs to be established between entities) |
| O.Integrity             | The VU must maintain stored data integrity                                                                             |
| O.Output                | The VU must ensure that data output reflects accurately data measured or stored                                        |
| O.Processing            | The VU must ensure that processing of inputs to derive user data is accurate                                           |
| O.Reliability           | The VU must provide a reliable service                                                                                 |
| O.Secured_Data_Exchange | The VU must secure data exchanges with the motion sensor and with tachograph cards.                                    |

### 3.6. *Physical, personnel or procedural means*

This paragraph describes physical, personnel or procedural requirements that contribute to the security of the VU.

#### 3.6.1. *Equipment design*

|                 |                                                                                                                                                                                                                                                                    |
|-----------------|--------------------------------------------------------------------------------------------------------------------------------------------------------------------------------------------------------------------------------------------------------------------|
| M.Development   | VU developers must ensure that the assignment of responsibilities during development is done in a manner which maintains IT security                                                                                                                               |
| M.Manufacturing | VU manufacturers must ensure that the assignment of responsibilities during manufacturing is done in a manner which maintains IT security, and that during the manufacturing process the VU is protected from physical attacks which might compromise IT security. |

#### 3.6.2. *Equipment delivery and activation*

|              |                                                                                                                                                                  |
|--------------|------------------------------------------------------------------------------------------------------------------------------------------------------------------|
| M.Delivery   | VU manufacturers, vehicle manufacturers and fitters or workshops must ensure that handling of non activated VUs is done in a manner which maintains VU security  |
| M.Activation | Vehicle manufacturers and fitters or workshops must activate the VU after its installation before the vehicle leaves the premises where installation took place. |

#### 3.6.3. *Security data generation and delivery*

|                       |                                                                                                                                                  |
|-----------------------|--------------------------------------------------------------------------------------------------------------------------------------------------|
| M.Sec_Data_Generation | Security data generation algorithms must be accessible to authorised and trusted persons only                                                    |
| M.Sec_Data_Transport  | Security data must be generated, transported, and inserted into the VU, in such a way to preserve its appropriate confidentiality and integrity. |

### 3.6.4. Cards delivery

|                          |                                                                                                                  |
|--------------------------|------------------------------------------------------------------------------------------------------------------|
| M.Card_Availability      | Tachograph cards must be available and delivered to authorised persons only                                      |
| M.Driver_Card_Uniqueness | Drivers must possess, at one time, <b>one</b> valid driver card only                                             |
| M.Card_Traceability      | Card delivery must be traceable (white lists, black lists), and black lists must be used during security audits. |

### 3.6.5. Recording equipment installation, calibration, and inspection

|                        |                                                                                                                          |
|------------------------|--------------------------------------------------------------------------------------------------------------------------|
| M.Approved_Workshops   | Installation, calibration and repair of recording equipment must be carried by trusted and approved fitters or workshops |
| M.Regular_Inspections  | Recording equipment must be periodically inspected and calibrated                                                        |
| M.Faithful_Calibration | Approved fitters and workshops must enter proper vehicle parameters in recording equipment during calibration.           |

### 3.6.6. Equipment operation

|                    |                                                                                                                                                             |
|--------------------|-------------------------------------------------------------------------------------------------------------------------------------------------------------|
| M.Faithful_Drivers | Drivers must play by the rules and act responsibly (e.g. use their driver cards, properly select their activity for those that are manually selected, ...). |
|--------------------|-------------------------------------------------------------------------------------------------------------------------------------------------------------|

### 3.6.7. Law enforcement control

|            |                                                                                                      |
|------------|------------------------------------------------------------------------------------------------------|
| M.Controls | Law enforcement controls must be performed regularly and randomly, and must include security audits. |
|------------|------------------------------------------------------------------------------------------------------|

### 3.6.8. Software upgrades

|                    |                                                                                                   |
|--------------------|---------------------------------------------------------------------------------------------------|
| M.Software_Upgrade | Software revisions must be granted security certification before they can be implemented in a VU. |
|--------------------|---------------------------------------------------------------------------------------------------|

## 4. Security enforcing functions

### 4.1. Identification and authentication

#### 4.1.1. Motion sensor identification and authentication

UIA\_201 The VU shall be able to establish, for every interaction, the identity of the motion sensor it is connected to.

UIA\_202 The identity of the motion sensor shall consist of the sensor approval number and the sensor serial number.

UIA\_203 The VU shall authenticate the motion sensor it is connected to:

- at motion sensor connection,
- at each calibration of the recording equipment,
- at power supply recovery.

Authentication shall be mutual and triggered by the VU.

UIA\_204 The VU shall periodically (period TBD by manufacturer and more frequently than once per hour) re-identify and re-authenticate the motion sensor it is connected to, and ensure that the motion sensor identified during the last calibration of the recording equipment has not been changed.

UIA\_205 The VU shall detect and prevent use of authentication data that has been copied and replayed.

UIA\_206 After (TBD by manufacturer and not more than 20) consecutive unsuccessful authentication attempts have been detected, and/or after detecting that the identity of the motion sensor has changed while not authorised (i.e. while not during a calibration of the recording equipment), the SEF shall:

- generate an audit record of the event,
- warn the user,
- continue to accept and use non secured motion data sent by the motion sensor.

#### 4.1.2. *User identification and authentication*

UIA\_207 The VU shall permanently and selectively track the identity of two users, by monitoring the tachograph cards inserted in respectively the driver slot and the co-driver slot of the equipment.

UIA\_208 The user identity shall consist of:

- a user group:
  - DRIVER (driver card),
  - CONTROLLER (control card),
  - WORKSHOP (workshop card),
  - COMPANY (company card),
  - UNKNOWN (no card inserted),
- a user ID, composed of:
  - the card issuing Member State code and of the card number,
  - UNKNOWN if user group is UNKNOWN.

UNKNOWN identities may be implicitly or explicitly known.

UIA\_209 The VU shall authenticate its users at card insertion.

UIA\_210 The VU shall re-authenticate its users:

- at power supply recovery,
- periodically or after occurrence of specific events (TBD by manufacturers and more frequently than once per day).

UIA\_211 Authentication shall be performed by means of proving that the card inserted is a valid tachograph card, possessing security data that only the system could distribute. Authentication shall be mutual and triggered by the VU.

UIA\_212 In addition to the above, workshops shall be required to be successfully authenticated through a PIN check. PINs shall be at least 4 characters long.

Note: In the case the PIN is transferred to the VU from an outside equipment located in the vicinity of the VU, PIN confidentiality need not be protected during the transfer.

UIA\_213 The VU shall detect and prevent use of authentication data that has been copied and replayed.

UIA\_214 After 5 consecutive unsuccessful authentication attempts have been detected, the SEF shall:

- generate an audit record of the event,
- warn the user,
- assume the user as UNKNOWN, and the card as non valid (definition z) and requirement 007).

#### 4.1.3. *Remotely connected company identification and authentication*

Company remote connection capability is optional. This paragraph therefore applies only if this feature is implemented.

- UIA\_215 For every interaction with a remotely connected company, the VU shall be able to establish the company's identity.
- UIA\_216 The remotely connected company's identity shall consist of its company card issuing Member State code and of its company card number.
- UIA\_217 The VU shall successfully authenticate the remotely connected company before allowing any data export to it.
- UIA\_218 Authentication shall be performed by means of proving that the company owns a valid company card, possessing security data that only the system could distribute.
- UIA\_219 The VU shall detect and prevent use of authentication data that has been copied and replayed.
- UIA\_220 After 5 consecutive unsuccessful authentication attempts have been detected, the VU shall:
- warn the remotely connected company.

#### 4.1.4. *Management device identification and authentication*

VU manufacturers may foresee dedicated devices for additional VU management functions (e.g. Software upgrading, security data reloading, ...). This paragraph therefore applies only if this feature is implemented.

- UIA\_221 For every interaction with a management device, the VU shall be able to establish the device identity.
- UIA\_222 Before allowing any further interaction, the VU shall successfully authenticate the management device.
- UIA\_223 The VU shall detect and prevent use of authentication data that has been copied and replayed.

### 4.2. **Access control**

Access controls ensure that information is read from, created in, or modified into the TOE only by those authorised to do so.

It must be noted that the user data recorded by the VU, although presenting privacy or commercial sensitivity aspects, are not of a confidential nature. Therefore, the functional requirement related to data read access rights (requirement 011) is not the subject of a security enforcing function.

#### 4.2.1. *Access control policy*

- ACC\_201 The VU shall manage and check access control rights to functions and to data.

#### 4.2.2. *Access rights to functions*

- ACC\_202 The VU shall enforce the mode of operation selection rules (requirements 006 to 009).
- ACC\_203 The VU shall use the mode of operation to enforce the functions access control rules (requirement 010).

#### 4.2.3. *Access rights to data*

- ACC\_204 The VU shall enforce the VU identification data write access rules (requirement 076)
- ACC\_205 The VU shall enforce the paired motion sensor identification data write access rules (requirements 079 and 155)
- ACC\_206 After the VU activation, the VU shall ensure that only in calibration mode, may calibration data be input into the VU and stored into its data memory (requirements 154 and 156).
- ACC\_207 After the VU activation, the VU shall enforce calibration data write and delete access rules (requirement 097).

ACC\_208 After the VU activation, the VU shall ensure that only in calibration mode, may time adjustment data be input into the VU and stored into its data memory (This requirement does not apply to small time adjustments allowed by requirements 157 and 158).

ACC\_209 After the VU activation, the VU shall enforce time adjustment data write and delete access rules (requirement 100).

ACC\_210 The VU shall enforce appropriate read and write access rights to security data (requirement 080).

#### 4.2.4. File structure and access conditions

ACC\_211 Application and data files structure and access conditions shall be created during the manufacturing process, and then locked from any future modification or deletion.

### 4.3. Accountability

ACT\_201 The VU shall ensure that drivers are accountable for their activities (requirements 081, 084, 087, 105a, 105b, 109 and 109a).

ACT\_202 The VU shall hold permanent identification data (requirement 075).

ACT\_203 The VU shall ensure that workshops are accountable for their activities (requirements 098, 101 and 109).

ACT\_204 The VU shall ensure that controllers are accountable for their activities (requirements 102, 103 and 109).

ACT\_205 The VU shall record odometer data (requirement 090) and detailed speed data (requirement 093).

ACT\_206 The VU shall ensure that user data related to requirements 081 to 093 and 102 to 105b inclusive are not modified once recorded, except when becoming oldest stored data to be replaced by new data.

ACT\_207 The VU shall ensure that it does not modify data already stored in a tachograph card (requirements 109 and 109a) except for replacing oldest data by new data (requirement 110) or in the case described in Appendix 1 Paragraph 2.1 Note.

### 4.4. Audit

Audit capabilities are required only for events that may indicate a manipulation or a security breach attempt. It is not required for the normal exercising of rights even if relevant to security.

AUD\_201 The VU shall, for events impairing the security of the VU, record those events with associated data (requirements 094, 096 and 109).

AUD\_202 The events affecting the security of the VU are the following:

- Security breach attempts,
  - motion sensor authentication failure,
  - tachograph card authentication failure,
  - unauthorised change of motion sensor,
  - card data input integrity error,
  - stored user data integrity error,
  - internal data transfer error,
  - unauthorised case opening,
  - hardware sabotage,

- last card session not correctly closed,
- motion data error event,
- power supply interruption event,
- VU internal fault.

AUD\_203 The VU shall enforce audit records storage rules (requirement 094 and 096).

AUD\_204 The VU shall store audit records generated by the motion sensor in its data memory.

AUD\_205 It shall be possible to print, display and download audit records.

#### 4.5. **Object re-use**

REU\_201 The VU shall ensure that temporary storage objects can be re-used without this involving inadmissible information flow.

#### 4.6. **Accuracy**

##### 4.6.1. *Information flow control policy*

ACR\_201 The VU shall ensure that user data related to requirements 081, 084, 087, 090, 093, 102, 104, 105, 105a and 109 may only be processed from the right input sources:

- vehicle motion data,
- VU's real time clock,
- recording equipment calibration parameters,
- tachograph cards,
- user's inputs.

ACR\_201a The VU shall ensure that user data related to requirement 109a may only be entered for the period last card withdrawal — current insertion (requirement 050a).

##### 4.6.2. *Internal data transfers*

The requirements of this paragraph apply only if the VU makes use of physically separated parts.

ACR\_202 If data are transferred between physically separated parts of the VU, the data shall be protected from modification.

ACR\_203 Upon detection of a data transfer error during an internal transfer, transmission shall be repeated and the SEF shall generate an audit record of the event.

##### 4.6.3. *Stored data integrity*

ACR\_204 The VU shall check user data stored in the data memory for integrity errors.

ACR\_205 Upon detection of a stored user data integrity error, the SEF shall generate an audit record.

#### 4.7. **Reliability of service**

##### 4.7.1. *Tests*

RLB\_201 All commands, actions or test points, specific to the testing needs of the manufacturing phase of the VU shall be disabled or removed before the VU activation. It shall not be possible to restore them for later use.

RLB\_202 The VU shall run self tests, during initial start-up, and during normal operation to verify its correct operation. The VU self tests shall include a verification of the integrity of security data and a verification of the integrity of stored executable code (if not in ROM).

RLB\_203 Upon detection of an internal fault during self test, the SEF shall:

- generate an audit record (except in calibration mode) (VU internal fault),
- Preserve the stored data integrity.

#### 4.7.2. *Software*

RLB\_204 There shall be no way to analyse or debug software in the field after the VU activation.

RLB\_205 Inputs from external sources shall not be accepted as executable code.

#### 4.7.3. *Physical protection*

RLB\_206 If the VU is designed so that it can be opened, the VU shall detect any case opening, except in calibration mode, even without external power supply for a minimum of six months. In such a case, the SEF shall generate an audit record (It is acceptable that the audit record is generated and stored after power supply reconnection).

If the VU is designed so that it cannot be opened, it shall be designed such that physical tampering attempts can be easily detected (e.g. through visual inspection).

RLB\_207 After its activation, the VU shall detect specified (TBD by manufacturer) hardware sabotage.

RLB\_208 In the case described above, the SEF shall generate an audit record and the VU shall: (TBD by manufacturer).

#### 4.7.4. *Power supply interruptions*

RLB\_209 The VU shall detect deviations from the specified values of the power supply, including cut-off.

RLB\_210 In the case described above, the SEF shall:

- generate an audit record (except in calibration mode),
- preserve the secure state of the VU,
- maintain the security functions, related to components or processes still operational,
- preserve the stored data integrity.

#### 4.7.5. *Reset conditions*

RLB\_211 In case of a power supply interruption, or if a transaction is stopped before completion, or on any other reset conditions, the VU shall be reset cleanly.

#### 4.7.6. *Data availability*

RLB\_212 The VU shall ensure that access to resources is obtained when required and that resources are not requested nor retained unnecessarily.

RLB\_213 The VU must ensure that cards cannot be released before relevant data have been stored to them (requirements 015 and 016)

RLB\_214 In the case described above, the SEF shall generate an audit record of the event.

#### 4.7.7. *Multiple applications*

RLB\_215 If the VU provides applications other than the tachograph application, all applications shall be physically and/or logically separated from each other. These applications shall not share security data. Only one task shall be active at a time.

### 4.8. **Data exchange**

This paragraph addresses data exchange between the VU and connected devices.

#### 4.8.1. *Data exchange with motion sensor*

DEX\_201 The VU shall verify the integrity and authenticity of motion data imported from the motion sensor



DEX\_202 Upon detection of a motion data integrity or authenticity error, the SEF shall:

- generate an audit record,
- continue to use imported data.

#### 4.8.2. Data exchange with tachograph cards

DEX\_203 The VU shall verify the integrity and authenticity of data imported from tachograph cards.

DEX\_204 Upon detection of card data integrity or authenticity error, the VU shall:

- generate an audit record,
- not use the data.

DEX\_205 The VU shall export data to tachograph smart cards with associated security attributes such that the card will be able to verify its integrity and authenticity.

#### 4.8.3. Data exchange with external storage media (downloading function)

DEX\_206 The VU shall generate an evidence of origin for data downloaded to external media.

DEX\_207 The VU shall provide a capability to verify the evidence of origin of downloaded data to the recipient.

DEX\_208 The VU shall download data to external storage media with associated security attributes such that downloaded data integrity and authenticity can be verified.

### 4.9. Cryptographic support

The requirements of this paragraph are applicable only where needed, depending upon security mechanisms used and upon the manufacturer's solutions.

CSP\_201 Any cryptographic operation performed by the VU shall be in accordance with a specified algorithm and a specified key size.

CSP\_202 If the VU generates cryptographic keys, it shall be in accordance with specified cryptographic key generation algorithms and specified cryptographic key sizes.

CSP\_203 If the VU distributes cryptographic keys, it shall be in accordance with specified key distribution methods.

CSP\_204 If the VU accesses cryptographic keys, it shall be in accordance with specified cryptographic keys access methods.

CSP\_205 If the VU destroys cryptographic keys, it shall be in accordance with specified cryptographic keys destruction methods.

### 5. Definition of security mechanisms

Required security mechanisms are specified in Appendix 11.

All other security mechanisms are to be defined by manufacturers.

### 6. Minimum strength of security mechanisms

The minimum strength of the Vehicle Unit security mechanisms is **High**, as defined in (ITSEC).

### 7. Level of assurance

The target level of assurance for the Vehicle Unit is ITSEC level **E3**, as defined in (ITSEC).

8. Rationale

The following matrixes give a rationale for the SEFs by showing:

- which SEFs or means counteract which threats,
  
- which SEFs fulfil which IT security objectives.

|                                                        | Threats |                |        |       |        |                        |                    |       |             |              |          |             |               |             | IT Objectives |               |          |             |        |                |       |                |           |        |            |             |                       |   |
|--------------------------------------------------------|---------|----------------|--------|-------|--------|------------------------|--------------------|-------|-------------|--------------|----------|-------------|---------------|-------------|---------------|---------------|----------|-------------|--------|----------------|-------|----------------|-----------|--------|------------|-------------|-----------------------|---|
|                                                        | Access  | Identification | Faults | Tests | Design | Calibration_Parameters | Card_Data_Exchange | Clock | Environment | Fake_Devices | Hardware | Motion_Data | Non_Activated | Output_Data | Power_Supply  | Security_Data | Software | Stored_Data | Access | Accountability | Audit | Authentication | Integrity | Output | Processing | Reliability | Secured_Data_Exchange |   |
| Physical Personnel Procedural Means                    |         |                |        |       |        |                        |                    |       |             |              |          |             |               |             |               |               |          |             |        |                |       |                |           |        |            |             |                       |   |
| Development                                            |         |                | x      | x     | x      |                        |                    |       |             |              |          |             |               |             |               |               |          |             |        |                |       |                |           |        |            |             |                       |   |
| Manufacturing                                          |         |                |        | x     | x      |                        |                    |       |             |              |          |             |               |             |               |               |          |             |        |                |       |                |           |        |            |             |                       |   |
| Delivery                                               |         |                |        |       |        |                        |                    |       |             |              |          |             | x             |             |               |               |          |             |        |                |       |                |           |        |            |             |                       |   |
| Activation                                             | x       |                |        |       |        |                        |                    |       |             |              |          | x           |               |             |               |               |          |             |        |                |       |                |           |        |            |             |                       |   |
| Security data generation                               |         |                |        |       |        |                        |                    |       |             |              |          |             |               |             |               |               | x        |             |        |                |       |                |           |        |            |             |                       |   |
| Security data transport                                |         |                |        |       |        |                        |                    |       |             |              |          |             |               |             |               |               | x        |             |        |                |       |                |           |        |            |             |                       |   |
| Card availability                                      |         | x              |        |       |        |                        |                    |       |             |              |          |             |               |             |               |               |          |             |        |                |       |                |           |        |            |             |                       |   |
| One driver card                                        |         | x              |        |       |        |                        |                    |       |             |              |          |             |               |             |               |               |          |             |        |                |       |                |           |        |            |             |                       |   |
| Card traceability                                      |         | x              |        |       |        |                        |                    |       |             |              |          |             |               |             |               |               |          |             |        |                |       |                |           |        |            |             |                       |   |
| Approved workshops                                     |         |                |        |       |        | x                      |                    | x     |             |              |          |             |               |             |               |               |          |             |        |                |       |                |           |        |            |             |                       |   |
| Regular inspection calibration                         |         |                |        |       |        | x                      |                    | x     |             |              | x        | x           |               |             |               | x             |          |             |        |                |       |                |           |        |            |             |                       |   |
| Faithful workshops                                     |         |                |        |       |        | x                      |                    | x     |             |              |          |             |               |             |               |               |          |             |        |                |       |                |           |        |            |             |                       |   |
| Faithful drivers                                       |         | x              |        |       |        |                        |                    |       |             |              |          |             |               |             |               |               |          |             |        |                |       |                |           |        |            |             |                       |   |
| Law enforcement controls                               |         | x              |        |       |        | x                      |                    | x     | x           |              | x        |             | x             |             | x             |               | x        | x           |        |                |       |                |           |        |            |             |                       |   |
| Software upgrade                                       |         |                |        |       |        |                        |                    |       |             |              |          |             |               |             |               |               |          | x           |        |                |       |                |           |        |            |             |                       |   |
| Security enforcing functions                           |         |                |        |       |        |                        |                    |       |             |              |          |             |               |             |               |               |          |             |        |                |       |                |           |        |            |             |                       |   |
| Identification and authentication                      |         |                |        |       |        |                        |                    |       |             |              |          |             |               |             |               |               |          |             |        |                |       |                |           |        |            |             |                       |   |
| UIA_201 Sensor identification                          |         |                |        |       |        |                        |                    |       | x           | x            |          |             |               |             |               |               |          |             |        |                |       | x              |           |        |            |             |                       | x |
| UIA_202 Sensor identity                                |         |                |        |       |        |                        |                    |       | x           | x            |          |             |               |             |               |               |          |             |        |                |       | x              |           |        |            |             |                       | x |
| UIA_203 Sensor authentication                          |         |                |        |       |        |                        |                    |       | x           | x            |          |             |               |             |               |               |          |             |        |                |       | x              |           |        |            |             |                       | x |
| UIA_204 Sensor re-identification and re-authentication |         |                |        |       |        |                        |                    |       | x           | x            |          |             |               |             |               |               |          |             |        |                |       | x              |           |        |            |             |                       | x |
| UIA_205 Unforgeable authentication                     |         |                |        |       |        |                        |                    |       | x           | x            |          |             |               |             |               |               |          |             |        |                |       | x              |           |        |            |             |                       |   |
| UIA_206 Authentication failure                         |         |                |        |       |        |                        |                    |       | x           | x            |          |             |               |             |               |               |          |             |        |                |       | x              |           |        |            |             | x                     |   |
| UIA_207 Users identification                           | x       | x              |        |       |        |                        |                    |       | x           |              |          |             |               |             |               |               |          |             | x      |                |       | x              |           |        |            |             |                       | x |
| UIA_208 User identity                                  | x       | x              |        |       |        |                        |                    |       | x           |              |          |             |               |             |               |               |          |             | x      |                |       | x              |           |        |            |             |                       | x |
| UIA_209 User authentication                            | x       | x              |        |       |        |                        |                    |       | x           |              |          |             |               |             |               |               |          |             | x      |                |       | x              |           |        |            |             |                       | x |
| UIA_210 User re-authentication                         | x       | x              |        |       |        |                        |                    |       | x           |              |          |             |               |             |               |               |          |             | x      |                |       | x              |           |        |            |             |                       | x |
| UIA_211 Authentication means                           | x       | x              |        |       |        |                        |                    |       | x           |              |          |             |               |             |               |               |          |             | x      |                |       | x              |           |        |            |             |                       |   |
| UIA_212 PIN checks                                     | x       | x              |        |       |        | x                      |                    | x     |             |              |          |             |               |             |               |               |          |             | x      |                |       | x              |           |        |            |             |                       |   |
| UIA_213 Unforgeable authentication                     | x       | x              |        |       |        |                        |                    |       | x           |              |          |             |               |             |               |               |          |             | x      |                |       | x              |           |        |            |             |                       |   |

|                                              | Threats |                |        |       |        |                        |                    |       |             |              |          |             |               |             |              |               |          | IT Objectives |        |                |       |                |           |        |            |             |                       |  |
|----------------------------------------------|---------|----------------|--------|-------|--------|------------------------|--------------------|-------|-------------|--------------|----------|-------------|---------------|-------------|--------------|---------------|----------|---------------|--------|----------------|-------|----------------|-----------|--------|------------|-------------|-----------------------|--|
|                                              | Access  | Identification | Faults | Tests | Design | Calibration_Parameters | Card_Data_Exchange | Clock | Environment | Fake_Devices | Hardware | Motion_Data | Non_Activated | Output_Data | Power_Supply | Security_Data | Software | Stored_Data   | Access | Accountability | Audit | Authentication | Integrity | Output | Processing | Reliability | Secured_Data_Exchange |  |
| UIA_214 Authentication failure               | x       | x              |        |       |        |                        |                    |       | x           |              |          |             |               |             |              |               |          |               |        | x              |       |                |           |        |            |             |                       |  |
| UIA_215 Remote user identification           | x       | x              |        |       |        |                        |                    |       |             |              |          |             |               |             |              |               |          | x             |        | x              |       |                |           |        |            |             | x                     |  |
| UIA_216 Remote user identity                 | x       | x              |        |       |        |                        |                    |       |             |              |          |             |               |             |              |               |          | x             |        | x              |       |                |           |        |            |             |                       |  |
| UIA_217 Remote user authentication           | x       | x              |        |       |        |                        |                    |       |             |              |          |             |               |             |              |               |          | x             |        | x              |       |                |           |        |            |             | x                     |  |
| UIA_218 Authentication means                 | x       | x              |        |       |        |                        |                    |       |             |              |          |             |               |             |              |               |          | x             |        | x              |       |                |           |        |            |             |                       |  |
| UIA_219 Unforgeable authentication           | x       | x              |        |       |        |                        |                    |       |             |              |          |             |               |             |              |               |          | x             |        | x              |       |                |           |        |            |             |                       |  |
| UIA_220 Authentication failure               | x       | x              |        |       |        |                        |                    |       |             |              |          |             |               |             |              |               |          |               |        |                |       |                |           |        |            |             |                       |  |
| UIA_221 Management device identification     | x       | x              |        |       |        |                        |                    |       |             |              |          |             |               |             |              |               |          | x             |        | x              |       |                |           |        |            |             |                       |  |
| UIA_222 Management device authentication     | x       | x              |        |       |        |                        |                    |       |             |              |          |             |               |             |              |               |          | x             |        | x              |       |                |           |        |            |             |                       |  |
| UIA_223 Unforgeable authentication           | x       | x              |        |       |        |                        |                    |       |             |              |          |             |               |             |              |               |          | x             |        | x              |       |                |           |        |            |             |                       |  |
| Access Control                               |         |                |        |       |        |                        |                    |       |             |              |          |             |               |             |              |               |          |               |        |                |       |                |           |        |            |             |                       |  |
| ACC_201 Access control policy                | x       |                |        |       |        | x                      | x                  |       |             |              |          |             |               |             |              |               | x        | x             | x      |                |       |                |           |        |            |             |                       |  |
| ACC_202 Access rights to functions           | x       |                |        |       |        | x                      | x                  |       |             |              |          |             |               |             |              |               |          |               |        | x              |       |                |           |        |            |             |                       |  |
| ACC_203 Access rights to functions           | x       |                |        |       |        | x                      | x                  |       |             |              |          |             |               |             |              |               |          |               |        | x              |       |                |           |        |            |             |                       |  |
| ACC_204 VU ID                                |         |                |        |       |        |                        |                    |       |             |              |          |             |               |             |              |               |          |               | x      | x              |       |                |           |        |            |             |                       |  |
| ACC_205 Connected sensor ID                  |         |                |        |       |        |                        |                    |       | x           |              |          |             |               |             |              |               |          |               | x      | x              |       |                |           |        |            |             |                       |  |
| ACC_206 Calibration data                     | x       |                |        |       |        | x                      |                    |       |             |              |          |             |               |             |              |               |          |               | x      | x              |       |                |           |        |            |             |                       |  |
| ACC_207 Calibration data                     |         |                |        |       |        | x                      |                    |       |             |              |          |             |               |             |              |               |          |               | x      | x              |       |                |           |        |            |             |                       |  |
| ACC_208 Time adjustment data                 |         |                |        |       |        |                        |                    |       | x           |              |          |             |               |             |              |               |          |               | x      | x              |       |                |           |        |            |             |                       |  |
| ACC_209 Time adjustment data                 |         |                |        |       |        |                        |                    |       | x           |              |          |             |               |             |              |               |          |               | x      | x              |       |                |           |        |            |             |                       |  |
| ACC_210 Security data                        |         |                |        |       |        |                        |                    |       |             |              |          |             |               |             |              |               |          |               | x      | x              | x     |                |           |        |            |             |                       |  |
| ACC_211 File structure and access conditions | x       |                |        |       |        | x                      |                    |       |             |              |          |             |               |             |              |               |          | x             | x      | x              |       |                |           |        |            |             |                       |  |
| Accountability                               |         |                |        |       |        |                        |                    |       |             |              |          |             |               |             |              |               |          |               |        |                |       |                |           |        |            |             |                       |  |
| ACT_201 Drivers accountability               |         |                |        |       |        |                        |                    |       |             |              |          |             |               |             |              |               |          |               |        |                | x     |                |           |        |            |             |                       |  |
| ACT_202 VU ID data                           |         |                |        |       |        |                        |                    |       |             |              |          |             |               |             |              |               |          |               |        | x              | x     |                |           |        |            |             |                       |  |
| ACT_203 Workshops accountability             |         |                |        |       |        |                        |                    |       |             |              |          |             |               |             |              |               |          |               |        | x              |       |                |           |        |            |             |                       |  |
| ACT_204 Controllers accountability           |         |                |        |       |        |                        |                    |       |             |              |          |             |               |             |              |               |          |               |        | x              |       |                |           |        |            |             |                       |  |
| ACT_205 Vehicle movement accountability      |         |                |        |       |        |                        |                    |       |             |              |          |             |               |             |              |               |          |               |        | x              |       |                |           |        |            |             |                       |  |
| ACT_206 Accountability data modification     |         |                |        |       |        |                        |                    |       |             |              |          |             |               |             |              |               |          |               | x      |                |       |                | x         |        |            |             | x                     |  |
| ACT_207 Accountability data modification     |         |                |        |       |        |                        |                    |       |             |              |          |             |               |             |              |               |          |               | x      |                |       |                | x         |        |            |             | x                     |  |





## TACHOGRAPH CARD GENERIC SECURITY TARGET

**1. Introduction**

This document contains a description of the tachograph card, of the threats it must be able to counteract and of the security objectives it must achieve. It specifies the required security enforcing functions. It states the claimed minimum strength of security mechanisms, and the required level of assurance for the development and the evaluation.

Requirements referred to in the document, are those of the body of Annex I B. For clarity of reading, duplication sometimes arises between Annex I B body requirements and security target requirements. In case of ambiguity between a security target requirement and the Annex I B requirement referred by this security target requirement, the Annex I B body requirement shall prevail.

Annex I B body requirements not referred by security targets are not the subject of security enforcing functions.

A tachograph card is a standard smart card carrying a dedicated tachograph application, and shall comply with up-to-date functional and assurance security requirements applicable to smart cards. This security target therefore incorporates only the extra security requirements needed by the tachograph application.

Unique labels have been assigned to threats, objectives, procedural means and SEF specifications for the purpose of traceability to development and evaluation documentation.

**2. Abbreviations, definitions and references****2.1. Abbreviations**

|     |                                                                                                  |
|-----|--------------------------------------------------------------------------------------------------|
| IC  | Integrated Circuit (electronic component designed to perform processing and/or memory functions) |
| OS  | Operating system                                                                                 |
| PIN | Personal identification number                                                                   |
| ROM | Read only memory                                                                                 |
| SFP | Security functions policy                                                                        |
| TBD | To be defined                                                                                    |
| TOE | Target of evaluation                                                                             |
| TSF | TOE security function                                                                            |
| VU  | Vehicle unit.                                                                                    |

**2.2. Definitions**

|                    |                                                                                                                                                                                                                      |
|--------------------|----------------------------------------------------------------------------------------------------------------------------------------------------------------------------------------------------------------------|
| Digital tachograph | Recording equipment.                                                                                                                                                                                                 |
| Sensitive data     | Data stored by the tachograph card that need to be protected for integrity, unauthorised modification and confidentiality (where applicable for security data). Sensitive data includes security data and user data. |
| Security data      | The specific data needed to support security enforcing functions (e.g. crypto keys).                                                                                                                                 |
| System             | Equipment, people or organisations involved in any way with the recording equipment.                                                                                                                                 |
| User               | Any entity (human user or external IT entity) outside the TOE that interacts with the TOE (when not used in the expression "user data").                                                                             |

|                                |                                                                                                                                                                     |
|--------------------------------|---------------------------------------------------------------------------------------------------------------------------------------------------------------------|
| User data                      | Sensitive data stored in the tachograph card, other than security data. User data include identification data and activity data.                                    |
| Identification data            | Identification data include card identification data and cardholder identification data.                                                                            |
| Card identification data       | User data related to card identification as defined by requirements 190, 191, 192, 194, 215, 231 and 235.                                                           |
| Cardholder identification data | User data related to cardholder identification as defined by requirements 195, 196, 216, 232 and 236.                                                               |
| Activity data                  | Activity data include cardholder activities data, events and faults data and control activity data.                                                                 |
| Cardholder activities data     | User data related to the activities carried by the cardholder as defined by requirements 197, 199, 202, 212, 212a, 217, 219, 221, 226, 227, 229, 230a, 233 and 237. |
| Events and faults data         | User data related to events or faults as defined by requirements 204, 205, 207, 208 and 223.                                                                        |
| Control activity data          | User data related to law enforcement controls as defined by requirements 210 and 225.                                                                               |

### 2.3. References

|       |                                                                                                                                                                         |
|-------|-------------------------------------------------------------------------------------------------------------------------------------------------------------------------|
| ITSEC | ITSEC Information Technology Security Evaluation Criteria 1991                                                                                                          |
| IC PP | Smartcard Integrated Circuit Protection Profile — version 2.0 — issue September 1998. Registered at French certification body under the number PP/9806                  |
| ES PP | Smart Card Integrated Circuit With Embedded Software Protection Profile — version 2.0 — issue June 99. Registered at French certification body under the number PP/9911 |

## 3. Product Rationale

### 3.1. Tachograph card description and method of use

A tachograph card is a smart card, as described in (IC PP) and (ES PP), carrying an application intended for its use with the recording equipment.

The basic functions of the tachograph card are:

- to store card identification and card holder identification data. These data are used by the vehicle unit to identify the cardholder, provide accordingly functions and data access rights, and ensure cardholder accountability for his activities,
- to store cardholder activities data, events and faults data and control activities data, related to the cardholder.

A tachograph card is therefore intended to be used by a card interface device of a vehicle unit. It may also be used by any card reader (e.g. of a personal computer) which shall have full read access right on any user data.

During the end-usage phase of a tachograph card life cycle (phase 7 of life-cycle as described in (ES PP)), vehicle units only may write user data to the card.

The functional requirements for a tachograph card are specified in Annex I B body text and Appendix 2.

### 3.2. Tachograph card life cycle

The tachograph card life cycle conforms to smart card life cycle described in (ES PP).

### 3.3. Threats

In addition to the smart card general threats listed in (ES PP) and (IC PP), the tachograph card may face the following threats:

#### 3.3.1. Final aims

The final aim of attackers will be to modify user data stored within the TOE.

|                 |                                                                                                                                                                                                                                                                             |
|-----------------|-----------------------------------------------------------------------------------------------------------------------------------------------------------------------------------------------------------------------------------------------------------------------------|
| T.Ident_Data    | A successful modification of identification data held by the TOE (e.g. the type of card, or the card expiry date or the cardholder identification data) would allow a fraudulent use of the TOE and would be a major threat to the global security objective of the system. |
| T.Activity_Data | A successful modification of activity data stored in the TOE would be a threat to the security of the TOE.                                                                                                                                                                  |
| T.Data_Exchange | A successful modification of activity data (addition, deletion, modification) during import or export would be a threat to the security of the TOE.                                                                                                                         |

#### 3.3.2. Attack paths

TOE's assets may be attacked by:

- trying to gain illicit knowledge of TOE's hardware and software design and especially of its security functions or security data. Illicit knowledge may be gained through attacks to designer or manufacturer material (theft, bribery, ...) or through direct examination of the TOE (physical probing, inference analysis, ...),
- taking advantage of weaknesses in TOE design or realisation (exploit errors in hardware, errors in software, transmission faults, errors induced in TOE by environmental stress, exploit weaknesses of security functions such as authentication procedures, data access control, cryptographic operations, ...),
- modifying the TOE or its security functions through physical, electrical or logical attacks or combination of these.

### 3.4. Security Objectives

The main security objective of the entire digital tachograph system is the following:

|        |                                                                                                                                                                                                                                         |
|--------|-----------------------------------------------------------------------------------------------------------------------------------------------------------------------------------------------------------------------------------------|
| O.Main | The data to be checked by control authorities must be available and reflect fully and accurately the activity of controlled drivers and vehicles in terms of driving, work, availability and rest period and in terms of vehicle speed. |
|--------|-----------------------------------------------------------------------------------------------------------------------------------------------------------------------------------------------------------------------------------------|

Therefore the main security objectives of the TOE, contributing to this global security objective are the following:

|                            |                                                                                                                               |
|----------------------------|-------------------------------------------------------------------------------------------------------------------------------|
| O.Card_Identification_Data | The TOE must preserve card identification data and cardholder identification data stored during card personalisation process, |
| O.Card_Activity_Storage    | The TOE must preserve user data stored in the card by vehicle units.                                                          |

### 3.5. Information technology security objectives

In addition to the smart card general security objectives listed in (ES PP) and (IC PP), the specific IT security objectives of the TOE that contributes to its main security objectives during its end-usage life-cycle phase are the following:

|                         |                                                                                                                                                                |
|-------------------------|----------------------------------------------------------------------------------------------------------------------------------------------------------------|
| O.Data_Access           | The TOE must limit user data write access rights to authenticated vehicle units,                                                                               |
| O.Secure_Communications | The TOE must be able to support secure communication protocols and procedures between the card and the card interface device when required by the application. |

### 3.6. Physical, personnel or procedural means

The physical, personnel or procedural requirements that contribute to the security of the TOE are listed in (ES PP) and (IC PP) (chapters security objectives for the environment).



#### 4. Security enforcing functions

This paragraph refines some of the permitted operations such as assignment or selection of (ES PP) and provides additional SEF functional requirements.

##### 4.1. Compliance to protection profiles

CPP\_301 The TOE shall comply with (IC PP).

CPP\_302 The TOE shall comply with (ES PP) as refined further.

##### 4.2. User identification and authentication

The card must identify the entity in which it is inserted and know whether it is an authenticated vehicle unit or not. The card may export any user data whatever the entity it is connected to, except the control card which may export card holder identification data to authenticated vehicle units only (such that a controller is ensured that the vehicle unit is not a fake one by seeing his name on display or printouts).

###### 4.2.1. User identification

**Assignment** (FIA\_UID.1.1) *List of TSF mediated actions*: none.

**Assignment** (FIA\_ATD.1.1) *List of security attributes*:

USER\_GROUP VEHICLE\_UNIT, NON\_VEHICLE\_UNIT,

USER\_ID Vehicle Registration Number (VRN) and registering Member State Code (USER\_ID is known for USER\_GROUP = VEHICLE\_UNIT only).

###### 4.2.2. User authentication

**Assignment** (FIA\_UAU.1.1) *List of TSF mediated actions*:

- Driver and Workshop cards: export user data with security attributes (card data download function),
- Control card: export user data without security attributes except cardholder identification data.

UIA\_301 Authentication of a vehicle unit shall be performed by means of proving that it possesses security data that only the system could distribute.

**Selection** (FIA\_UAU.3.1 and FIA\_UAU.3.2): prevent.

**Assignment** (FIA\_UAU.4.1) *Identified authentication mechanism(s)*: any authentication mechanism.

UIA\_302 The Workshop card shall provide an additional authentication mechanism by checking a PIN code (This mechanism is intended for the vehicle unit to ensure the identity of the card holder, it is not intended to protect workshop card content).

###### 4.2.3. Authentication failures

The following assignments describe the card reaction for each single user authentication failure.

**Assignment** (FIA\_AFL.1.1) *Number*: 1, *list of authentication events*: authentication of a card interface device.

**Assignment** (FIA\_AFL.1.2) *List of actions*:

- warn the entity connected,
- assume the user as NON\_VEHICLE\_UNIT.

The following assignments describe the card reaction in the case of failure of the additional authentication mechanism required in UIA\_302.

**Assignment** (FIA\_AFL.1.1) *Number*: 5, *list of authentication events*: PIN checks (workshop card).

**Assignment** (FIA\_AFL.1.2) *List of actions:*

- warn the entity connected,
- block the PIN check procedure such that any subsequent PIN check attempt will fail,
- be able to indicate to subsequent users the reason of the blocking.

#### 4.3. **Access control**

##### 4.3.1. *Access control policy*

During end-usage phase of its life cycle, the tachograph card is the subject of one single access control security function policy (SFP) named AC\_SFP.

**Assignment** (FDP\_ACC.2.1) *Access control SFP: AC\_SFP.*

##### 4.3.2. *Access control functions*

**Assignment** (FDP\_ACF.1.1) *Access control SFP: AC\_SFP.*

**Assignment** (FDP\_ACF.1.1) *Named group of security attributes: USER\_GROUP.*

**Assignment** (FDP\_ACF.1.2) *Rules governing access among controlled subjects and controlled objects using controlled operations on controlled objects:*

|                 |                                                                                                                                                                                               |
|-----------------|-----------------------------------------------------------------------------------------------------------------------------------------------------------------------------------------------|
| GENERAL_READ:   | User data may be read from the TOE by any user, except cardholder identification data which may be read from control cards by VEHICLE_UNIT only.                                              |
| IDENTIF_WRITE:  | Identification data may only be written once and before the end of phase 6 of card's life-cycle. No user may write or modify identification data during end-usage phase of card's life-cycle. |
| ACTIVITY_WRITE: | Activity data may be written to the TOE by VEHICLE_UNIT only.                                                                                                                                 |
| SOFT_UPGRADE:   | No user may upgrade TOE's software.                                                                                                                                                           |
| FILE_STRUCTURE: | Files structure and access conditions shall be created before end of phase 6 of TOE's life-cycle and then locked from any future modification or deletion by any user.                        |

#### 4.4. **Accountability**

ACT\_301 The TOE shall hold permanent identification data.

ACT\_302 There shall be an indication of the time and date of the TOE's personalisation. This indication shall remain unalterable.

#### 4.5. **Audit**

The TOE must monitor events that indicate a potential violation of its security.

**Assignment** (FAU\_SAA.1.2) *Subset of defined auditable events:*

- cardholder authentication failure (5 consecutive unsuccessful PIN checks),
- self test error,
- stored data integrity error,
- activity data input integrity error.

#### 4.6. **Accuracy**

##### 4.6.1. *Stored data integrity*

**Assignment** (FDP\_SDI.2.2) *Actions to be taken: warn the entity connected,*

##### 4.6.2. *Basic data authentication*

**Assignment** (FDP\_DAU.1.1) *List of objects or information types: activity data.*

**Assignment** (FDP\_DAU.1.2) *List of subjects: any.*

#### 4.7. **Reliability of service**

##### 4.7.1. *Tests*

**Selection** (FPT\_TST.1.1): during initial start-up, periodically during normal operation.

Note: during initial start-up means before code is executed (and not necessarily during Answer To Reset procedure).

RLB\_301 The TOE's self tests shall include the verification of the integrity of any software code not stored in ROM.

RLB\_302 Upon detection of a self test error the TSF shall warn the entity connected.

RLB\_303 After OS testing is completed, all testing-specific commands and actions shall be disabled or removed. It shall not be possible to override these controls and restore them for use. Command associated exclusively with one life cycle state shall never be accessed during another state.

##### 4.7.2. *Software*

RLB\_304 There shall be no way to analyse, debug or modify TOE's software in the field.

RLB\_305 Inputs from external sources shall not be accepted as executable code.

##### 4.7.3. *Power supply*

RLB\_306 The TOE shall preserve a secure state during power supply cut-off or variations.

##### 4.7.4. *Reset conditions*

RLB\_307 If power is cut (or if power variations occur) from the TOE, or if a transaction is stopped before completion, or on any other reset conditions, the TOE shall be reset cleanly.

#### 4.8. **Data exchange**

##### 4.8.1. *Data exchange with a vehicle unit*

DEX\_301 The TOE shall verify the integrity and authenticity of data imported from a vehicle unit.

DEX\_302 Upon detection of an imported data integrity error, the TOE shall:

- warn the entity sending the data,
- not use the data.

DEX\_303 The TOE shall export user data to the vehicle unit with associated security attributes, such that the vehicle unit will be able to verify the integrity and authenticity of data received.

##### 4.8.2. *Export of data to a non-vehicle unit (download function)*

DEX\_304 The TOE shall be able to generate an evidence of origin for data downloaded to external media.

DEX\_305 The TOE shall be able to provide a capability to verify the evidence of origin of downloaded data to the recipient.

DEX\_306 The TOE shall be able to download data to external storage media with associated security attributes such that downloaded data integrity can be verified.

#### 4.9. **Cryptographic support**

CSP\_301 If the TSF generates cryptographic keys, it shall be in accordance with specified cryptographic key generation algorithms and specified cryptographic key sizes. Generated cryptographic session keys shall have a limited (TBD by manufacturer and not more than 240) number of possible use.

CSP\_302 If the TSF distributes cryptographic keys, it shall be in accordance with specified cryptographic key distribution methods.

#### 5. **Definition of security mechanisms**

Required security mechanisms are specified in Appendix 11.

All other security mechanisms are to be defined by the TOE manufacturer.



## Appendix 11

**COMMON SECURITY MECHANISMS**

## CONTENTS

|        |                                                                                      |     |
|--------|--------------------------------------------------------------------------------------|-----|
| 1.     | Generalities .....                                                                   | 238 |
| 1.1.   | References .....                                                                     | 238 |
| 1.2.   | Notations and abbreviated terms .....                                                | 239 |
| 2.     | Cryptographic systems and algorithms .....                                           | 240 |
| 2.1.   | Cryptographic systems .....                                                          | 240 |
| 2.2.   | Cryptographic algorithms .....                                                       | 240 |
| 2.2.1. | RSA algorithm .....                                                                  | 240 |
| 2.2.2. | Hash algorithm .....                                                                 | 240 |
| 2.2.3. | Data encryption algorithm .....                                                      | 240 |
| 3.     | Keys and certificates .....                                                          | 240 |
| 3.1.   | Keys generation and distribution .....                                               | 240 |
| 3.1.1. | RSA keys generation and distribution .....                                           | 240 |
| 3.1.2. | RSA test keys .....                                                                  | 242 |
| 3.1.3. | Motion sensor keys .....                                                             | 242 |
| 3.1.4. | T-DES session keys generation and distribution .....                                 | 242 |
| 3.2.   | Keys .....                                                                           | 242 |
| 3.3.   | Certificates .....                                                                   | 242 |
| 3.3.1. | Certificates content .....                                                           | 243 |
| 3.3.2. | Certificates issued .....                                                            | 244 |
| 3.3.3. | Certificate verification and unwrapping .....                                        | 245 |
| 4.     | Mutual authentication mechanism .....                                                | 245 |
| 5.     | VU-cards data transfer confidentiality, integrity and authentication mechanism ..... | 248 |
| 5.1.   | Secure messaging .....                                                               | 248 |
| 5.2.   | Treatment of secure messaging errors .....                                           | 249 |
| 5.3.   | Algorithm to compute cryptographic checksums .....                                   | 250 |
| 5.4.   | Algorithm to compute cryptograms for confidentiality DOs .....                       | 250 |
| 6.     | Data download digital signature mechanisms .....                                     | 251 |
| 6.1.   | Signature generation .....                                                           | 251 |
| 6.2.   | Signature verification .....                                                         | 251 |

## 1. GENERALITIES

This appendix specifies the security mechanisms ensuring:

- the mutual authentication between VUs and tachograph cards, including session key agreement,
- the confidentiality, integrity and authentication of data transferred between VUs and tachograph cards,
- the integrity and authentication of data downloaded from VUs to external storage media,
- the integrity and authentication of data downloaded from tachograph cards to external storage media.

### 1.1. References

The following references are used in this Appendix:

|                |                                                                                                                                                                                       |
|----------------|---------------------------------------------------------------------------------------------------------------------------------------------------------------------------------------|
| SHA-1          | National Institute of Standards and Technology (NIST). FIPS Publication 180-1: Secure Hash Standard. April 1995                                                                       |
| PKCS1          | RSA Laboratories. PKCS # 1: RSA Encryption Standard. Version 2.0. October 1998                                                                                                        |
| TDES           | National Institute of Standards and Technology (NIST). FIPS Publication 46-3: Data Encryption Standard. Draft 1999                                                                    |
| TDES-OP        | ANSI X9.52, Triple Data Encryption Algorithm Modes of Operation. 1998                                                                                                                 |
| ISO/IEC 7816-4 | Information Technology — Identification cards — Integrated circuit(s) cards with contacts — Part 4: Interindustry commands for interexchange. First edition: 1995 + Amendment 1: 1997 |
| ISO/IEC 7816-6 | Information Technology — Identification cards — Integrated circuit(s) cards with contacts — Part 6: Interindustry data elements. First edition: 1996 + Cor 1: 1998                    |
| ISO/IEC 7816-8 | Information Technology — Identification cards — Integrated circuit(s) cards with contacts — Part 8: Security related interindustry commands. First edition 1999                       |
| ISO/IEC 9796-2 | Information Technology — Security techniques — Digital signature schemes giving message recovery — Part 2: Mechanisms using a hash function. First edition: 1997                      |
| ISO/IEC 9798-3 | Information Technology — Security techniques — Entity authentication mechanisms — Part 3: Entity authentication using a public key algorithm. Second edition 1998                     |
| ISO 16844-3    | Road vehicles — Tachograph systems — Part 3: Motion sensor interface.                                                                                                                 |

## 1.2. Notations and abbreviated terms

The following notations and abbreviated terms are used in this Appendix:

|                   |                                                                                                                                                                                                                                                                                                                                       |
|-------------------|---------------------------------------------------------------------------------------------------------------------------------------------------------------------------------------------------------------------------------------------------------------------------------------------------------------------------------------|
| $(K_a, K_b, K_c)$ | a key bundle for use by the triple data encryption algorithm                                                                                                                                                                                                                                                                          |
| CA                | Certification authority                                                                                                                                                                                                                                                                                                               |
| CAR               | Certification authority reference                                                                                                                                                                                                                                                                                                     |
| CC                | Cryptographic checksum                                                                                                                                                                                                                                                                                                                |
| CG                | Cryptogram                                                                                                                                                                                                                                                                                                                            |
| CH                | Command header                                                                                                                                                                                                                                                                                                                        |
| CHA               | Certificate holder authorisation                                                                                                                                                                                                                                                                                                      |
| CHR               | Certificate holder reference                                                                                                                                                                                                                                                                                                          |
| $D()$             | Decryption with DES                                                                                                                                                                                                                                                                                                                   |
| DE                | Data element                                                                                                                                                                                                                                                                                                                          |
| DO                | Data object                                                                                                                                                                                                                                                                                                                           |
| $d$               | RSA private key, private exponent                                                                                                                                                                                                                                                                                                     |
| $e$               | RSA public key, public exponent                                                                                                                                                                                                                                                                                                       |
| $E()$             | Encryption with DES                                                                                                                                                                                                                                                                                                                   |
| EQT               | Equipment                                                                                                                                                                                                                                                                                                                             |
| <i>Hash()</i>     | hash value, an output of <i>hash</i>                                                                                                                                                                                                                                                                                                  |
| <i>Hash</i>       | hash function                                                                                                                                                                                                                                                                                                                         |
| KID               | Key identifier                                                                                                                                                                                                                                                                                                                        |
| $K_m$             | TDES key. Master Key defined in ISO 16844-3                                                                                                                                                                                                                                                                                           |
| $K_{m_{vu}}$      | TDES key inserted in vehicle units                                                                                                                                                                                                                                                                                                    |
| $K_{m_{wc}}$      | TDES key inserted in workshop cards                                                                                                                                                                                                                                                                                                   |
| $m$               | message representative an integer between 0 and $n-1$                                                                                                                                                                                                                                                                                 |
| $n$               | RSA keys, modulus                                                                                                                                                                                                                                                                                                                     |
| PB                | Padding bytes                                                                                                                                                                                                                                                                                                                         |
| PI                | Padding indicator byte (for use in cryptogram for confidentiality DO)                                                                                                                                                                                                                                                                 |
| PV                | Plain value                                                                                                                                                                                                                                                                                                                           |
| $s$               | signature representative, an integer between 0 and $n-1$                                                                                                                                                                                                                                                                              |
| SSC               | Send sequence counter                                                                                                                                                                                                                                                                                                                 |
| SM                | Secure messaging                                                                                                                                                                                                                                                                                                                      |
| TCBC              | TDEA cipher block chaining mode of operation                                                                                                                                                                                                                                                                                          |
| TDEA              | Triple data encryption algorithm                                                                                                                                                                                                                                                                                                      |
| TLV               | Tag length value                                                                                                                                                                                                                                                                                                                      |
| VU                | Vehicle unit                                                                                                                                                                                                                                                                                                                          |
| X.C               | the certificate of user X issued by a certification authority                                                                                                                                                                                                                                                                         |
| X.CA              | a certification authority of user X                                                                                                                                                                                                                                                                                                   |
| $X.CA.PK_oX.C$    | the operation of unwrapping a certificate to extract a public key. It is an infix operator, whose left operand is the public key of a certification authority, and whose right operand is the certificate issued by that certification authority. The outcome is the public key of the user X whose certificate is the right operand, |

|         |                                                                         |
|---------|-------------------------------------------------------------------------|
| X.PK    | public key of a user X                                                  |
| X.PK[I] | RSA encipherment of some information I, using the public key of user X  |
| X.SK    | RSA private key of a user X                                             |
| X.SK[I] | RSA encipherment of some information I, using the private key of user X |
| 'xx'    | a Hexadecimal value                                                     |
|         | concatenation operator.                                                 |

## 2. CRYPTOGRAPHIC SYSTEMS AND ALGORITHMS

### 2.1. Cryptographic systems

CSM\_001 Vehicle units and tachograph cards shall use a classical RSA public-key cryptographic system to provide the following security mechanisms:

- authentication between vehicle units and cards,
- transport of Triple-DES session keys between vehicle units and tachograph cards,
- digital signature of data downloaded from vehicle units or tachograph cards to external media.

CSM\_002 Vehicle units and tachograph cards shall use a Triple DES symmetric cryptographic system to provide a mechanism for data integrity during user data exchange between vehicle units and tachograph cards, and to provide, where applicable, confidentiality of data exchange between vehicle units and tachograph cards.

### 2.2. Cryptographic algorithms

#### 2.2.1. RSA algorithm

CSM\_003 The RSA algorithm is fully defined by the following relations:

$$\begin{aligned} X.SK[m] &= s = m^d \text{ mod } n \\ X.PK[s] &= m = s^e \text{ mod } n \end{aligned}$$

A more comprehensive description of the RSA function can be found in reference (PKCS1).

Public exponent, e, for RSA calculations will be different from 2 in all generated RSA keys.

#### 2.2.2. Hash algorithm

CSM\_004 The digital signature mechanisms shall use the SHA-1 hash algorithm as defined in reference (SHA-1).

#### 2.2.3. Data encryption algorithm

CSM\_005 DES based algorithms shall be used in Cipher Block Chaining mode of operation.

## 3. KEYS AND CERTIFICATES

### 3.1. Keys generation and distribution

#### 3.1.1. RSA keys generation and distribution

CSM\_006 RSA keys shall be generated through three functional hierarchical levels:

- European level,
- Member State level,
- Equipment level.



CSM\_007 At European level, a single European key pair (EUR.SK and EUR.PK) shall be generated. The European private key shall be used to certify the Member States public keys. Records of all certified keys shall be kept. These tasks shall be handled by a European certification authority, under the authority and responsibility of the European Commission.

CSM\_008 At Member State level, a Member State key pair (MS.SK and MS.PK) shall be generated. Member States public keys shall be certified by the European Certification Authority. The Member State private key shall be used to certify public keys to be inserted in equipment (vehicle unit or tachograph card). Records of all certified public keys shall be kept with the identification of the equipment to which it is intended. These tasks shall be handled by a Member State certification authority. A Member State may regularly change its key pair.

CSM\_009 At equipment level, one single key pair (EQT.SK and EQT.PK) shall be generated and inserted in each equipment. Equipment public keys shall be certified by a Member State certification authority. These tasks may be handled by equipment manufacturers, equipment personalisers or Member State authorities. This key pair is used for authentication, digital signature and encipherment services

CSM\_010 Private keys confidentiality shall be maintained during generation, transport (if any) and storage.

The following picture summarises the data flow of this process:

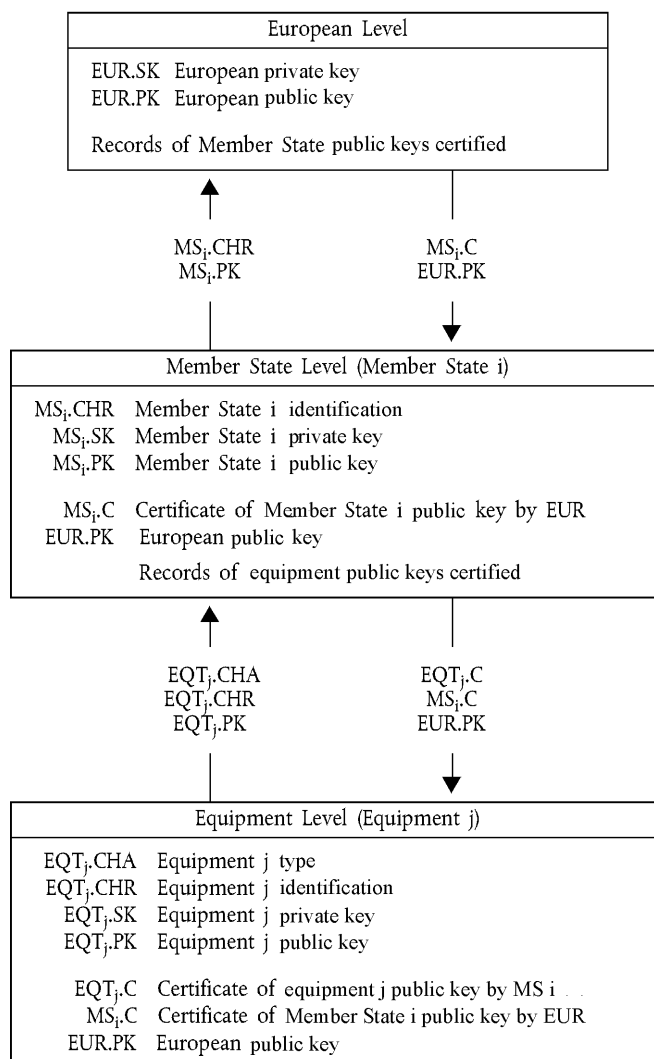

### 3.1.2. *RSA test keys*

CSM\_011 For the purpose of equipment testing (including interoperability tests) the European certification authority shall generate a different single European test key pair and at least two Member State test key pairs, the public keys of which shall be certified with the European private test key. Manufacturers shall insert, in equipment undergoing type approval tests, test keys certified by one of these Member State test keys.

### 3.1.3. *Motion sensor keys*

The confidentiality of the three TDES keys described below shall be appropriately maintained during generation, transport (if any) and storage.

In order to support recording equipment compliant with ISO 16844, the European certification authority and the Member State certification authorities shall, in addition, ensure the following:

CSM\_036 The European certification authority shall generate  $K_{m_{VU}}$  and  $K_{m_{WC}}$ , two independent and unique Triple DES keys, and generate  $K_m$  as:

$$K_m = K_{m_{VU}} \text{ XOR } K_{m_{WC}}$$

The European certification authority shall forward these keys, under appropriately secured procedures, to Member States certification authorities at their request.

CSM\_037 Member States certification authorities shall:

- use  $K_m$  to encrypt motion sensor data requested by motion sensor manufacturers (data to be encrypted with  $K_m$  is defined in ISO 16844-3),
- forward  $K_{m_{VU}}$  to vehicle unit manufacturers, under appropriately secured procedures, for insertion in vehicle units,
- ensure that  $K_{m_{WC}}$  will be inserted in all workshop cards (`SensorInstallationSecData` in `Sensor_Installation_Data` elementary file) during card personalisation.

### 3.1.4. *T-DES session keys generation and distribution*

CSM\_012 Vehicle units and tachograph cards shall, as a part of the mutual authentication process, generate and exchange necessary data to elaborate a common Triple DES session key. This exchange of data shall be protected for confidentiality through an RSA crypt-mechanism.

CSM\_013 This key shall be used for all subsequent cryptographic operations using secure messaging. Its validity shall expire at the end of the session (withdrawal of the card or reset of the card) and/or after 240 use (one use of the key = one command using secure messaging sent to the card and associated response).

## 3.2. **Keys**

CSM\_014 RSA keys shall have (whatever the level) the following lengths: modulus  $n$  1024 bits, public exponent  $e$  64 bits maximum, private exponent  $d$  1024 bits.

CSM\_015 Triple DES keys shall have the form  $(K_a, K_b, K_a)$  where  $K_a$  and  $K_b$  are independent 64 bits long keys. No parity error detecting bits shall be set.

## 3.3. **Certificates**

CSM\_016 RSA Public key certificates shall be "non self-descriptive" "Card Verifiable" certificates (Ref.: ISO/IEC 7816-8)

### 3.3.1. Certificates content

CSM\_017 RSA Public key certificates are built with the following data in the following order:

| Data     | Format       | Bytes | Obs                                                            |
|----------|--------------|-------|----------------------------------------------------------------|
| CPI      | INTEGER      | 1     | Certificate profile identifier ('01' for this version)         |
| CAR      | OCTET STRING | 8     | Certification authority reference                              |
| CHA      | OCTET STRING | 7     | Certificate holder authorisation                               |
| EOV      | TimeReal     | 4     | Certificate end of validity. Optional, 'FF' padded if not used |
| CHR      | OCTET STRING | 8     | Certificate holder reference                                   |
| <i>n</i> | OCTET STRING | 128   | Public key (modulus)                                           |
| <i>e</i> | OCTET STRING | 8     | Public key (public exponent)                                   |
|          |              | 164   |                                                                |

Notes:

1. The "Certificate Profile Identifier" (CPI) delineates the exact structure of an authentication certificate. It can be used as an equipment internal identifier of a relevant headerlist which describes the concatenation of Data Elements within the certificate.

The headerlist associated with this certificate content is as follows:

| '4D'                    | '16'                  | '5F 29' | '01'       | '42'    | '08'       | '5F 4B' | '07'       | '5F 24' | '04'       | '5F 20' | '08'       | '7F 49'                      | '05'                     | '81'        | '81 80'        | '82'                | '08'                   |
|-------------------------|-----------------------|---------|------------|---------|------------|---------|------------|---------|------------|---------|------------|------------------------------|--------------------------|-------------|----------------|---------------------|------------------------|
| Extended headerlist Tag | Length of header list | CPI Tag | CPI Length | CAR Tag | CAR Length | CHA Tag | CHA Length | EOV Tag | EOV Length | CHR Tag | CHR Length | Public key Tag (constructed) | Length of subsequent DOs | modulus Tag | modulus length | public exponent Tag | public exponent length |

2. The "Certification Authority Reference" (CAR) has the purpose of identifying the certificate issuing CA, in such a way that the data element can be used at the same time as an authority key identifier to reference the public key of the certification authority (for coding, see Key Identifier below).
3. The "Certificate Holder Authorisation" ((CHA) is used to identify the rights of the certificate holder. It consists of the Tachograph Application ID and of the type of equipment to which the certificate is intended (according to EquipmentType data element, "00" for a Member State).
4. "Certificate Holder Reference" (CHR) has the purpose of identifying uniquely the certificate holder, in such a way that the Data Element can be used at the same time as a Subject Key Identifier to reference the Public Key of the certificate holder.
5. Key Identifiers uniquely identify certificate holder or certification authorities. They are coded as follows:

#### 5.1. Equipment (VU or Card):

| Data   | Equipment serial number | Date             | Type                  | Manufacturer      |
|--------|-------------------------|------------------|-----------------------|-------------------|
| Length | 4 Bytes                 | 2 Bytes          | 1 Byte                | 1 Byte            |
| Value  | Integer                 | mm yy BCD coding | Manufacturer specific | Manufacturer code |

In the case of a VU, the manufacturer, when requesting certificates, may or may not know the identification of the equipment in which the keys will be inserted.

In the first case, the manufacturer will send the equipment identification with the public key to its Member State authority for certification. The certificate will then contain the equipment identification, and the manufacturer must ensure that keys and certificate are inserted in the intended equipment. The Key identifier has the form shown above.

In the later case, the manufacturer must uniquely identify each certificate request and send this identification with the public key to its Member State authority for certification. The certificate will contain the request identification. The manufacturer must feed back its Member State authority with the assignment of key to equipment (i.e. certificate request identification, equipment identification) after key installation in the equipment. The key identifier has the following form:

|        |                                   |                  |        |                   |
|--------|-----------------------------------|------------------|--------|-------------------|
| Data   | Certificate request serial number | Date             | Type   | Manufacturer      |
| Length | 4 Bytes                           | 2 Bytes          | 1 Byte | 1 Byte            |
| Value  | BCD coding                        | mm jj BCD coding | 'FF'   | Manufacturer code |

#### 5.2. Certification Authority:

|        |                                                                    |                   |                                                        |            |
|--------|--------------------------------------------------------------------|-------------------|--------------------------------------------------------|------------|
| Data   | Authority identification                                           | Key serial number | Additional info                                        | Identifier |
| Length | 4 Bytes                                                            | 1 Byte            | 2 Bytes                                                | 1 Byte     |
| Value  | 1 Byte nation numerical code<br>3 Bytes nation alphanumerical code | Integer           | additional coding (CA specific)<br>'FF FF' if not used | '01'       |

The key serial number is used to distinguish the different keys of a Member State, in the case the key is changed.

6. Certificate verifiers shall implicitly know that the public key certified is an RSA key relevant to authentication, digital signature verification and encipherment for confidentiality services (the certificate contains no Object Identifier to specify it).

#### 3.3.2. Certificates issued

CSM\_018 The certificate issued is a digital signature with partial recovery of the certificate content in accordance with ISO/IEC 9796-2, with the "Certification Authority Reference" appended.

$$X.C = X.CA.SK['6A' || C_r || Hash(Cc) || 'BC'] || C_n || X.CAR$$

With certificate content = Cc =  $\begin{matrix} C_r \\ 106 \text{ Bytes} \end{matrix} || \begin{matrix} C_n \\ 58 \text{ Bytes} \end{matrix}$

Notes:

1. This certificate is 194 bytes long.
2. CAR, being hidden by the signature, is also appended to the signature, such that the public key of the certification authority may be selected for the verification of the certificate.
3. The certificate verifier shall implicitly know the algorithm used by the certification authority to sign the certificate.

4. The headerlist associated with this issued certificate is as follows:

|                                     |                          |               |                  |               |                  |         |            |
|-------------------------------------|--------------------------|---------------|------------------|---------------|------------------|---------|------------|
| '7F 21'                             | '09'                     | '5F 37'       | '81 80'          | '5F 38'       | '3A'             | '42'    | '08'       |
| CV Certificate Tag<br>(Constructed) | Length of subsequent DOs | Signature Tag | Signature length | Remainder Tag | Remainder length | CAR Tag | CAR length |

### 3.3.3. Certificate verification and unwrapping

Certificate verification and unwrapping consists in verifying the signature in accordance with ISO/IEC 9796-2, retrieving the certificate content and the public key contained:  $X.PK = X.CA.PK_0X.C$ , and verifying the validity of the certificate.

CSM\_019 It involves the following steps:

verify signature and retrieve content:

- from X.C retrieve Sign,  $C_n'$  and CAR':  $X.C = \underset{128 \text{ Bytes}}{\text{Sign}} \parallel \underset{58 \text{ Bytes}}{C_n'} \parallel \underset{8 \text{ Bytes}}{\text{CAR}'}$
- from CAR' select appropriate Certification Authority Public Key (if not done before through other means)
- open Sign with CA Public Key:  $Sr' = X.CA.PK [\text{Sign}]$ ,
- check  $Sr'$  starts with '6A' and ends with 'BC'
- compute  $Cr'$  and  $H'$  from:  $Sr' = \text{'6A'} \parallel \underset{106 \text{ Bytes}}{Cr'} \parallel \underset{20 \text{ Bytes}}{H'} \parallel \text{'BC'}$
- Recover certificate content  $C' = Cr' \parallel C_n'$ ,
- check  $\text{Hash}(C') = H'$

If the checks are OK the certificate is a genuine one, its content is  $C'$ .

Verify validity. From  $C'$ :

- if applicable, check End of validity date,

Retrieve and store public key, Key Identifier, Certificate Holder Authorisation and Certificate End of Validity from  $C'$ :

- $X.PK = n \parallel e$
- $X.KID = CHR$
- $X.CHA = CHA$
- $X.EOV = EO.V$ .

## 4. MUTUAL AUTHENTICATION MECHANISM

Mutual authentication between cards and VUs is based on the following principle:

Each party shall demonstrate to the other that it owns a valid key pair, the public key of which has been certified by a Member State certification authority, itself being certified by the European certification authority.

Demonstration is made by signing with the private key a random number sent by the other party, who must recover the random number sent when verifying this signature.

The mechanism is triggered at card insertion by the VU. It starts with the exchange of certificates and unwrapping of public keys, and ends with the setting of a session key.

CSM\_020 The following protocol shall be used (arrows indicate commands and data exchanged (see Appendix 2)):

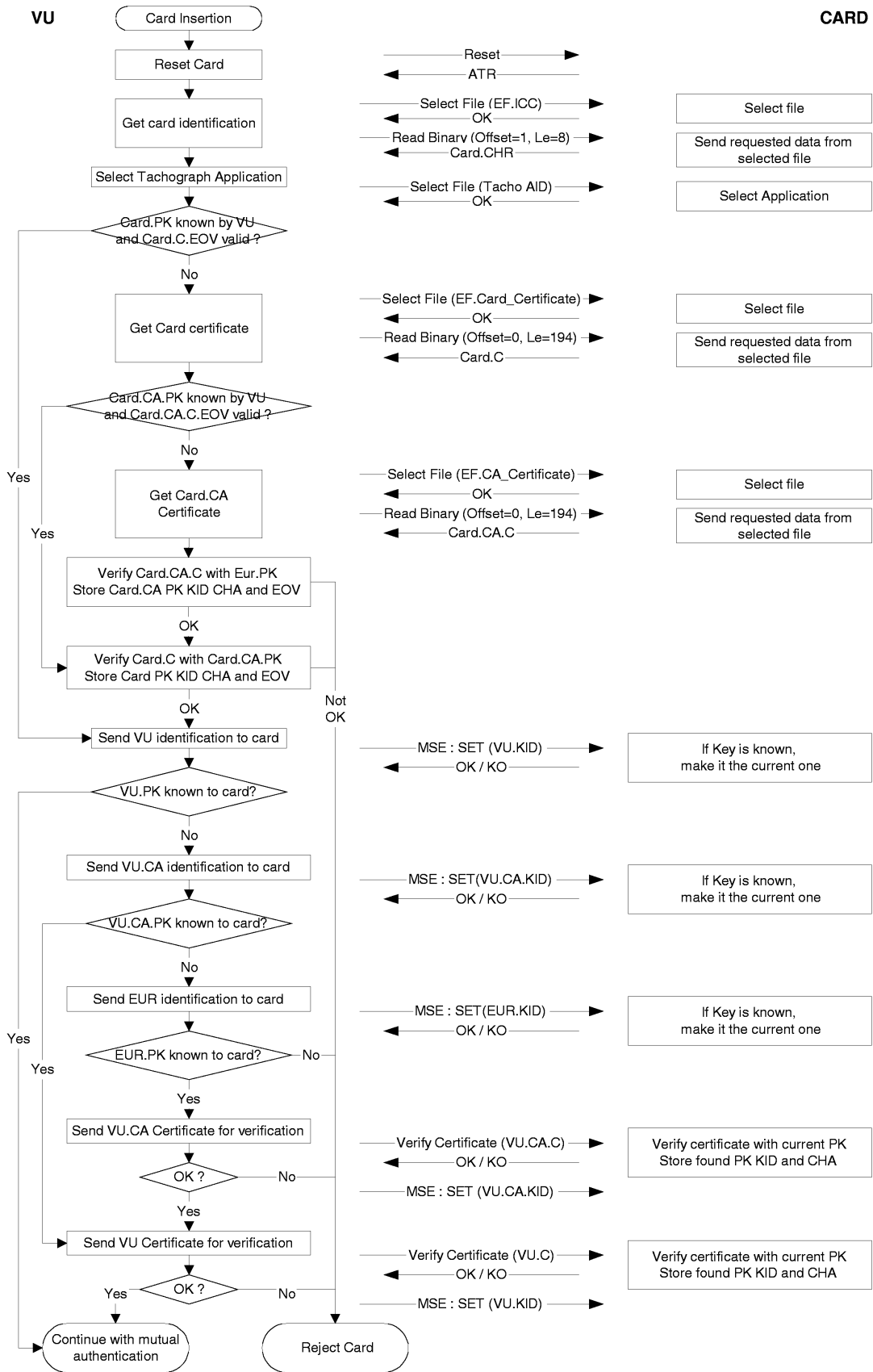

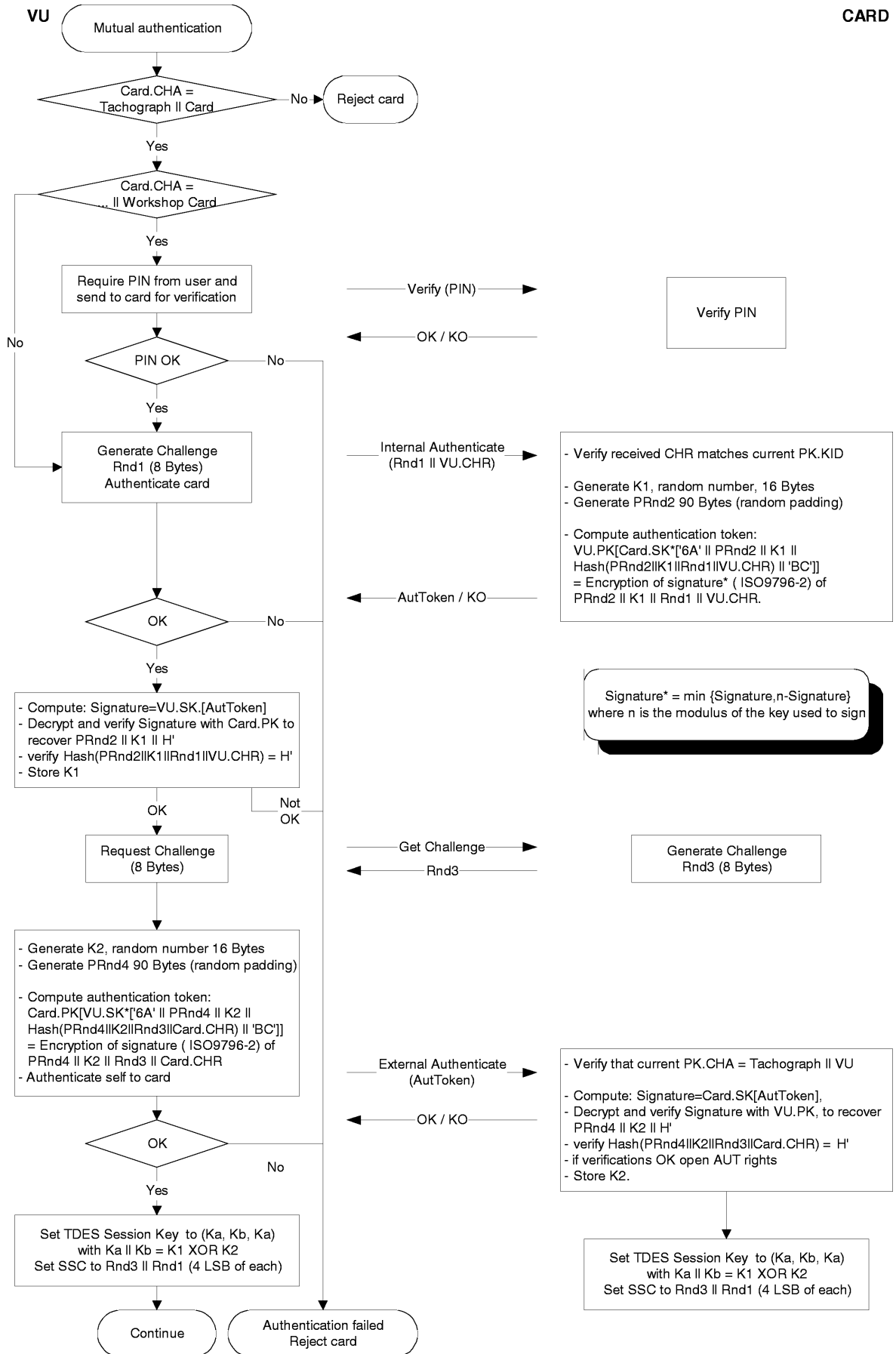

## 5. VU-CARDS DATA TRANSFER CONFIDENTIALITY, INTEGRITY AND AUTHENTICATION MECHANISMS

## 5.1. Secure messaging

- CSM\_021 VU-cards data transfers integrity shall be protected through Secure Messaging in accordance with references (ISO/IEC 7816-4) and (ISO/IEC 7816-8).
- CSM\_022 When data need to be protected during transfer, a cryptographic checksum data object shall be appended to the data objects sent within the command or the response. The cryptographic checksum shall be verified by the receiver.
- CSM\_023 The cryptographic checksum of data sent within a command shall integrate the command header, and all data objects sent ( $= > \text{CLA} = '0C'$ , and all data objects shall be encapsulated with tags in which  $b_1 = 1$ ).
- CSM\_024 The response status-information bytes shall be protected by a cryptographic checksum when the response contains no data field.
- CSM\_025 Cryptographic checksums shall be four bytes long.

The structure of commands and responses when using secure messaging is therefore the following:

The DOs used are a partial set of the Secure Messaging DOs described in ISO/IEC 7816-4:

| Tag  | Mnemonic           | Meaning                                                                  |
|------|--------------------|--------------------------------------------------------------------------|
| '81' | T <sub>PV</sub>    | Plain Value not BER-TLV coded data (to be protected by CC)               |
| '97' | T <sub>LE</sub>    | Value of L <sub>e</sub> in the unsecured command (to be protected by CC) |
| '99' | T <sub>SW</sub>    | Status-Info (to be protected by CC)                                      |
| '8E' | T <sub>CC</sub>    | Cryptographic Checksum                                                   |
| '87' | T <sub>PI CG</sub> | Padding Indicator Byte    Cryptogram (Plain Value not coded in BER-TLV)  |

Given an unsecured command response pair:

| Command header | Command body                                                 |
|----------------|--------------------------------------------------------------|
| CLA INS P1 P2  | (L <sub>c</sub> -field) (Data field) (L <sub>e</sub> -field) |
| four bytes     | L bytes, denoted as B <sub>1</sub> to B <sub>L</sub>         |

| Response body             | Response trailer |
|---------------------------|------------------|
| (Data field)              | SW1 SW2          |
| L <sub>r</sub> data bytes | two bytes        |

The corresponding secured command response pair is:

Secured command:

| Command header (CH) | Command body               |                 |                 |                  |                 |                 |                |                 |                 |    |                            |
|---------------------|----------------------------|-----------------|-----------------|------------------|-----------------|-----------------|----------------|-----------------|-----------------|----|----------------------------|
| CLA INS P1 P2       | (New L <sub>c</sub> field) |                 |                 | (New Data field) |                 |                 |                |                 |                 |    | (New L <sub>e</sub> field) |
| '0C'                | Length of new data field   | T <sub>PV</sub> | L <sub>PV</sub> | PV               | T <sub>LE</sub> | L <sub>LE</sub> | L <sub>e</sub> | T <sub>CC</sub> | L <sub>CC</sub> | CC | '00'                       |
|                     |                            | '81'            | L <sub>c</sub>  | Data field       | '97'            | '01'            | L <sub>e</sub> | '8E'            | '04'            | CC |                            |



Data to be integrated in checksum = CH || PB || T<sub>PV</sub> || L<sub>PV</sub> || PV || T<sub>LE</sub> || L<sub>LE</sub> || L<sub>e</sub> || PB

PB = padding bytes (80 .. 00) in accordance with ISO-IEC 7816-4 and ISO 9797 method 1.

DOs PV and LE are present only when there is some corresponding data in the unsecured command.

Secured response:

1. Case where response data field is not empty and needs not to be protected for confidentiality:

|                  |                 |            |                 |                 |    |                  |
|------------------|-----------------|------------|-----------------|-----------------|----|------------------|
| Response body    |                 |            |                 |                 |    | Response trailer |
| (New data field) |                 |            |                 |                 |    | new SW1 SW2      |
| T <sub>PV</sub>  | L <sub>PV</sub> | PV         | T <sub>CC</sub> | L <sub>CC</sub> | CC |                  |
| '81'             | L <sub>r</sub>  | Data field | '8E'            | '04'            | CC |                  |

Data to be integrated in checksum = T<sub>PV</sub> || L<sub>PV</sub> || PV || PB

2. Case where response data field is not empty and needs to be protected for confidentiality:

|                    |                    |          |                 |                 |    |                  |
|--------------------|--------------------|----------|-----------------|-----------------|----|------------------|
| Response body      |                    |          |                 |                 |    | Response trailer |
| (New data field)   |                    |          |                 |                 |    | new SW1 SW2      |
| T <sub>PI CG</sub> | L <sub>PI CG</sub> | PI CG    | T <sub>CC</sub> | L <sub>CC</sub> | CC |                  |
| '87'               |                    | PI    CG | '8E'            | '04'            | CC |                  |

Data to be carried by CG: non BER-TLV coded data and padding bytes.

Data to be integrated in checksum = T<sub>PI CG</sub> || L<sub>PI CG</sub> || PI CG || PB

3. Case where response data field is empty:

|                  |                 |             |                 |                 |    |                  |
|------------------|-----------------|-------------|-----------------|-----------------|----|------------------|
| Response body    |                 |             |                 |                 |    | Response trailer |
| (New data field) |                 |             |                 |                 |    | new SW1 SW2      |
| T <sub>SW</sub>  | L <sub>SW</sub> | SW          | T <sub>CC</sub> | L <sub>CC</sub> | CC |                  |
| '99'             | '02'            | New SW1 SW2 | '8E'            | '04'            | CC |                  |

Data to be integrated in checksum = T<sub>SW</sub> || L<sub>SW</sub> || SW || PB

## 5.2. Treatment of secure messaging errors

CSM\_026 When the tachograph card recognises an SM error while interpreting a command, then the status bytes must be returned without SM. In accordance with ISO/IEC 7816-4, the following status bytes are defined to indicate SM errors:

'66 88' verification of cryptographic checksum failed,

'69 87' expected SM data objects missing,

'69 88' SM data objects incorrect.

CSM\_027 When the tachograph card returns status bytes without SM DOs or with an erroneous SM DO, the session must be aborted by the VU.

**5.3. Algorithm to compute cryptographic checksums**

CSM\_028 Cryptographic checksums are built using a retail MACs in accordance with ANSI X9.19 with DES:

- initial stage: the initial check block  $y_0$  is  $E(K_a, SSC)$ .
- sequential stage: the check blocks  $y_1, \dots, y_n$  are calculated using  $K_a$ .
- final stage: the cryptographic checksum is calculated from the last check block  $y_n$  as follows:  $E(K_a, D(K_b, y_n))$ .

where  $E()$  means encryption with DES, and  $D()$  means decryption with DES.

The four most significant bytes of the cryptographic checksum are transferred

CSM\_029 The send sequence counter (SSC) shall be initiated during key agreement procedure to:

Initial SSC: Rnd3 (4 least significant bytes) || Rnd1 (4 least significant bytes).

CSM\_030 The send sequence counter shall be increased by 1 each time before a MAC is calculated (i.e. the SSC for the first command is Initial SSC + 1, the SSC for the first response is Initial SSC + 2).

The following figure shows the calculation of the retail MAC:

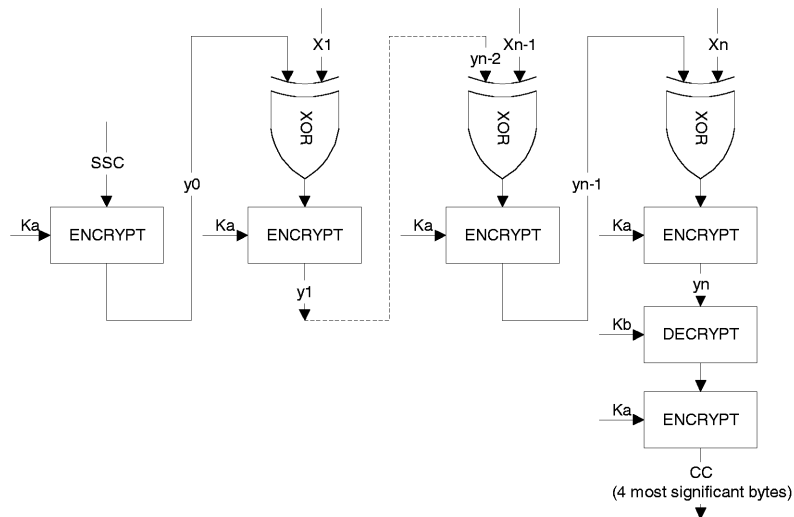

**5.4. Algorithm to compute cryptograms for confidentiality DOs**

CSM\_031 Cryptograms are computed using TDEA in TCBC mode of operation in accordance with references (TDES) and (TDES-OP) and with the Null vector as Initial Value block.

The following figure shows the application of keys in TDES:

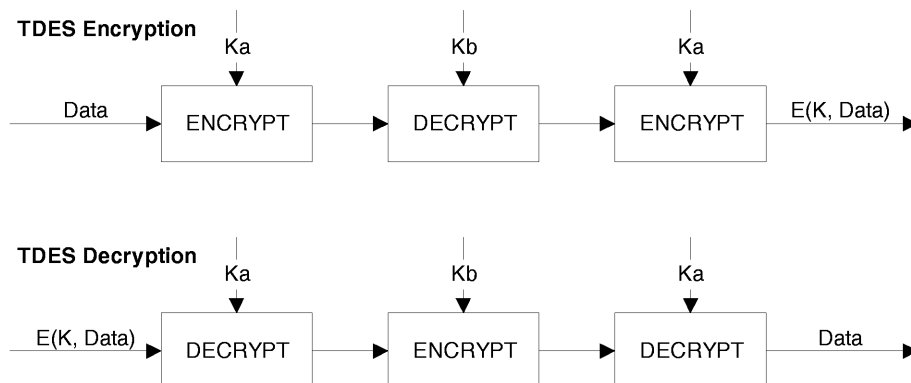

## 6. DATA DOWNLOAD DIGITAL SIGNATURE MECHANISMS

CSM\_032 The intelligent dedicated equipment (IDE) stores data received from an equipment (VU or card) during one download session within one physical data file. This file must contain the certificates MS<sub>i</sub>.C and EQT.C. The file contains digital signatures of data blocks as specified in Appendix 7 Data Downloading Protocols.

CSM\_033 Digital signatures of downloaded data shall use a digital signature scheme with appendix such, that downloaded data may be read without any decipherment if desired.

### 6.1. Signature generation

CSM\_034 Data signature generation by the equipment shall follow the signature scheme with appendix defined in reference (PKCS1) with the SHA-1 hash function:

$$\text{Signature} = \text{EQT.SK}[\text{'00'} \parallel \text{'01'} \parallel \text{PS} \parallel \text{'00'} \parallel \text{DER}(\text{SHA-1}(\text{Data}))]$$

PS Padding string of octets with value 'FF' such that length is 128.

DER(SHA-1(M)) is the encoding of the algorithm ID for the hash function and the hash value into an ASN.1 value of type *DigestInfo* (distinguished encoding rules):

'30' || '21' || '30' || '09' || '06' || '05' || '2B' || '0E' || '03' || '02' || '1A' || '05' || '00' || '04' || '14' || Hash Value.

### 6.2. Signature verification

CSM\_035 Data signature verification on downloaded data shall follow the signature scheme with appendix defined in reference (PKCS1) with the SHA-1 hash function.

The European public key EUR.PK needs to be known independently (and trusted) by the verifier.

The following table illustrates the protocol an IDE carrying a Control card can follow to verify the integrity of data downloaded and stored on the ESM (external storage media). The control card is used to perform the decipherment of digital signatures. This function may in this case not be implemented in the IDE.

The equipment that has downloaded and signed the data to be analysed is denoted EQT.

